



Emulated Virtual Environment
Next Generation

EVE-NG Professional Cookbook

Version 5.4

Author:
Uldis Dzerkals

Editors:
Michael Doe
Christopher Lim

© EVE-NG LTD

The information contained in this document is the property of EVE-NG Limited

The contents of the document must not be reproduced or disclosed wholly or in part or used for purposes other than that for which it is supplied without the prior written permission of EVE-NG Limited.

Table of Contents

PREFACE	9
1 INTRODUCTION	10
1.1 WHAT IS EVE-NG?	10
1.2 WHAT IS EVE-NG USED FOR?	10
1.3 WHO IS EVE-NG FOR?	10
2 SYSTEM REQUIREMENTS	11
2.1 HARDWARE REQUIREMENTS	11
2.1.1 <i>Minimal Laptop/PC Desktop system requirements</i>	11
2.1.2 <i>Recommended Laptop/PC Desktop system requirements</i>	12
2.1.3 <i>Virtual Server system requirements</i>	12
2.1.4 <i>Dedicated Server (bare metal BM) system requirements</i>	13
2.1.5 <i>Nodes per lab calculator</i>	13
2.1.6 <i>Hardcoded Subnets in the EVE</i>	13
2.2 SUPPORTED VIRTUALIZATION PLATFORMS AND SOFTWARE	13
2.3 UNSUPPORTED HARDWARE AND SYSTEMS	14
3 INSTALLATION	15
3.1 VMWARE WORKSTATION OR VM PLAYER	15
3.1.1 <i>VMware workstation EVE VM installation using ISO image (preferred)</i>	15
3.1.1.1 EVE VM Setup and Settings	15
3.1.1.2 EVE-NG VM Installation steps	19
3.1.2 <i>VMware workstation OVF deployment</i>	24
3.1.2.1 Deployment and VM machine settings	24
3.1.2.2 OVF VM update to the latest EVE version	26
3.1.2.3 OVF VM HDD Size expansion.....	26
3.2 VMWARE ESXi	26
3.2.1 <i>VMware ESXi EVE installation using ISO image (preferred)</i>	26
3.2.1.1 EVE-NG ESXi VM Setup and Settings	27
3.2.1.2 EVE-NG ESXi VM Installation steps	29
3.2.2 <i>VMware ESXi OVF deployment</i>	34
3.2.2.1 ESXi OVF VM Setup and Settings	34
3.2.2.2 ESXi OVF VM update to the latest EVE version	36
3.2.2.3 ESXi OVF VM HDD Size expansion	36
3.3 BARE HARDWARE (BM) SERVER EVE INSTALLATION	36
3.4 GOOGLE CLOUD PLATFORM.....	40
3.4.1 <i>Google account</i>	40
3.4.2 <i>Goggle Cloud project</i>	41
3.4.3 <i>Preparing Ubuntu boot disk template</i>	42
3.4.4 <i>Creating VM</i>	42
3.4.5 <i>EVE-NG Pro installation</i>	45
3.4.6 <i>Access to Google Cloud EVE-PRO</i>	46
3.4.7 <i>Optional: GCP Firewall rules for native console use</i>	47
3.5 EVE MANAGEMENT IP ADDRESS SETUP	49
3.5.1 <i>Management static IP address setup (preferred)</i>	49
3.5.2 <i>EVE Management IP address setup via DHCP</i>	52
3.5.3 <i>Internet proxy setup</i>	54
3.5.4 <i>EVE Management IP address reset</i>	55
3.6 NATIVE TELNET CONSOLE MANAGEMENT SETUP	55
3.6.1 <i>Windows Native Console</i>	55
3.6.2 <i>Linux Native Console</i>	56
3.6.3 <i>MAC OSX Native Console</i>	57
3.7 LOGIN TO THE EVE WEB GUI	57

4	EVE-NG PROFESSIONAL LICENSING	58
4.1	EVE-NG PROFESSIONAL BASE LICENSE	58
4.2	EVE-NG LEARNING CENTRE LICENSES	59
4.3	EVE-NG CORPORATE LICENSES.....	60
4.4	USER ROLES COMPARISON CHART	61
4.5	LICENSE PURCHASING AND ACTIVATION	62
4.6	LICENSE DEACTIVATION	64
4.7	LICENSE REHOSTING.....	65
5	EVE-NG PROFESSIONAL UPDATE & UPGRADE.....	66
5.1	EVE-NG PROFESSIONAL UPDATE.....	66
5.2	EVE-NG PROFESSIONAL UPGRADE	67
6	TYPES OF EVE MANAGEMENT CONSOLES.....	69
6.1	NATIVE CONSOLE	69
6.1.1	<i>Native Console: telnet.....</i>	69
6.1.2	<i>Native Console: Wireshark</i>	70
6.1.3	<i>Native Console: VNC.....</i>	71
6.1.4	<i>Native Console: RDP</i>	72
6.2	HTML5 CONSOLE.....	73
6.2.1	<i>HTML5 Console window functions</i>	73
6.2.2	<i>HTML5 Console: Telnet.....</i>	73
6.2.3	<i>HTML5 Console: Wireshark.....</i>	74
6.2.4	<i>HTML5 Console: VNC</i>	75
6.2.5	<i>HTML5 Console: RDP</i>	76
6.3	HTML5 DESKTOP CONSOLE	78
6.3.1	<i>Login to HTML5 Desktop console.....</i>	78
6.3.2	<i>HTML5 Desktop Console: telnet.....</i>	79
6.3.3	<i>HTML5 Desktop Console: Wireshark</i>	79
6.3.4	<i>HTML5 Desktop Console: RDP.....</i>	80
6.3.5	<i>HTML5 Desktop Console: ThinClient Files exchange</i>	80
7	EVE WEB GUI MANAGEMENT	81
7.1	EVE MANAGEMENT PAGE.....	81
7.1.1	<i>Management buttons</i>	81
7.1.2	<i>Management tabs</i>	82
7.2	FOLDERS AND LAB FILES MANAGEMENT	83
7.2.1	<i>Folders Management.....</i>	83
7.2.1.1	<i>Default folder Running.....</i>	83
7.2.1.2	<i>Default folder Shared</i>	84
7.2.1.3	<i>Default folder Users</i>	85
7.2.1.4	<i>Create folder</i>	85
7.2.1.5	<i>Delete folder</i>	85
7.2.1.6	<i>Move Folder</i>	86
7.2.1.7	<i>Export Folder.....</i>	86
7.2.1.8	<i>Import Folder</i>	86
7.2.2	<i>Lab files Management.....</i>	87
7.2.2.1	<i>Create Lab</i>	88
7.2.2.2	<i>Delete Lab</i>	88
7.2.2.3	<i>Clone Lab.....</i>	88
7.2.2.4	<i>Move Lab.....</i>	89
7.2.2.5	<i>Export Lab</i>	90
7.2.2.6	<i>Import Labs</i>	90
7.3	EVE MANAGEMENT DROPDOWN MENU	91
7.3.1	<i>EVE User management</i>	91
7.3.1.1	<i>Creating a new EVE User</i>	91
7.3.1.2	<i>Edit EVE User.....</i>	95
7.3.1.3	<i>User session termination</i>	96
7.3.1.4	<i>User monitoring</i>	97

7.3.1.5	User role sticky lab	97
7.3.2	EVE Node management	98
7.3.2.1	Node management actions	98
7.3.2.2	Node management filtering function	98
7.3.3	EVE Lab management	99
7.3.3.1	Lab management actions	100
7.4	EVE SYSTEM DROPDOWN MENU	100
7.4.1	System Settings	101
7.4.2	Cluster Management	103
7.4.3	System status	103
7.4.4	System logs	104
7.4.5	Stop All Nodes	104
7.5	EVE INFORMATION DROPDOWN MENU	105
7.6	EVE LICENSING DROPDOWN MENU	105
7.7	OTHER TAB LINE INFO	105
7.8	LAB PREVIEW AND GLOBAL SETTINGS	105
7.8.1	Lab preview window	106
7.8.2	Lab preview buttons	106
7.8.3	Lab preview information	107
7.8.4	Lab Global Settings	107
8	EVE WEB TOPOLOGY PAGE	109
8.1	SIDE BAR FUNCTIONS	109
8.1.1	Add an object	109
8.1.1.1	Node object	110
8.1.1.2	Network object	110
8.1.1.3	Picture object	111
8.1.1.4	Custom shape object	111
8.1.1.5	Text object	112
8.1.1.6	Line object	112
8.1.2	Nodes	112
8.1.3	Networks	114
8.1.4	Startup-configs	114
8.1.5	Logical Maps	115
8.1.6	Configured Objects	115
8.1.7	More actions	115
8.1.7.1	Start all nodes	116
8.1.7.2	Stop all nodes	116
8.1.7.3	Wipe all nodes	116
8.1.7.4	Console to All Nodes	117
8.1.7.5	Export all CFGs	117
8.1.7.6	Edit lab	117
8.1.7.7	Topology screenshot	117
8.1.7.8	Set node's startup-cfg to default configset	118
8.1.7.9	Set node's startup-cfg to none	118
8.1.7.10	Delete default startup-cfgs	118
8.1.8	Refresh Topology	118
8.1.9	Lab page zoom/unzoom	118
8.1.10	Status	118
8.1.11	Lab details	119
8.1.12	Lab Tasks	119
8.1.13	Lab Chat	119
8.1.14	Lock Lab with password	119
8.1.15	Fullscreen	120
8.1.16	Hide interface labels	120
8.1.17	Dark mode or Light mode	120
8.1.18	Close lab	121
8.1.19	Logout	121
8.2	EVE LAB TOPOLOGY MENUS	121

8.2.1	<i>Lab topology menu</i>	121
8.2.2	<i>Connection menu</i>	121
8.2.3	<i>Cloud or Bridge network menu</i>	121
8.2.4	<i>Stopped node menu</i>	122
8.2.5	<i>Running node menu</i>	123
8.2.6	<i>Selected nodes menu and features</i>	124
8.3	EVE LAB NODE STATES AND SYMBOLS	127
8.3.1	<i>Stopped (non-running) nodes</i>	127
8.3.2	<i>Running nodes</i>	127
8.3.3	<i>Node connector symbol</i>	128
8.4	OTHER	128
8.4.1	<i>Notifications area</i>	128
9	WORKING WITH EVE LABS	130
9.1	CREATING A LAB	130
9.1.1	<i>Adding nodes to the lab</i>	130
9.1.1.1	Node values Table	132
9.1.2	<i>Edit node</i>	135
9.1.2.1	Edit nodes globally	135
9.1.2.2	Edit node individually	135
9.1.3	<i>Wipe Node</i>	136
9.1.4	<i>Interconnecting nodes</i>	136
9.1.5	<i>Edit connection link style</i>	137
9.1.6	<i>Edit connection link quality</i>	138
9.1.7	<i>Suspend or resume link connection</i>	139
9.1.8	<i>Delete connection between nodes</i>	140
9.1.9	<i>Delete Node</i>	141
9.2	RUNNING LABS	141
9.2.1	<i>Starting lab</i>	141
9.2.2	<i>Interconnecting running nodes (hotlinks)</i>	142
9.2.3	<i>Link quality delay, packet loss, jitter and rate feature</i>	142
9.3	SAVING LABS	142
9.4	STOPPING LABS	142
9.5	START SAVED LAB	143
9.6	WORKING WITH MULTIPLE RUNNING LABS	143
9.7	IMPORTING LABS	143
9.8	EXPORTING LABS	143
9.9	DELETING LABS	143
9.10	MOVING LABS	143
9.11	SHARED PROJECT/LAB	143
9.11.1	<i>Create Lab share</i>	144
9.11.2	<i>Remove Lab share</i>	144
9.11.3	<i>Working with shared lab</i>	145
9.12	STICKY LAB	146
10	EVE CLOUDS AND NETWORKS	147
10.1	BRIDGE NETWORK	147
10.2	INTERNAL NETWORK	148
10.3	PRIVATE NETWORK	148
10.4	NAT NETWORK	149
10.5	MANAGEMENT CLOUD0 INTERFACE	150
10.6	REMOVE CLOUD INTERFACES	153
10.7	OTHER CLOUD INTERFACES	153
10.8	CONNECTING EXTERNAL VM MACHINES TO THE EVE LAB	154
10.8.1	<i>ESXi VM machines</i>	154
10.8.2	<i>VMWare workstation machines</i>	156
10.9	CONNECTING EVE LAB TO A PHYSICAL DEVICE	158
10.9.1	<i>ESXi EVE</i>	158

10.9.2	VMWare workstation EVE	160
10.9.3	Bare metal server EVE	162
11	ADVANCED EVE LAB FEATURES	164
11.1	LAB DESIGN OBJECTS.....	164
11.1.1	Custom shape.....	164
11.1.2	Resize square or circle objects.....	165
11.1.3	Text.....	165
11.1.4	Add picture to the topology.....	166
11.1.5	Custom object linking with telnet or other protocol.....	167
11.1.6	Line object.....	169
11.1.7	Nodes connection links design.....	170
11.1.8	Cloning objects and overlay positions.....	170
11.1.9	Objects Editing.....	170
11.1.10	Lock objects movement.....	171
11.2	CUSTOM DESIGN LOGICAL TOPOLOGY	171
11.2.1	Custom design upload.....	171
11.2.2	Custom topology mapping.....	172
11.2.3	Delete topology or mapping.....	173
11.3	MULTI-CONFIGURATION SETS EXPORT FEATURE.....	173
11.3.1	Supported nodes for configuration exports.....	174
11.3.2	Startup config management.....	175
11.3.2.1	Global commands.....	175
11.3.2.2	Individual node commands.....	175
11.3.2.3	Multiple selected nodes commands.....	176
11.3.2.4	Startup-configuration window.....	176
11.3.2.5	Startup-config window information.....	176
11.3.3	Export Default configuration set.....	178
11.3.4	Boot nodes from exported Default config set.....	179
11.3.5	Export new custom config set.....	179
11.3.6	Edit exported configurations.....	180
11.3.7	Set lab to boot from config set.....	181
11.3.8	Set lab to boot from none.....	181
11.3.9	Delete a config set.....	182
11.3.10	Rename a config set.....	182
11.3.11	Export a config set to your local PC.....	182
11.3.12	Import config set from local PC.....	182
11.3.13	Export a single nodes config to your local PC.....	183
11.3.14	Import a single nodes config from your local PC.....	183
11.3.15	Set lab nodes to boot from different config sets.....	183
11.3.16	Lab config script timeout.....	184
11.4	LAB TIMER.....	184
11.4.1	Set the Lab Countdown Timer.....	184
11.4.2	Stop the Lab Countdown Timer.....	185
11.5	LAB TASKS.....	185
11.5.1	Creating a new simple task.....	185
11.5.2	Edit a simple task.....	185
11.5.3	Create a multi tabs task (task on multiple tabs/pages).....	186
11.5.4	Edit a multi tabs task (task on multiple tabs/pages).....	186
11.5.5	Edit tabs (Multi tabbed task).....	187
11.5.6	Create a task with your PDF workbook.....	188
11.5.7	Create a task with Online document (PDF or HTML).....	190
11.5.8	Delete a task.....	191
12	WIRESHARK CAPTURE	192
12.1	NATIVE CONSOLE WIRESHARK CAPTURING	192
12.2	HTML5 CONSOLE WIRESHARK CAPTURING	193
12.3	HTML5 DESKTOP CONSOLE WIRESHARK CAPTURING	196

13	THINCLIENT FILE EXCHANGE	198
13.1	THINCLIENT FILES DOWNLOADING	198
13.2	THINCLIENT FILE UPLOAD	199
13.3	OTHER THINCLIENT FILE OPERATIONS	201
14	DOCKERS	204
14.1	EVE INTEGRATED DOCKER STATIONS.....	204
14.1.1	<i>Docker Machines</i>	<i>204</i>
14.1.2	<i>Docker DHCP IP address setup</i>	<i>206</i>
14.1.3	<i>Docker Static IP and MAC address setup</i>	<i>207</i>
14.1.4	<i>Docker multi interfaces setup</i>	<i>208</i>
14.1.5	<i>Docker server-gui custom WEB page.....</i>	<i>209</i>
14.1.6	<i>Docker server-gui SSL WEB page</i>	<i>211</i>
14.2	DOCKER CONSOLES	212
14.3	DOCKER CLI ROOT ACCESS.....	212
14.4	DOCKERS RE-INSTALL/UPDATE	213
14.5	EXTRA DOCKER PACKAGES.....	213
14.6	THIRD PARTIES DOCKERS	214
14.6.1	<i>Simple docker installation</i>	<i>214</i>
14.6.2	<i>Docker stack installation</i>	<i>215</i>
14.7	CUSTOMIZE DOCKER IMAGE WITH YOUR OWN CHANGES.	217
14.8	DELETE DOCKER IMAGE FROM EVE	218
15	EVE CLUSTER SYSTEM.....	220
15.1	EVE CLUSTER DESIGN MODELS.....	220
15.1.1	<i>Bare metal servers cluster</i>	<i>220</i>
15.1.2	<i>ESXi Virtual Machines cluster.....</i>	<i>220</i>
15.1.3	<i>Hybrid cluster</i>	<i>221</i>
15.1.4	<i>VM Ware workstation light cluster</i>	<i>221</i>
15.1.5	<i>Google Cloud cluster</i>	<i>221</i>
15.2	EVE CLUSTER PRE-REQUISITES	222
15.2.1	<i>Firewall rules between Master and Satellite nodes</i>	<i>222</i>
15.2.2	<i>EVE Cluster internal management network.....</i>	<i>222</i>
15.2.3	<i>EVE Cluster Member's hardware requirements</i>	<i>222</i>
15.2.4	<i>NTP Synchronization requirements</i>	<i>222</i>
15.3	EVE CLUSTER MASTER NODE INSTALLATION	222
15.4	ESXI EVE SATELLITE VM INSTALLATION	223
15.4.1	<i>EVE-NG Satellite ESXi VM Setup and Settings</i>	<i>223</i>
15.4.2	<i>EVE-NG Satellite ESXi VM Installation steps.....</i>	<i>225</i>
15.5	BARE METAL SERVER EVE SATELLITE INSTALLATION	229
15.5.1	<i>Ubuntu Server Installation Phase 1</i>	<i>229</i>
15.6	GOOGLE CLOUD EVE SATELLITE INSTALLATION	234
15.6.1	<i>Preparing Ubuntu boot disk template</i>	<i>234</i>
15.6.2	<i>Creating VM.....</i>	<i>235</i>
15.6.3	<i>EVE GCP Satellite installation</i>	<i>237</i>
15.6.4	<i>GCP Firewall rules for Cluster</i>	<i>239</i>
15.7	CLUSTER MANAGEMENT.....	240
15.7.1	<i>Join Satellite nodes to the Master.....</i>	<i>240</i>
15.7.2	<i>Remove Satellite nodes from the Master.....</i>	<i>241</i>
15.7.3	<i>Re-join Satellite nodes from the Master.....</i>	<i>241</i>
15.8	CLUSTER ASSIGNMENT HIERARCHY	241
15.8.1	<i>User assignment to the dedicated Satellite (Option 1)</i>	<i>242</i>
15.8.2	<i>Lab assignment to dedicated cluster Satellite (Option 2)</i>	<i>243</i>
15.8.3	<i>Creating EVE labs in Cluster (Option 3)</i>	<i>244</i>
15.8.4	<i>Master images synchronization with Satellites</i>	<i>244</i>
15.9	CLUSTER SYSTEM MONITORING	245
15.9.1	<i>Cluster Monitoring page.....</i>	<i>245</i>
15.9.2	<i>Satellite disaster recovery.....</i>	<i>245</i>

15.9.3	<i>EVE Cluster Status</i>	246
15.9.4	<i>Cluster monitoring cli commands</i>	246
15.10	CLUSTER SYSTEM UPGRADE	247
16	EVE TROUBLESHOOTING	249
16.1	CLI DIAGNOSTIC INFORMATION DISPLAY COMMANDS	249
16.1.1	<i>Display full EVE Pro diagnostic</i>	249
16.1.2	<i>Display the currently installed EVE Pro version:</i>	249
16.1.3	<i>Display if EVEs Intel VT-x/EPT option on/off:</i>	249
16.1.4	<i>Display EVEs CPU INFO:</i>	249
16.1.5	<i>Display EVEs CPU manufacturer:</i>	249
16.1.6	<i>Display EVEs HDD utilization.</i>	250
16.1.7	<i>Display EVEs Bridge interface status</i>	250
16.1.8	<i>Display EVEs system services status</i>	250
16.2	EXPAND EVEs SYSTEM HDD.....	250
16.2.1	<i>HDD space alert</i>	251
16.2.2	<i>Expand HDD on VMware Workstation</i>	251
16.2.3	<i>Expand your HDD on ESXi</i>	252
16.2.4	<i>Expand your HDD on a Bare Metal EVE Server</i>	252
16.3	RESET MANAGEMENT IP	252
16.4	EVE PRO SQL DATABASE RECOVERY	252
16.5	EVE PRO MIGRATION FROM HOST TO HOST	253
16.6	EVE LOG FILES	253
16.7	EVE CLI DIAGNOSTIC INFO.....	253
17	EVE EXTRAS	255
17.1	EVE PRO RADIUS SERVER SETUP FOR USER AUTHENTICATION	255
17.1.1	<i>EVE User setup for Radius authentication</i>	255
17.2	ACTIVE DIRECTORY USER AUTHENTICATION	256
17.2.1	<i>EVE User setup for AD (LDAP) authentication</i>	257
17.3	LAB CHAT.....	258
17.4	CUSTOM MAC ADDRESS FOR NODE MANAGEMENT	258
17.5	WINDOWS NODE SETTINGS FOR WIFI DONGLE	259
18	IMAGES FOR EVE	262
18.1	QEMU IMAGE NAMING TABLE	262
18.2	HOW TO PREPARE IMAGES FOR EVE.....	263
18.3	HOW TO ADD CUSTOM IMAGE TEMPLATE.....	263
18.3.1	<i>Templates folder choice</i>	263
18.3.2	<i>Prepare template file</i>	263
18.3.3	<i>Prepare interface format and name lines</i>	264
18.3.4	<i>Edit your new template file:</i>	266
18.3.5	<i>Prepare new icon for your template:</i>	267
18.3.6	<i>Template use</i>	267
18.4	HOW TO HIDE UNUSED IMAGES IN THE NODE LIST	267
19	EVE RESOURCES	268

Preface

When I first heard about EVE-NG I was skeptical. Back then I used to Lab mainly with ESX by deploying many virtual Devices and connecting them manually by separate vSwitches for Point-to-Point connections. The Problem with that was, that it was extremely time-consuming and did not scale - for every new Device I had to create multiple vSwitches to interconnect them with the virtual Machines - a Nightmare. I was in the middle of my JNCIE-Exam-Prep when I first saw EVE-NG on Twitter - I downloaded the Community Edition, which was the only Edition back then and I was amazed how easy Labbing all of a sudden was. No more deploying of vSwitches to interconnect nodes and boy did it Scale...

If you follow me on Twitter you know, that I'm one of the hardest Juniper Fanboys and of course my Goal was to "Juniperize" EVE. I started to get in touch with UD and Alain and found myself into the Position as one of the Juniper Test Guys. Meanwhile I added nearly all Juniper related Devices (including vSRX and JATP) and I still test a Lot - but now on EVE-Pro.

The Pro-Edition was a big step forward for the Project. It added some nice Features like "hot-add-interconnect" and the Ability to use EVE-NG with multiple Users. Especially Companies will love EVE as it is THE Solution for Labs and PoC's. I have successfully run over 30 PoC's in EVE and over 100 Labs (Job-Related and Personal Labs) - and I still enjoy it every day thanks to EVE and the amazing Team behind it. When the Guys asked me to write the Introduction I was of course honored and now this Book is finally coming out to help you on your Quest to Setup, Run and Manage EVE-NG in a lot of possible ways.

Well - enough from my Side. I hope you enjoy this Cookbook and use it wisely for your Everyday EVE Work. If you have Problems there is always the EVE-Forum and Live-Helpdesk - you will also find me there from time to time ;)

I wish you happy reading and if you think, that this Product is amazing feel free to support it by buying the PRO-Edition or Donating a bit – it helps to expand this already cool Product even more and it also honors all the work that the Guys spent in it.

Christian Scholz
@chsjuniper

1 Introduction

1.1 What is EVE-NG?

To describe what **Emulated Virtual Environment – Next Generation** (EVE-NG) is without solely stating dry facts about features, we need to elaborate more on what EVE-NG can be used for and whom it would be useful for.

In some trivial dry words, EVE-NG gives you tools to use around virtual devices and interconnect them with other virtual or physical devices. Many of its features greatly simplify the usability, re-usability, manageability, interconnectivity, distribution and therefore the ability to understand and share topologies, work, ideas, concepts or simply “labs”. This can simply mean it will reduce the cost and time to set up what you need or it might enable you to do tasks you would not have thought could be done this simple.

1.2 What is EVE-NG used for?

This is the real question but there is no finite answer, the possibilities are almost limitless and depends on what you want to use it for.

It can be used for studying all kinds of technologies. You can learn about general technologies or vendor specific topics. You can test new technologies like network automation, SDN, etc.

It can be used to recreate corporate networks and test changes before putting them into production. You can create proof of concepts for clients. You can troubleshoot network issues by recreating them and e.g. use Wireshark to inspect packets.

It is most definitely not just for networking, it can be used to test software in simulated networks, test out security vulnerabilities of any kind, system engineering like LDAP and AD servers and many more areas.

You could set it up to automate sandboxing unknown files/software and use software to analyse short and long term behaviour for malicious intent much simpler than without EVE-NG.

The list of what EVE-NG can be used for could go on indefinitely, possibilities are limited by knowledge and imagination only. Both of which can be improved with EVE-NG.

To get a very small idea of what can be done with EVE-NG, check out the tested/[supported images](#) (many have not been tested, almost everything virtual should run on EVE-NG) and refer to section [17](#).

EVE-NG helps you achieve what you want to and more.

1.3 Who is EVE-NG for?

EVE-NG is for everyone working in the Information Technology Sector, period.

It is for very large enterprise companies, training facilities, service providers, consultants, people who want to train themselves; it is for everyone, it is for YOU!

Use-cases that are more than worth it, almost priceless even, can be found everywhere.

The EVE-NG community version is free for everyone; while the paid professional version adds a few things that make your life easier. Almost everything can still be done with the free version, just less conveniently and therefore more time-consuming.

However, with the free version, the possibility to train yourself with technologies, hone your skills and become an expert even with very no monetary possibilities. For some this is and has been life changing.

2 System requirements

EVE-NG is available in the OVF or ISO file format. The Open Virtualization Format (OVF) is an open standard for packaging and distributing virtual appliances. It can be used to deploy a VM in hypervisors like VMware Workstation, Player and ESXi. Please note that installing EVE as a Virtual Machine (VM) will mean any nodes deployed within EVE will be nested. Nested virtualization causes degraded performance in deployed nodes. This should be fine for lab purposes as long as the host meets or exceeds the resource requirements for the deployed nodes.

EVE-NG can also be installed directly on physical hardware, without a hypervisor, using the provided ISO image. This is referred to as a “bare metal” install and is the most recommended method of installing EVE-NG.

2.1 Hardware requirements

2.1.1 Minimal Laptop/PC Desktop system requirements

Prerequisites:

- CPU: Intel CPU supporting Intel® VT-x /EPT virtualization
- Operating System: Windows 10, 11 or Linux Desktop
- VMware Workstation 15.0 or later
- VMware Player 15.0 or later

PC/Laptop HW requirements	
CPU	Intel i7 (4 Logical processors), Enabled Intel virtualization in BIOS
RAM	8Gb
HDD Space	50Gb
Network	LAN/WLAN
EVE Virtual machine requirements	
CPU	4/1 (Amount of processors/Number of cores per processor) Enabled Intel VT-x/EPT virtualization engine
RAM	6Gb or more
HDD	50Gb or more
Network	VMware NAT or Bridged network adapter

Note: Minimal PC Desktop/Laptop will be able to run small Labs. The performance and quantity of nodes per lab depend on the types of nodes deployed in the lab.

Example:

- IOL image-based nodes: up to 40-50 nodes per lab
- Dynamips image-based nodes: up to 20-25 nodes per lab
- vIOS image-based nodes: up to 8-10 nodes per lab
- CSRv1000 or XRv image-based nodes: up to 2-3 per lab

2.1.2 Recommended Laptop/PC Desktop system requirements

Prerequisites:

CPU: Intel CPU supporting Intel® VT-x /EPT virtualization
 Operation System: Windows 10, 11 or Linux Desktop
 VMware Workstation 15.0 or later
 VW Ware Player 15.0 or later

PC/Laptop HW requirements	
CPU	Intel i7 (16 Logical processors), Enabled Intel virtualization in BIOS
RAM	32Gb
HDD Space	200Gb
Network	LAN/WLAN
EVE Virtual machine requirements	
CPU	16/1 (Amount of processors/Number of cores per processor) Enabled Intel VT-x/EPT virtualization engine
RAM	24Gb or more
HDD	200Gb or more
Network	VMware NAT or Bridged network adapter

Note: PC Desktops/Laptops will be able to run small to medium Labs. Performance and quantity of nodes per lab depend on the type of nodes deployed in the lab.

Example:

IOL image-based nodes: up to 120 nodes per lab
 vIOS image-based nodes: up to 20-40 nodes per lab
 CSR image-based nodes: up to 10 per lab

2.1.3 Virtual Server system requirements

Prerequisites:

CPU: Intel Xeon CPU supporting Intel® VT-x with Extended Page Tables (EPT)
 Operation System: ESXi 6.0 or later

Server HW requirements	
CPU	Recommended CPU 2x Intel E5-2650v4 (48 Logical processors) or better supporting Intel® VT-x with Extended Page Tables (EPT) Minimum CPU is any Intel Xeon CPU supporting Intel® VT-x with Extended Page Tables (EPT)
RAM	128Gb
HDD Space	2Tb
Network	LAN Ethernet
EVE Virtual machine requirements	
CPU	48/1 (Amount of processors/Number of cores per processor) Enabled Intel VT-x/EPT virtualization engine
RAM	64Gb or more
HDD	800Gb or more

Network	vSwitch/VMnet
---------	---------------

Note: Performance and quantity of nodes per lab depends from the type of nodes used in the lab.

Example:
120 IOL image-based lab
20 CSRV1000 image-based nodes per lab

2.1.4 Dedicated Server (bare metal BM) system requirements

Prerequisites:

CPU: Intel Xeon CPU supporting Intel® VT-x with Extended Page Tables (EPT)
Operation System: Ubuntu Server 20.04 LTS x64

Server HW requirements	
CPU	Recommended CPU Intel E5-2650v4 (48 Logical processors) or better supporting Intel® VT-x with Extended Page Tables (EPT) Minimum CPU is any Intel Xeon CPU supporting Intel® VT-x with Extended Page Tables (EPT)
RAM	128Gb
HDD Space	2Tb
Network	LAN Ethernet

Note: Performance and quantity of nodes per lab depends from type of nodes used in the lab.

2.1.5 Nodes per lab calculator

It is recommended to use the “nodes per lab calculator” to achieve best performance and avoid overloading your EVE system.

2.1.6 Hardcoded Subnets in the EVE

NOTE: Please make sure if these subnets are NOT used in your network outside of EVE.

- 172.29.129.0/24 (NAT Interface)
- 172.29.130.0/24 (Cluster subnet)
- 172.17.0.0/16 (Dockers consoles)

These networks CAN NOT be changed, because are involved in many EVE code processes.

2.2 Supported virtualization platforms and software

- VMware Workstation 15.0 or later
- VMware Player 15.0 or later
- VMware ESXi 6.0 or later
- Ubuntu Server 20.04 LTS as platform for bare metal

- Google Cloud Platform
- AMD CPU based PC or Server (the Newest AMD CPU versions are supported)

2.3 Unsupported hardware and systems

The following are currently not supported officially:

- VirtualBox virtualization
- Citrix XenServer
- Microsoft HyperV
- Proxmox
- MAC OSX M1 CPU

3 Installation

3.1 VMware Workstation or VM Player

3.1.1 VMware workstation EVE VM installation using ISO image (preferred)

⚠ Mandatory Prerequisites: Internet must be reachable from your PC and VMware. EVE ISO installation requires internet access to get updates and install the latest EVE-PRO version from the EVE-NG repository. DNS must work as well, to check it, do a named ping, for example ping www.google.com

Download EVE-NG Professional ISO distribution image:

<https://www.eve-ng.net/index.php/download/>

3.1.1.1 EVE VM Setup and Settings

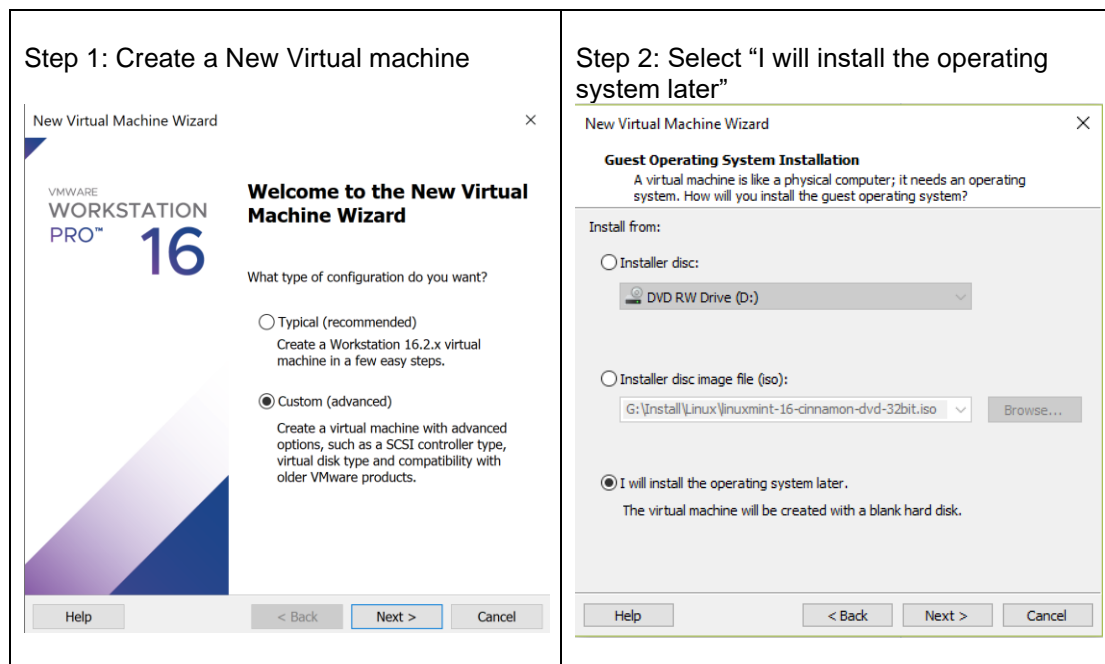

Step 3: Select a Guest Operating system: Linux and select the version: Ubuntu 64-bit

Step 4: Enter the name for your EVE-PRO VM and select Location where your EVE VM will be stored on the host PC.

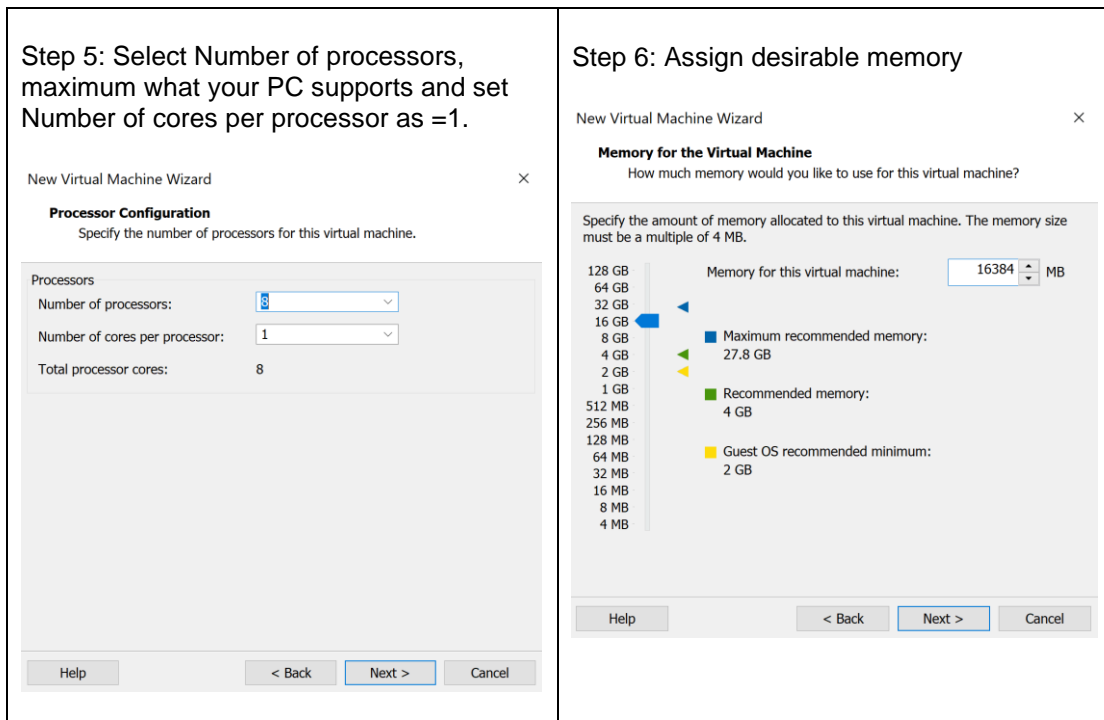
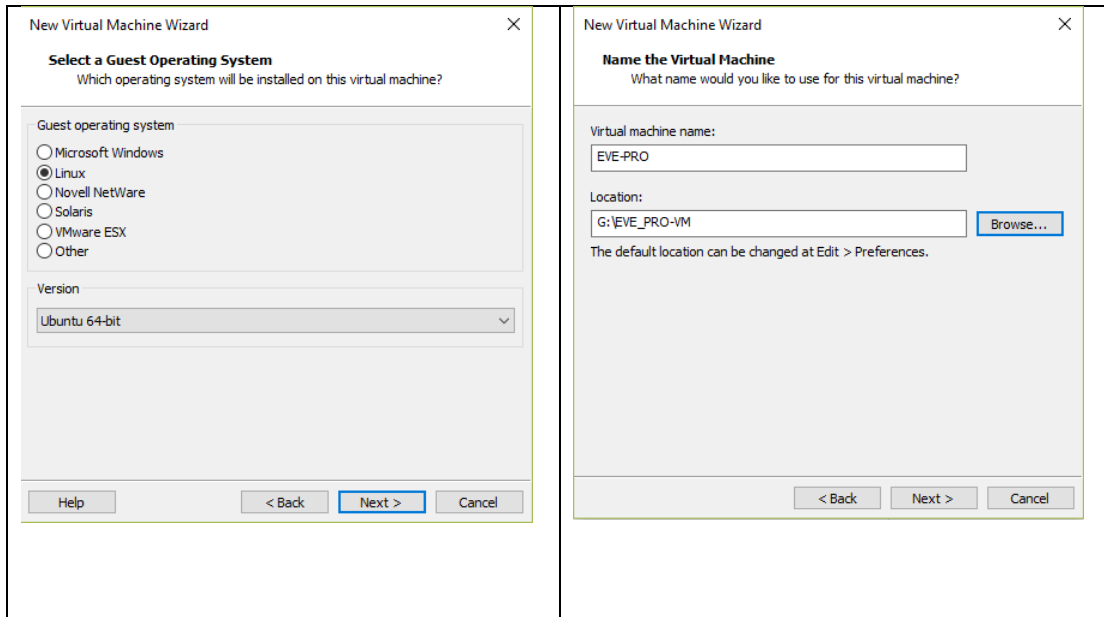

<p>Step 7a: Select your desirable Network Adapter. Laptop PC</p> <p>NOTE: It is recommended to choose the NAT adapter option for Laptops to avoid EVE management interface IP changes. This can happen anytime the laptop is</p>	<p>Step 7b: Select your desirable Network Adapter. Desktop PC</p> <p>NOTE: Desktop PC EVE management interface can be either NAT or Bridged to</p>
---	---

<p>connected to a different SSID.</p> <p>New Virtual Machine Wizard</p> <p>Network Type What type of network do you want to add?</p> <p>Network connection</p> <ul style="list-style-type: none"> <input type="radio"/> Use bridged networking Give the guest operating system direct access to an external Ethernet network. The guest must have its own IP address on the external network. <input checked="" type="radio"/> Use network address translation (NAT) Give the guest operating system access to the host computer's dial-up or external Ethernet network connection using the host's IP address. <input type="radio"/> Use host-only networking Connect the guest operating system to a private virtual network on the host computer. <input type="radio"/> Do not use a network connection <p>Help < Back Next > Cancel</p>	<p>home LAN subnet.</p> <p>New Virtual Machine Wizard</p> <p>Network Type What type of network do you want to add?</p> <p>Network connection</p> <ul style="list-style-type: none"> <input checked="" type="radio"/> Use bridged networking Give the guest operating system direct access to an external Ethernet network. The guest must have its own IP address on the external network. <input type="radio"/> Use network address translation (NAT) Give the guest operating system access to the host computer's dial-up or external Ethernet network connection using the host's IP address. <input type="radio"/> Use host-only networking Connect the guest operating system to a private virtual network on the host computer. <input type="radio"/> Do not use a network connection <p>Help < Back Next > Cancel</p>
--	--

<p>Step 8: Leave I/O controller Type as recommended (LSI Logic).</p> <p>New Virtual Machine Wizard</p> <p>Select I/O Controller Types Which SCSI controller type would you like to use for SCSI virtual disks?</p> <p>I/O controller types</p> <p>SCSI Controller:</p> <ul style="list-style-type: none"> <input type="radio"/> BusLogic (Not available for 64-bit guests) <input checked="" type="radio"/> LSI Logic (Recommended) <input type="radio"/> LSI Logic SAS <input type="radio"/> Paravirtualized SCSI <p>Help < Back Next > Cancel</p>	<p>Step 9: Leave recommended Disk Type: SCSI</p> <p>New Virtual Machine Wizard</p> <p>Select a Disk Type What kind of disk do you want to create?</p> <p>Virtual disk type</p> <ul style="list-style-type: none"> <input type="radio"/> IDE <input checked="" type="radio"/> SCSI (Recommended) <input type="radio"/> SATA <input type="radio"/> NVMe <p>Help < Back Next > Cancel</p>
--	---

Step 10: Select "Create a new virtual disk".

New Virtual Machine Wizard

Select a Disk
Which disk do you want to use?

Disk

Create a new virtual disk
A virtual disk is composed of one or more files on the host file system, which will appear as a single hard disk to the guest operating system. Virtual disks can easily be copied or moved on the same host or between hosts.

Use an existing virtual disk
Choose this option to reuse a previously configured disk.

Use a physical disk (for advanced users)
Choose this option to give the virtual machine direct access to a local hard disk. Requires administrator privileges.

Help < Back Next > Cancel

Step 11: Type your **desirable** HDD size and select "Store virtual disk as single file". It is recommended to set not less than 200GB HDD. Click Next 2 times.

New Virtual Machine Wizard

Specify Disk Capacity
How large do you want this disk to be?

Maximum disk size (GB): 200

Recommended size for Ubuntu 64-bit: 20 GB

Allocate all disk space now.
Allocating the full capacity can enhance performance but requires all of the physical disk space to be available right now. If you do not allocate all the space now, the virtual disk starts small and grows as you add data to it.

Store virtual disk as a single file

Split virtual disk into multiple files
Splitting the disk makes it easier to move the virtual machine to another computer but may reduce performance with very large disks.

Help < Back Next > Cancel

Step 12: Press Customize Hardware

New Virtual Machine Wizard

Ready to Create Virtual Machine
Click Finish to create the virtual machine. Then you can install Ubuntu 64-bit.

The virtual machine will be created with the following settings:

Name: EVE-PRO
Location: D:\EVE-V5-PRO-VM
Version: Workstation 16.2.x
Operating System: Ubuntu 64-bit

Hard Disk: 200 GB
Memory: 16384 MB
Network Adapter: NAT
Other Devices: 8 CPU cores, CD/DVD, USB Controller, Printer, Sound Card

Customize Hardware...

< Back Finish Cancel

Step 13: Assign desirable memory

Hardware

Device	Summary
Memory	1 GB
Processors	1
New CD/DVD (SATA)	Auto detect
Network Adapter	NAT
USB Controller	Present
Sound Card	Auto detect
Printer	Present
Display	Auto detect

Memory

Specify the amount of memory allocated to this virtual machine. The memory size must be a multiple of 4MB.

Memory for this virtual machine: 16384 MB

64 GB
32 GB
16 GB
8 GB
4 GB
2 GB
1 GB
512 MB
256 MB
128 MB
64 MB
32 MB
16 MB
8 MB
4 MB

Maximum recommended memory (Memory swapping may occur beyond this size.) 28.0 GB

Recommended memory 1 GB

Guest OS recommended minimum 512 MB

The virtual machine will use up to 768 MB of this memory for graphics memory. You can change this amount in the Display settings page.

Add... Remove

Close Help

Step 14: **IMPORTANT** Set Processors "Number of processors" and "Number of cores per processor". Set Intel VT-x/EPT Virtualization engine to ON (checked).

Step 15: Select CD/DVD Option: "use ISO image file." Browse to your downloaded EVE-PRO.iso (actual name can be different) file

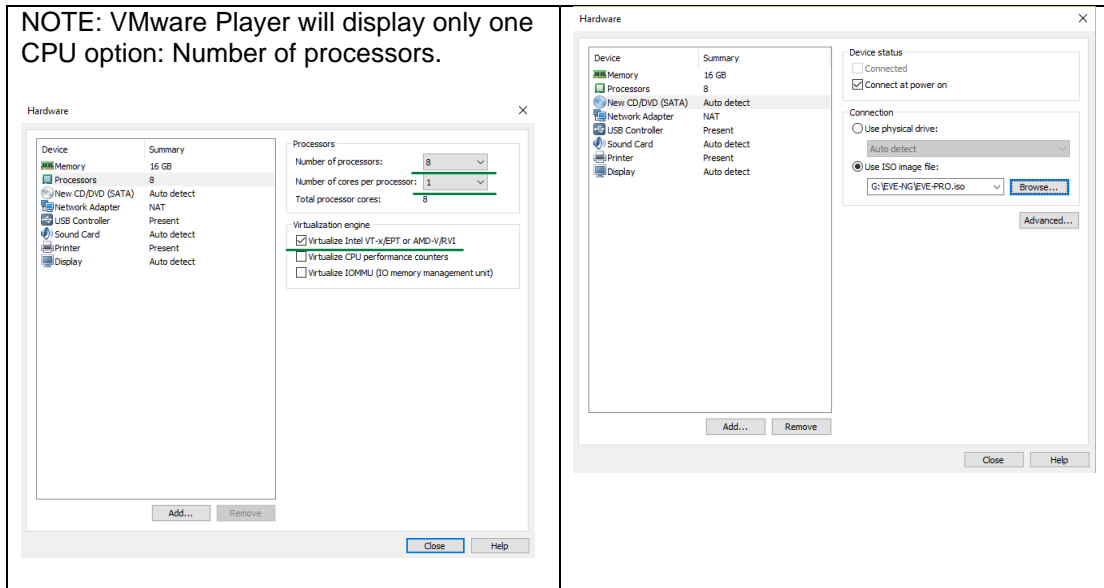

Step 16: Confirm VM Settings.

3.1.1.2 EVE-NG VM Installation steps

! Mandatory Prerequisites: Internet must be reachable from your PC and VMware. EVE ISO installation requires internet access to get updates and install the latest EVE-PRO version from the EVE-NG repository. DNS must work as well, to check it, do a named ping, for example ping www.google.com

EVE VM Installation from ISO has 3 Phases

Phase 1 (Ubuntu installation)

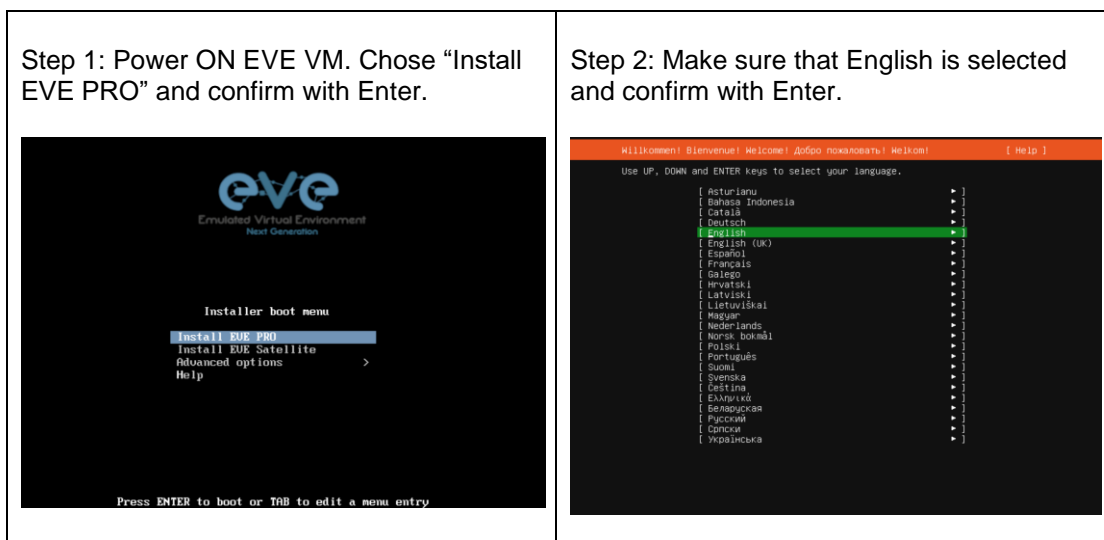

Step 3: Make sure that English US Keyboard is selected and confirm with Enter.

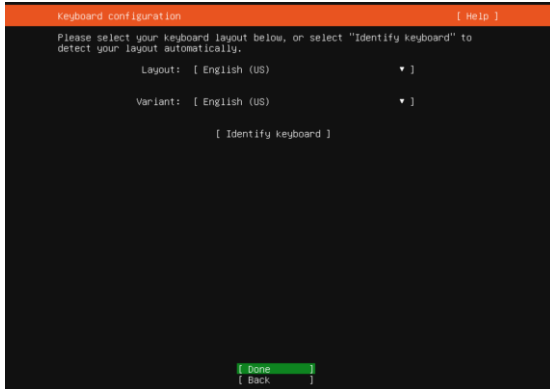

Step 4: If your network has **DHCP ENABLED**, Continue to **Step 10**

Step 5: If your network has not **DHCP**. Static IP setup. If you have not enabled DHCP in the network, you must assign an IP address manually. Use arrow UP key to select your interface for IP address assignment.

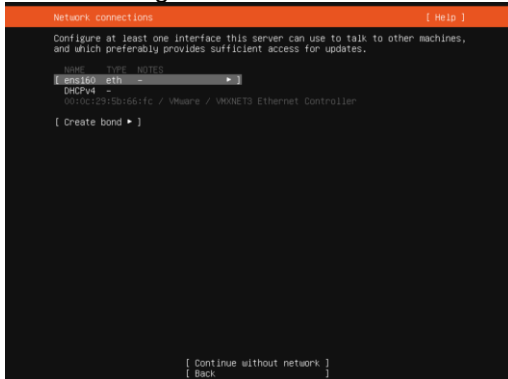

Step 6: Confirm interface selection with Enter, select "Edit IPv4" and confirm with Enter again.

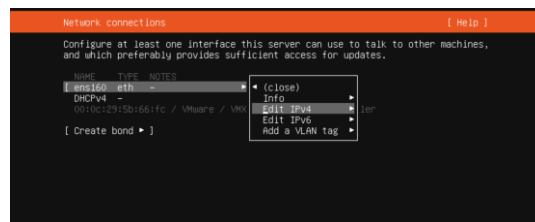

Step 7: Hit Enter on IPv4 Method and select "Manual", confirm with Enter.

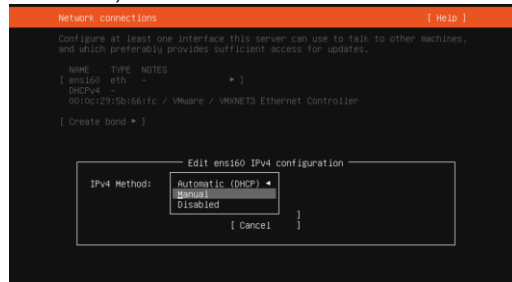

Step 8: Enter your "Subnet", "IP Address", "Gateway IP", "Domain server IPs" and "Search domain". Select "Save" and confirm with Enter. **NOTE, it is very important that your DNS (Name servers) will resolve Internet names.**

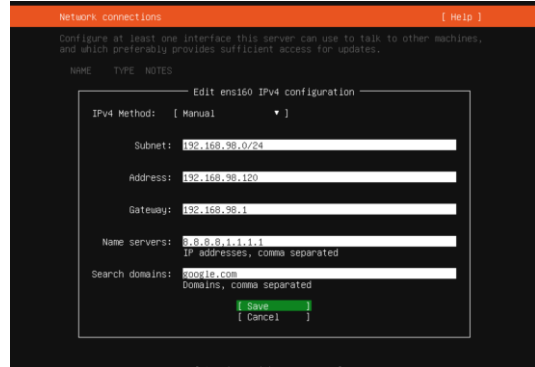

Step 9: Select "Done" and confirm with Enter

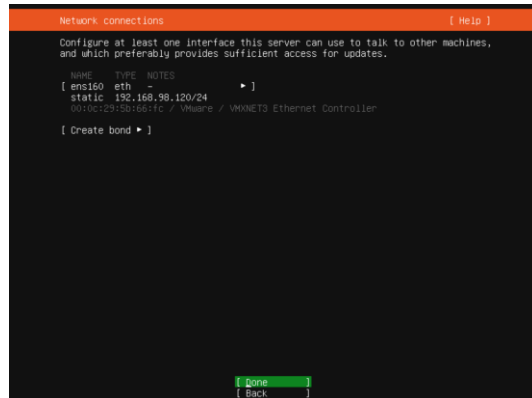

Step 10: Now, when your Static or DHCP IP settings are correct, select Done and confirm with Enter.

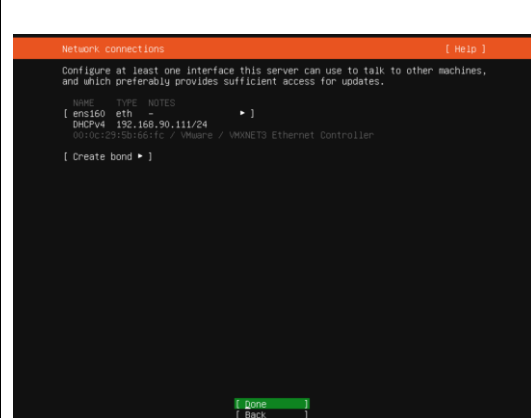

Step 11: If you have proxy in use for your internet, assign your network proxy settings. If no proxy in use, with Tab key select Continue and confirm with Enter.

Step 12: Select "Continue" and confirm with Enter.

--	--

EVE VM Installation Phase 3 (Management IP setup and updates)

<p>Step 17: Setup EVEs Management IP address. A Static IP address setup is preferred.</p> <p>Follow steps in section: 3.5.1 for static IP, 3.5.2 for DHCP IP</p>	<p>Step 18: After your EVE is rebooted, Login to EVE CLI and type:</p> <pre>apt update apt upgrade</pre> <p>If required, follow steps in section: 5.1, 5.2</p>
--	---

NOTE: Verify your EVE-NG server installation, type “dpkg -l eve-ng-pro” command, it must display latest EVE Pro version

```
root@eve-ng:~# dpkg -l eve-ng-pro
Desired=Unknown/Install/Remove/Purge/Hold
| Status=Not/Inst/Conf-files/Unpacked/halF-conf/Half-inst/trig-aWait/Trig-pend
|/ Err?=(none)/Reinst-required (Status,Err: uppercase=bad)
||/ Name Version Architecture Description
+++-----
=====
ii eve-ng-pro 5.0.1-7 amd64 A new generation software
for networking labs.
root@eve-ng:~#
```

NOTE: If your newly installed EVE-PRO shows nothing like above, you must check your internet reachability and verify DNS configuration on your EVE-PRO server.

```
root@eve-ng:~# ping www.google.com
PING www.google.com (172.217.22.164) 56(84) bytes of data.
64 bytes from arn09s11-in-f164.1e100.net (172.217.22.164): icmp_seq=1
ttl=120 time=8.84 ms
64 bytes from arn09s11-in-f164.1e100.net (172.217.22.164): icmp_seq=2
ttl=120 time=8.84 ms
^C
--- www.google.com ping statistics ---
2 packets transmitted, 2 received, 0% packet loss, time 1001ms
rtt min/avg/max/mdev = 8.848/8.848/8.849/0.094 ms
root@eve-ng
```

Launch EVE-PRO installation manually

```
root@eve-ng:~# cd /etc
root@eve-ng:~# ./eve-setup
```

<p>Step 19: After update, and Step 18 is completed, continue with type:</p> <pre>apt update apt install eve-ng-dockers</pre>	<p>Step 20: (Optional) If after dockers first install (Step 19) in the output “dc images” you still seeing some docker name in the list as <none>.</p> <pre>root@eve-ng:~# dc images REPOSITORY TAG IMAGE ID CREATED SIZE docker none cc286e6ac274 16 seconds ago 1.87GB eve-dns-server latest 52a6609a256 3 minutes ago 1.04GB eve-wireshark latest 638ed7c15b80 12 minutes ago 987MB eve-iptables latest 55939d72807 13 minutes ago 1.45GB eve-ovs210 latest 786c2d618a5 15 minutes ago 2.75GB</pre>
--	--

This can take some time depending on your Internet connection and disk speed.

Your output after install must look like:

```
root@eve-ng:~# dc images
REPOSITORY      ID          IMAGE ID      CREATED      SIZE
eve-desktop     latest     ca1333621b47  12 hours ago 3.65GB
eve-gui-server  latest     9db19c879a17  2 days ago   3.84GB
eve-firefox     latest     0266410ba1bb  7 weeks ago  2.12GB
eve-nginx32     latest     92a109779e99  7 weeks ago  1.56GB
root@eve-ng:~#
```

please run the command:

```
apt install --reinstall eve-ng-dockers
```

You must get output like in the step 19.

Step 21: Proceed to section 4 “Obtain EVE-NG Professional license”

⚠ IMPORTANT NOTE: You must prepare and upload at least a couple of images to start building your labs. Refer to section 17

3.1.2 VMware workstation OVF deployment

Download EVE-NG Professional OVF image zip file, place it in the dedicated HDD storage for EVE VM and unzip it:

<https://www.eve-ng.net/index.php/download/>

3.1.2.1 Deployment and VM machine settings

Step 1: VMware workstation or VM Player, Open Virtual Machine

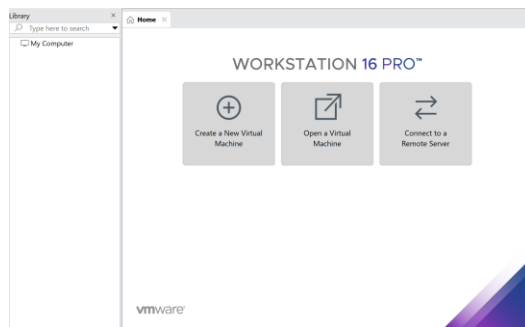

Step 2: Browse your downloaded and unzipped EVE-PRO-5, EVE-PRO-5.ovf, followed by Open

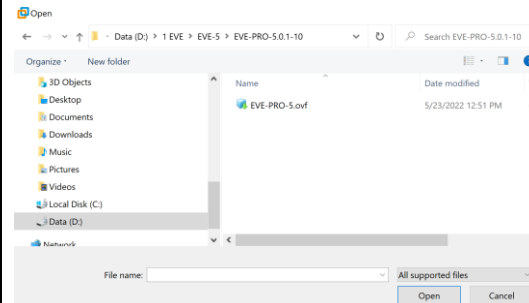

Step 3: Give VM name (Example: EVE-PRO) and browse your desired EVE VM store destination followed by Import

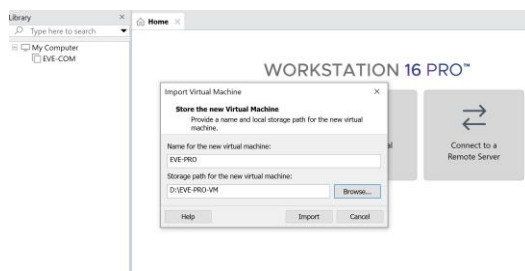

Step 4: Open your EVE VM Settings and set the desired RAM.

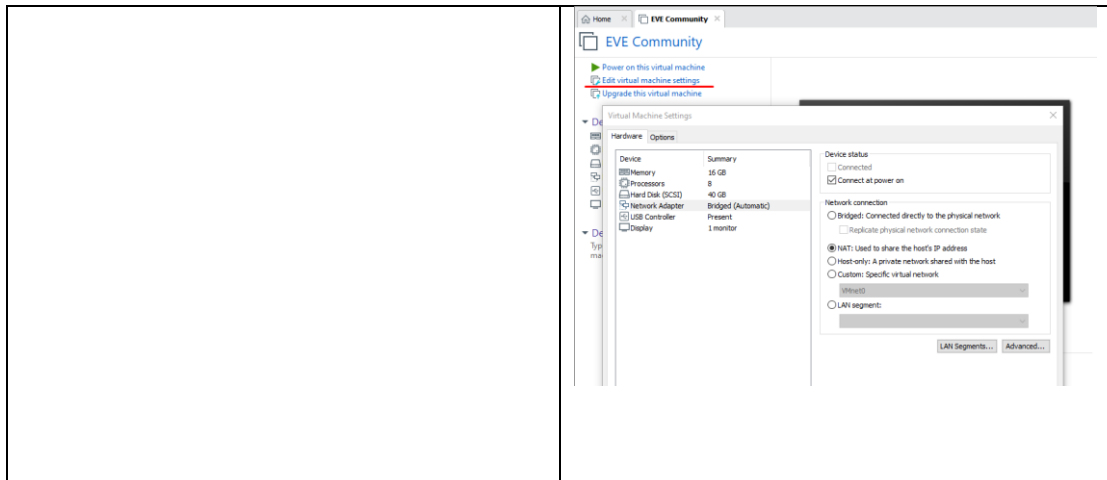

Step 5: **IMPORTANT** Set CPU Number of Cores and number of cores per processor. Set Intel VT-x/EPT Virtualization engine to ON (checked).

NOTE: VMware Player will display only one CPU option: Number of processors.

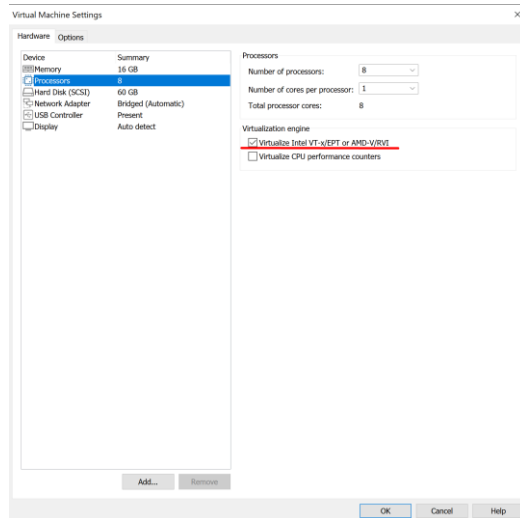

Step 6: **Laptop PC** Select your desirable Network Adapter.

NOTE: It is recommended to choose the NAT adapter option for Laptops to avoid EVE management interface IP changes. This can happen anytime the laptop is connected to a different SSID.

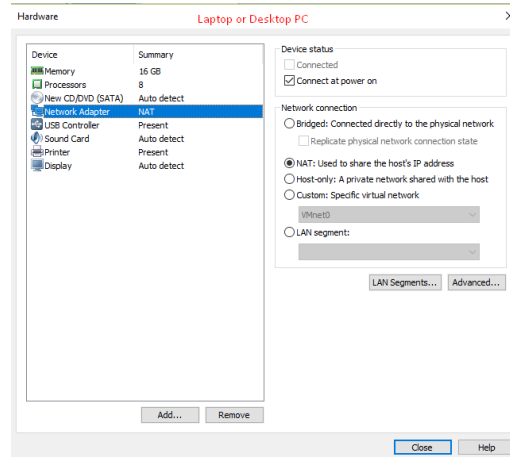

Step 7: **Desktop PC** Select your desirable Network Adapter.

NOTE: Desktop PC EVE management interface can be either NAT or Bridged to home LAN subnet.

Step 8: Power ON your EVE VM and follow Management IP setup instructions described in section 3.5.1 for Static IP or 3.5.2 for DHCP IP.

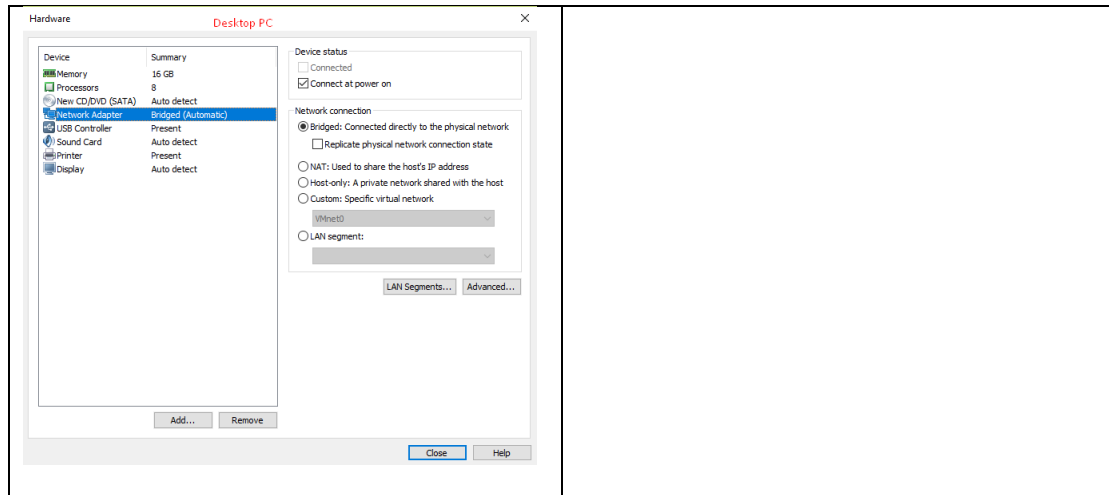

Step 9: Proceed to section 4 “Obtain EVE-NG Professional license”

⚠ IMPORTANT NOTE: You must prepare and upload at least a couple of images to start building your labs. Refer to section 17

3.1.2.2 OVF VM update to the latest EVE version

Step 9: Make sure if your EVE OVF VM is up to date to the newest EVE version. Follow the steps described in section 5.

3.1.2.3 OVF VM HDD Size expansion

⚠ IMPORTANT NOTE: **DO NOT expand** the current EVE OVF HDD. To expand your EVE system size, please follow Troubleshooting section 16.2

3.2 VMware ESXi

3.2.1 VMware ESXi EVE installation using ISO image (preferred)

⚠ Mandatory Prerequisites: Internet must be reachable from your Server and ESXi. EVE ISO installation requires internet access to get updates and install the latest EVE-PRO version from the EVE-NG repository. DNS must work as well, to check it, do a named ping, for example ping www.google.com

⚠ IMPORTANT NOTE: Make sure that you have set Security Policy (Promiscuous mode, forged transmits and MAC changes) settings on the vSwitch and Port group to Accept.

⚠ IMPORTANT NOTE: Do not use NIC teaming for connection to the physical device. Reference: <https://kb.vmware.com/s/article/1004109>

Download EVE-NG Professional ISO distribution image:
<https://www.eve-ng.net/index.php/download/>

3.2.1.1 EVE-NG ESXi VM Setup and Settings

Step 1: Upload EVE ISO image to the ESXi store.

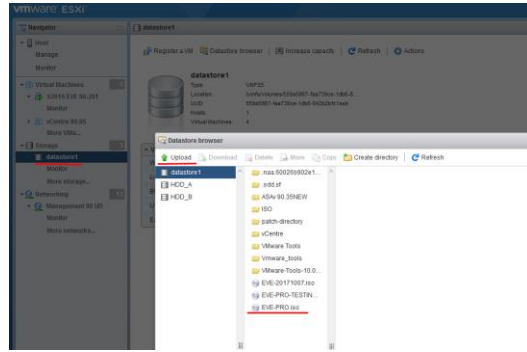

Step 2: Create NEW VM

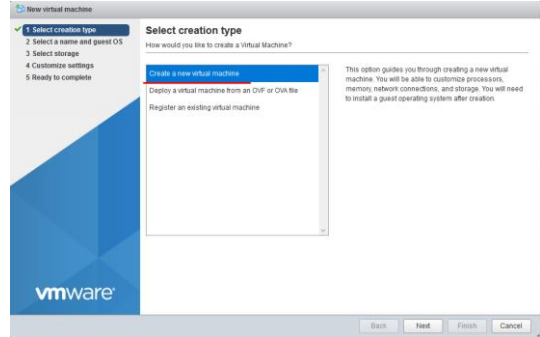

Step 3: Enter the name for your EVE-PRO VM and select Guest Operating system Linux and version: Ubuntu 64-bit

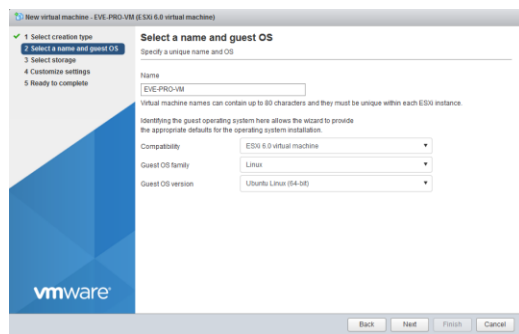

Step 4: Select Location where your EVE VM will be stored in HDD.

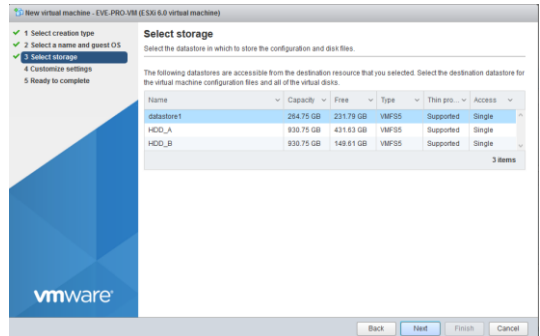

Step 5: IMPORTANT Customize your EVE VM CPU Settings. Set CPU Number of Cores and number of cores per processor. Set Intel VT-x/EPT Virtualization to ON (checked).

Step 6: Assign desirable RAM for your EVE

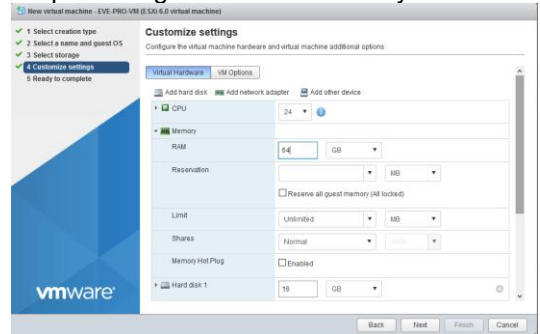

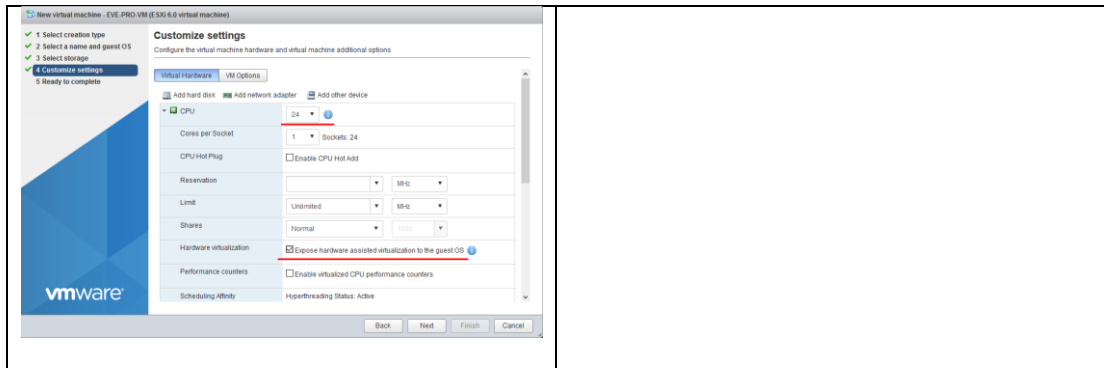

Step 7: Set the size of HDD for your new EVE VM. It is recommended to set "Thick Provisioned eagerly provisioned". Server EVE HDD is recommended to set at least 500Gb

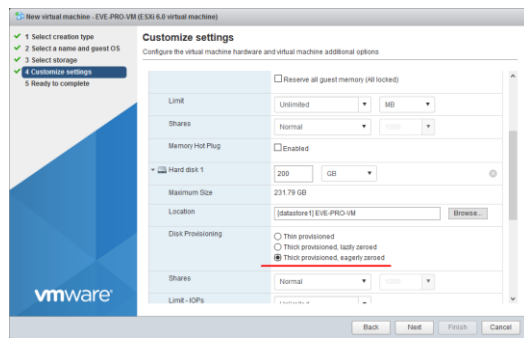

Step 8: Set your Management network. Adapter type VMXNET3

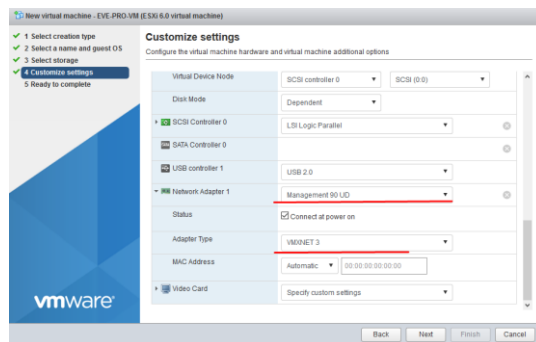

NOTE: Additional Network Adapters can be added for further use.

Step 9: Add new device to your EVE VM, CD/DVD

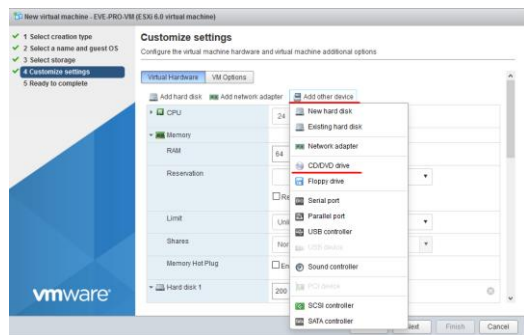

Step 10: Set DVD drive to "Datastore ISO File" and browse your uploaded EVE-PRO.iso. Make sure that Status is checked ON, "Connect at power on"

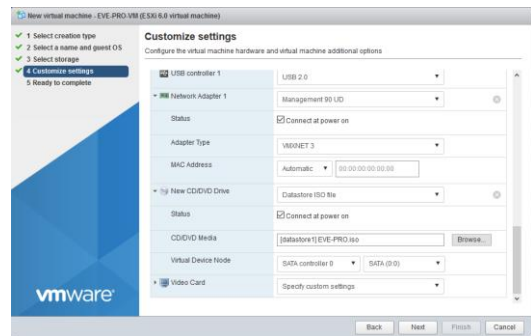

3.2.1.2 EVE-NG ESXi VM Installation steps

- ⚠ **Mandatory Prerequisites:** Internet must be reachable from your PC and VMware. EVE ISO installation requires internet access to get updates and install the latest EVE-PRO version from the EVE-NG repository. DNS must work as well, to check it, do a named ping, for example ping www.google.com

EVE ESXi VM Installation from ISO has 3 Phases

Phase 1 (Ubuntu installation)

Step 1: Power ON EVE VM. Chose Install EVE PRO Server and confirm with Enter.

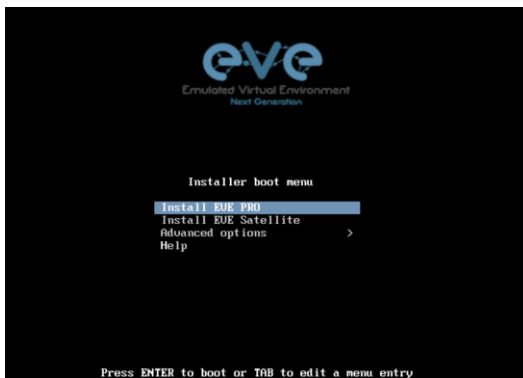

Step 2: Select English language. Confirm with Enter.

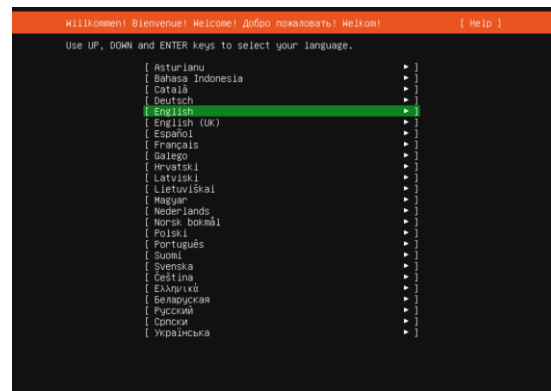

Step 3: Make sure if English US keyboard is selected and confirm with Enter.

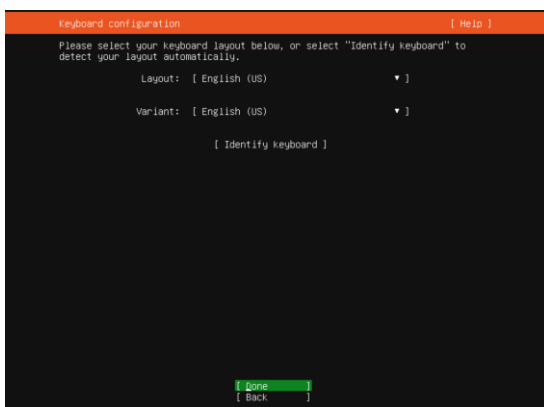

Step 4: If your network has **DHCP ENABLED**, Continue to **Step 10**

Step 5: If your network has not **DHCP**. Static IP setup. If you have not enabled DHCP in the network, you must assign an IP address manually. Use arrow UP key to

Step 6: Confirm interface selection with Enter, select "Edit IPv4" and confirm with Enter again.

select your interface for IP address assignment.

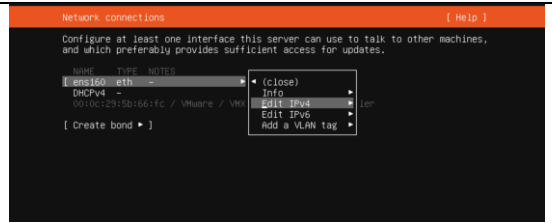
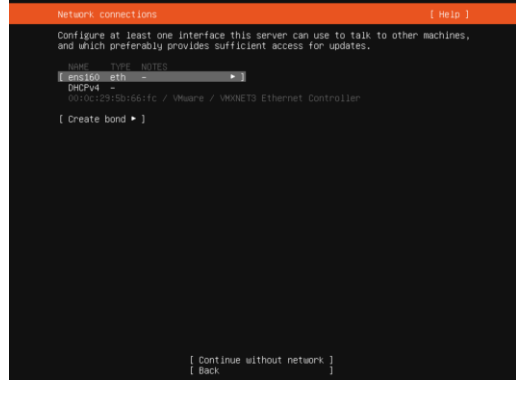

Step 7: Hit Enter on IPv4 Method and select "Manual", confirm with Enter.

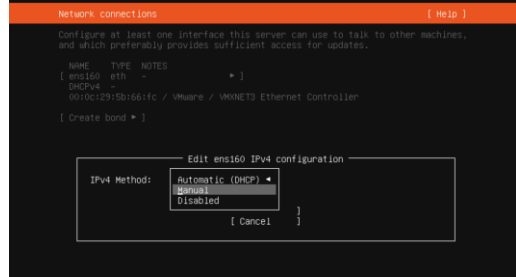

Step 8: Enter your "Subnet", "IP Address", "Gateway IP", "Domain server IPs" and "Search domain". Select "Save" and confirm with Enter. NOTE, it is very important that your DNS (Name servers) will resolve Internet names.

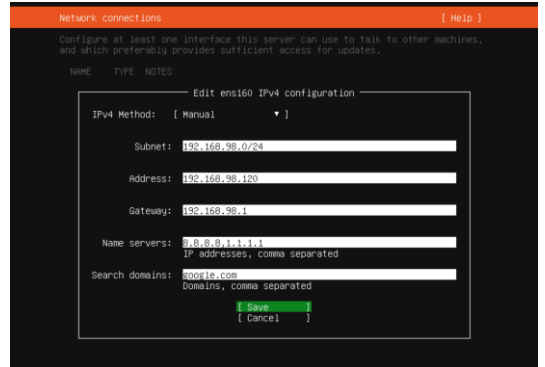

Step 9: Select “Done” and confirm with Enter

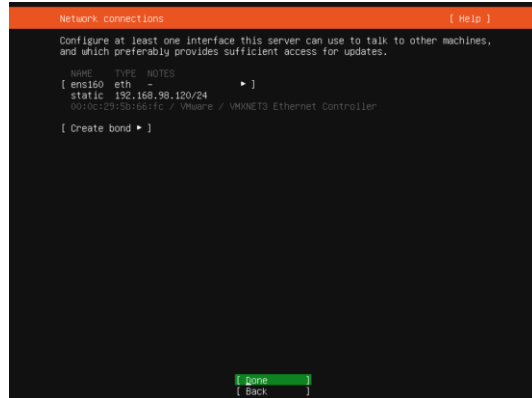

Step 10: If your DHCP IP settings are correct, select Done and confirm with Enter.

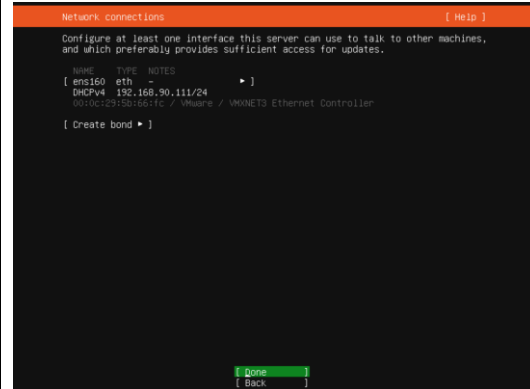

Step 11: If you have proxy in use for your internet, assign your network proxy settings. If no proxy in use, with Tab key select Continue and confirm with Enter.

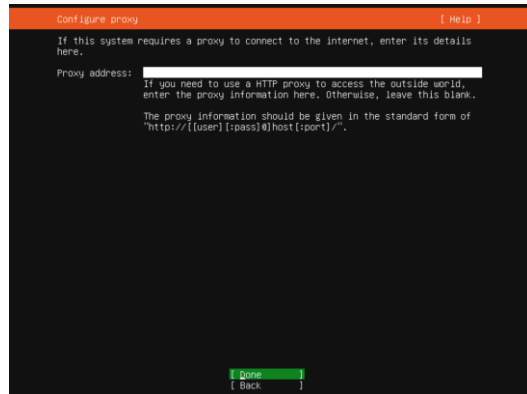

Step 12: Select “Continue” and confirm with Enter.

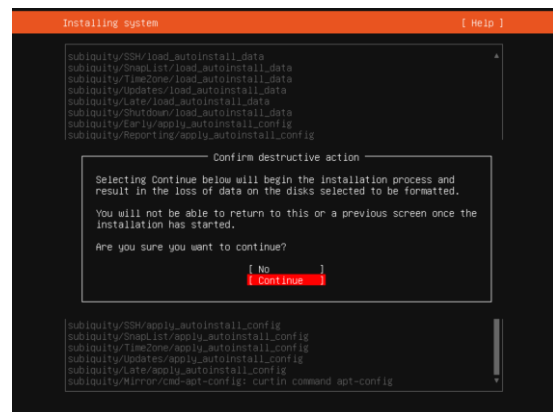

EVE VM Installation Phase 2 (EVE installation)

Step 13: After the Ubuntu “Install Complete” select “Reboot Now” and hit Enter to

Step 14: Without powering off the EVE VM, open the EVE VM settings and remove CD/DVD ISO Device. Save VM Settings.

Step 19: On the EVE CLI prompt, reboot EVE by typing

```
reboot
```

NOTE: Verify your EVE-NG server installation, type “dpkg -l eve-ng-pro” command, it must display latest EVE Pro version

```
root@eve-ng:~# dpkg -l eve-ng-pro
Desired=Unknown/Install/Remove/Purge/Hold
| Status=Not/Inst/Conf-files/Unpacked/halF-conf/Half-inst/trig-aWait/Trig-pend
|/ Err?=(none)/Reinst-required (Status,Err: uppercase=bad)
||/ Name Version Architecture
Description
+++-----
ii eve-ng-pro 4.0.1-3 amd64 A
new generation software for networking labs.
root@eve-ng:~#root@eve-sat01:~#
```

NOTE: If your newly installed EVE-PRO shows nothing like above, you must check your internet reachability and verify DNS configuration on your EVE-PRO server.

```
root@eve-ng:~# ping www.google.com
PING www.google.com (172.217.22.164) 56(84) bytes of data.
64 bytes from arn09s11-in-f164.1e100.net (172.217.22.164): icmp_seq=1
ttl=120 time=8.84 ms
64 bytes from arn09s11-in-f164.1e100.net (172.217.22.164): icmp_seq=2
ttl=120 time=8.84 ms
^C
--- www.google.com ping statistics ---
2 packets transmitted, 2 received, 0% packet loss, time 1001ms
rtt min/avg/max/mdev = 8.848/8.848/8.849/0.094 ms
root@eve-ng
```

Launch EVE-PRO installation manually

```
root@eve-ng:~# cd /etc
root@eve-ng:~# ./eve-setup.sh
```

Step 21: **IMPORTANT:** After update, Step 20 is completed, continue with type:

```
apt install eve-ng-dockers
```

This can take some time depending on your Internet connection and disk speed.

Your output after install must look like:

```
dc images
```

Step 22: (Optional) If after dockers first install (Step 21) in the output “dc images” you still seeing some docker name in the list as <none>,

```
root@eve-ng:~# dc images
TAG IMAGE ID CREATED SIZE
none none cc28666ac274 16 seconds ago 1.87GB
eve-gui-server latest 128e68e9355 7 minutes ago 3.04GB
eve-wireshark latest 638ed7c1580 12 minutes ago 897MB
eve-firefox latest 29293d71807 12 minutes ago 1.49GB
eve-desktop latest 762cc018a5 13 minutes ago 2.7GB
```

please run the command:

```
apt install --reinstall eve-ng-dockers
```

You must get output like in the step 21.

<pre>root@eve-ng:~# dc images REPOSITORY TAG IMAGE ID CREATED SIZE eve-desktop latest cca133621bd7 12 hours ago 3.45GB eve-pul-server latest 9db19c879a17 2 days ago 3.94GB eve-firefox latest 0266d109a1bb 7 weeks ago 2.12GB eve-redisdb latest 02a009773e09 7 weeks ago 1.56GB root@eve-ng:~#</pre>	
<p>Step 23: After Steps 20-22 are completed and you are back on the EVE CLI prompt, reboot EVE by typing</p> <pre>reboot</pre>	<p>NOTE: If you are installing EVE in the locked environment and cannot install dockers online, please contact with us: info@eve-ng.net for offline dockers installation option.</p>

Step 24: Go to section 4 to obtain a license for EVE-NG Professional

⚠ IMPORTANT NOTE: You must prepare and upload at least a couple of images to start building your labs. Refer to section 17

3.2.2 VMware ESXi OVF deployment

Download EVE-NG Professional OVF image zip file, and unzip it:
<https://www.eve-ng.net/index.php/download/>

3.2.2.1 ESXi OVF VM Setup and Settings

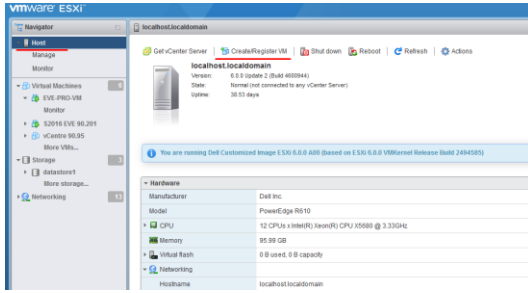
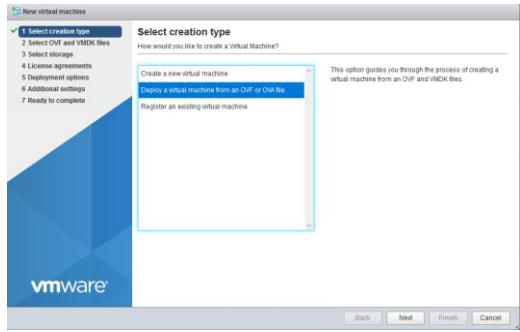
<p>Step 1: ESXi Host, Create/Register VM</p> 	<p>Step 2: Set option Deploy a virtual machine from an OVF or OVA file</p> 
--	---

<p>Step 3: Type the name for your new EVE VM and browse to select all your downloaded and unzipped EVE files.</p>	<p>Step 4: Select the storage where your EVE VM will be deployed.</p>
--	---

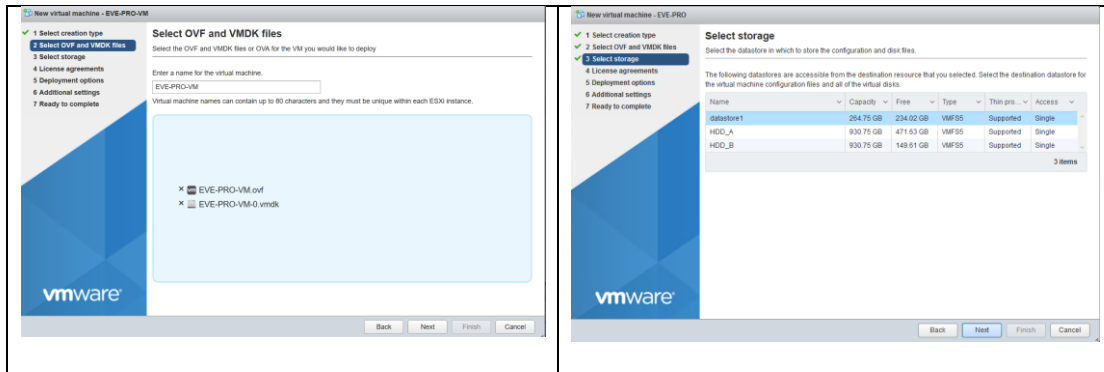

Step 5: Select your Management network and **Thick Disk provisioning**. EVE OVF HDD is only 40Gb large. It is recommended after installation to add extra HDD. Section **16.2**

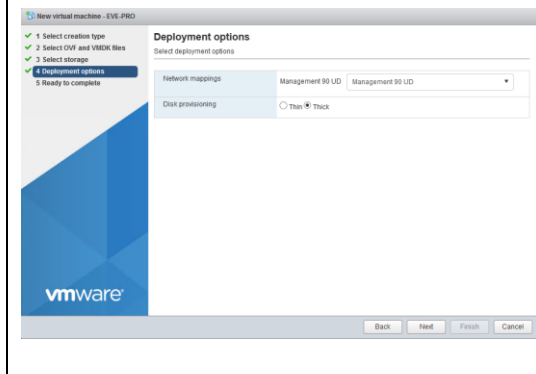

Step 6: **⚠ IMPORTANT** Open VM Settings. Set the quantity of CPUs and number of cores per socket. Set Intel VT-x/EPT Hardware Virtualization engine to ON (checked).

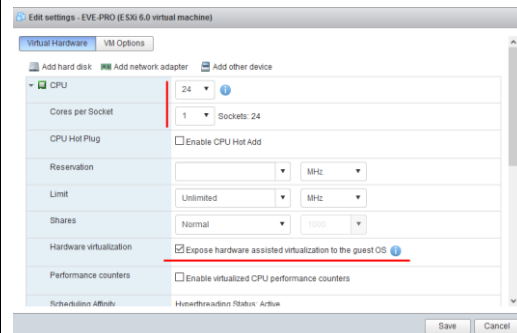

Step 7: Set desirable RAM for your EVE.

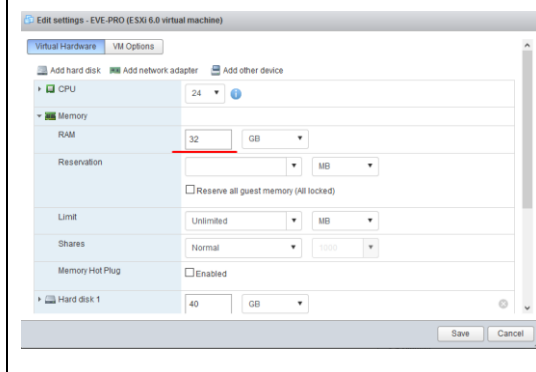

Step 8: Power ON your EVE VM and follow Management IP setup instructions described in section **3.5.1** for Static IP or **3.5.2** for DHCP IP.

Step 9: Proceed to section **4** "Obtain EVE-NG Professional license"

⚠ IMPORTANT NOTE: You must prepare and upload at least a couple of images to start building your labs. Refer to section **17**

3.2.2.2 ESXi OVF VM update to the latest EVE version

Make sure that your EVE OVF VM is up to date with the newest EVE version. Follow the steps described in section 5 for upgrade instructions

3.2.2.3 ESXi OVF VM HDD Size expansion

⚠ NOTE: IMPORTANT! DO NOT expand the current EVE OVF HDD. To expand your EVEs system disk size, please follow the troubleshooting section 16.2

3.3 Bare hardware (BM) server EVE installation

⚠ Mandatory Prerequisites: Internet must be reachable from your Server. This ISO installation requires internet access to get updates and install the latest EVE-PRO version from the EVE-NG repository. DNS must resolve names!

Download EVE Professional ISO
<https://www.eve-ng.net/index.php/download/>

Phase 1 (Ubuntu installation)

Step 1: Create a bootable DVD disk or USB flash drive with an Ubuntu server image. Boot your server from ISO. Chose Install EVE-NG Community Server and confirm with Enter.



Step 2: Select English language. Confirm with Enter.

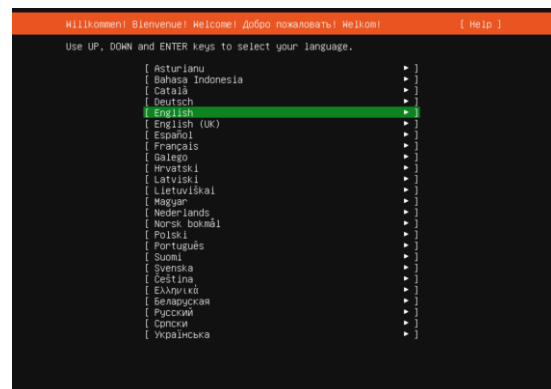

Step 3: Make sure if English US keyboard is selected and confirm with Enter.

Step 4: If your network has **DHCP ENABLED**, Continue to **Step 10**

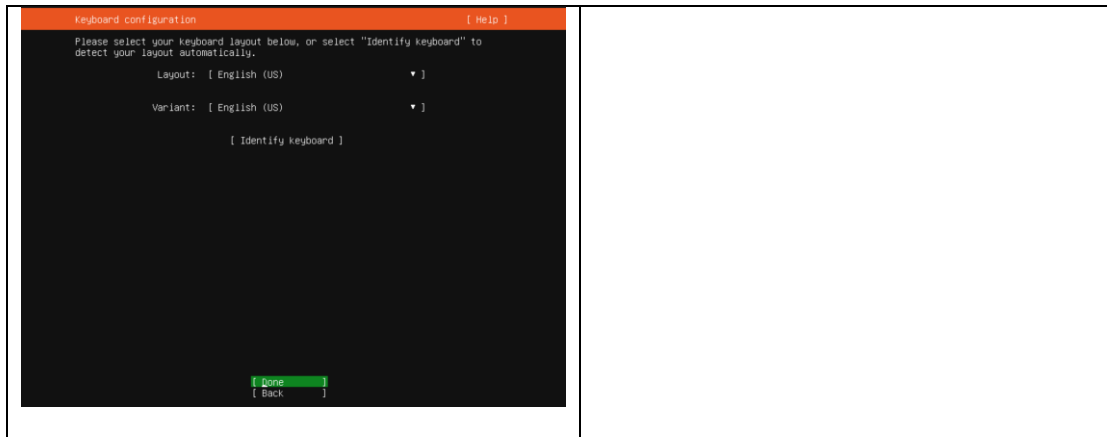

Step 5: If your network has not **DHCP**. Static IP setup. If you have not enabled DHCP in the network, you must assign an IP address manually. Use arrow UP key to select your interface for IP address assignment.

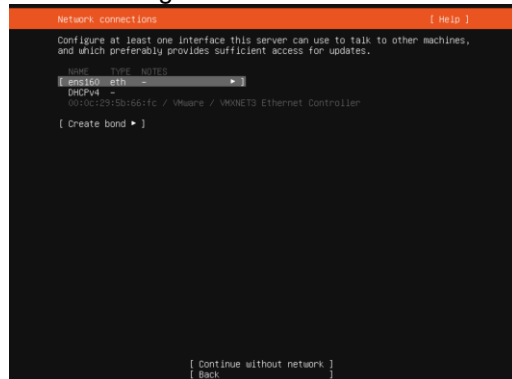

Step 6: Confirm interface selection with Enter, select "Edit IPv4" and confirm with Enter again.

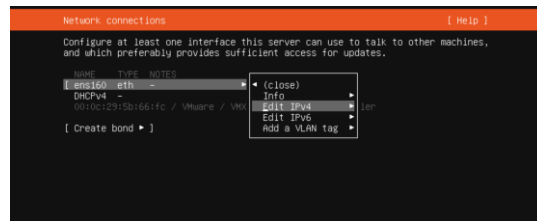

Step 7: Hit Enter on IPv4 Method and select "Manual", confirm with Enter.

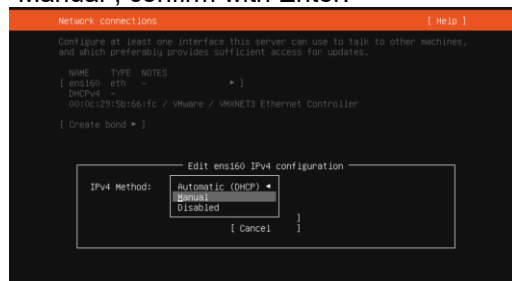

Step 8: Enter your "Subnet", "IP Address", "Gateway IP", "Domain server IPs" and "Search domain". Select "Save" and confirm with Enter. **NOTE, it is very important that your DNS (Name servers) will resolve**

Internet names.

Step 9: Select “Done” and confirm with Enter

Step 10: If your DHCP IP settings are correct, select Done and confirm with Enter.

Step 11: If you have proxy in use for your internet, assign your network proxy settings. If no proxy in use, with Tab key select Continue and confirm with Enter.

Step 12: Select “Continue” and confirm with Enter.

EVE VM Installation Phase 2 (EVE installation)

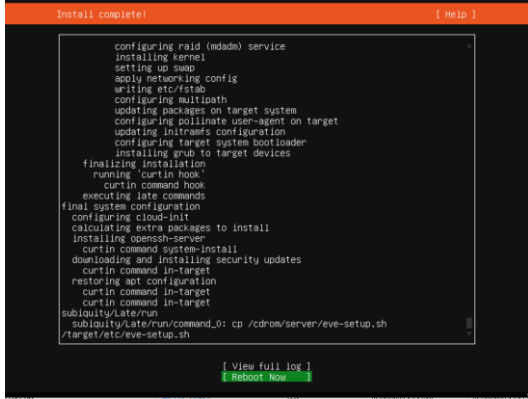
<p>Step 13: After the Ubuntu “Install Complete” select “Reboot Now” and hit Enter to continue.</p> 	<p>Step 14: Remove CD/DVD ISO Media.</p>
---	---

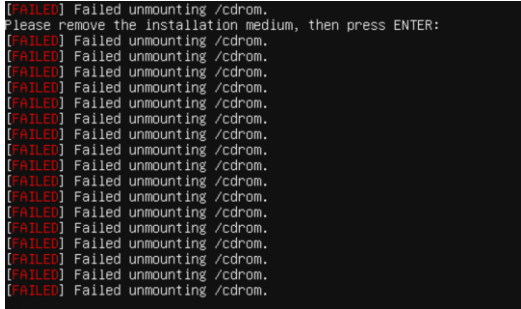
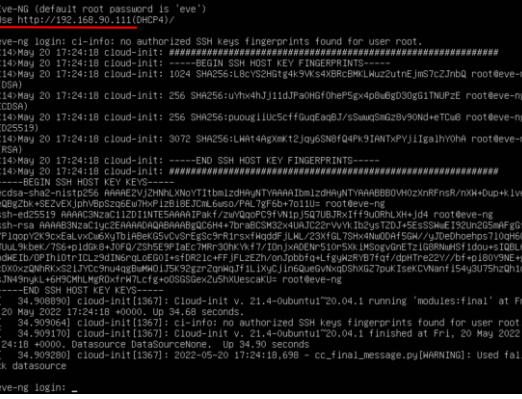
<p>Step 15: Return back to EVE console screen and confirm Continue with Enter, EVE VM will reboot and continue Phase 2 installation</p> 	<p>Step 16: Depending on your internet speed EVE installation will take some time. After installation EVE VM will auto reboot and EVE login screen will appear, login in CLI with <code>root/eve</code> and follow installation Phase 3</p> 
--	---

EVE Installation Phase 3 (Management IP setup and updates)

<p>Step 17: Setup EVE Management IP address. A Static IP address setup is preferred</p> <p>Follow steps in section : 3.5.1 for static IP, 3.5.2 for DHCP IP</p>	<p>Step 18: After your EVE is rebooted, Login to EVE CLI and type:</p> <pre>apt update apt upgrade</pre>
--	---

<https://console.cloud.google.com/getting-started>

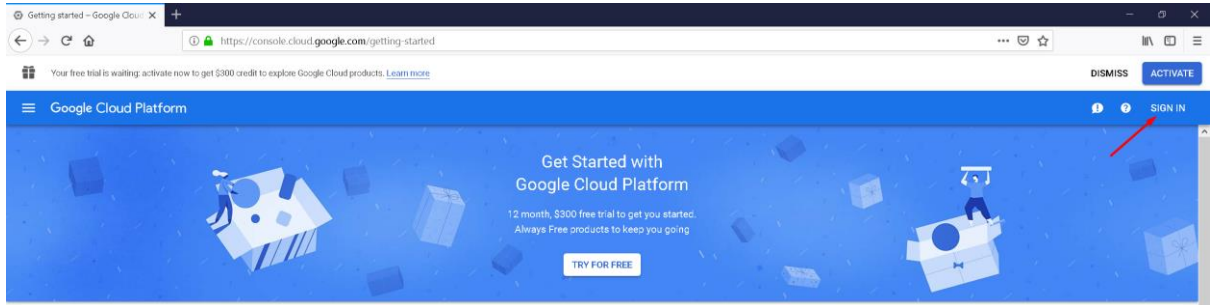

Step 2: Sign into GCP. Create a new GCP account if you do not already have one.

3.4.2 Goggle Cloud project

Create new project. By default, GCP will offer you a project named "My First Project". It can be used as well.

Step 1. GCP top bar, click on "My First Project"

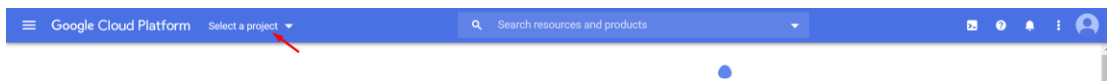

Step 2. Next pop up window, click "NEW PROJECT"



Step 3. Enter your project name, and confirm "CREATE"

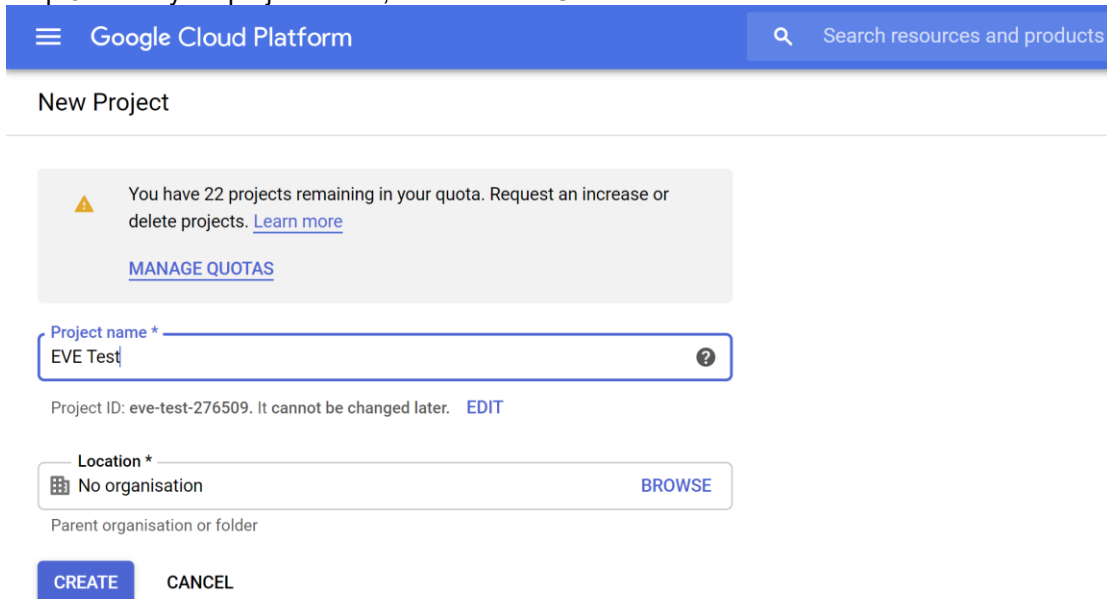

This will take some time.

3.4.3 Preparing Ubuntu boot disk template

Step 1: Open the google cloud shell and press: "START CLOUD SHELL"

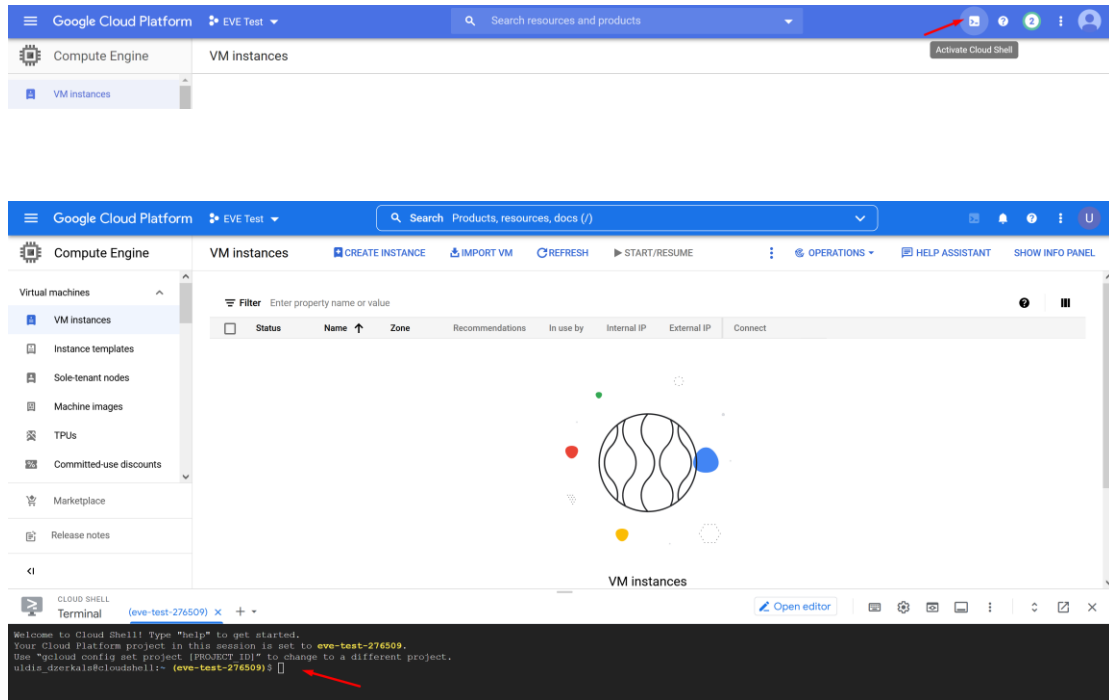

Step 2: create a nested Ubuntu 20.04 image model. Copy and paste the below command into the shell. Use copy/paste. ctrl +c/ctrl +v. **It is single line command.** Confirm with "enter":

```
gcloud compute images create nested-ubuntu-focal --source-image-family=ubuntu-2004-lts --source-image-project=ubuntu-os-cloud --licenses https://www.googleapis.com/compute/v1/projects/vm-options/global/licenses/enable-vmx
```

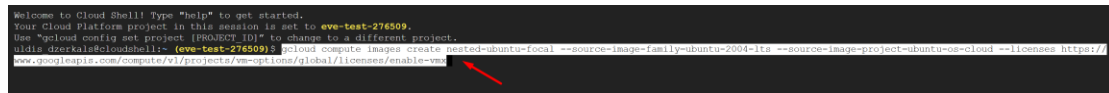

You will get the following output when your image is ready:

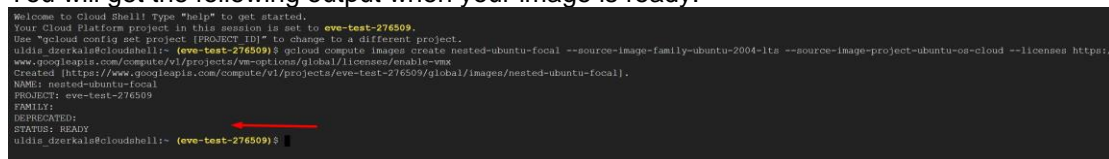

3.4.4 Creating VM

Step 1: Navigate: Navigation Menu/Compute Engine/VM Instances and press "Create"

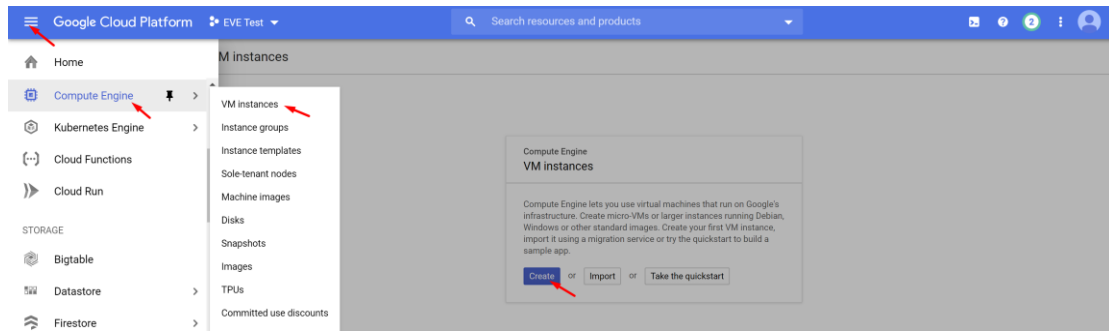

Step 2: Assign the name for your VM

Step 3: Set your own region and zone

Step 4: Edit your Machine Configuration. General-Purpose. Choose the series of CPU platform, Preferred are **Intel CPUs Skylake or Cascade**.

Step 5: Choose your desirable CPU and RAM settings.
IMPORTANT: "Deploy a container image" must be UNCHECKED.

Name *
eve-pro1

Labels ?
[+ ADD LABELS](#)

Region *
europe-west2 (London) ?
Region is permanent

Zone *
europe-west2-c ?
Zone is permanent

Machine configuration

Machine family

GENERAL-PURPOSE COMPUTE-OPTIMISED MEMORY-OPTIMISED GPU

Machine types for common workloads, optimised for cost and flexibility

Series
N2
Powered by Intel Cascade Lake and Ice Lake CPU platforms

Machine type
n2-standard-4 (4 vCPU, 16 GB memory)



vCPU
4

Memory
16 GB

✓ CPU PLATFORM AND GPU

Display device

Enable to use screen capturing and recording tools.

Enable display device ←

Step 6: Select Boot disk. Press Change

Boot disk ⓘ

Name	eve-com-5
Type	New balanced persistent disk
Size	10 GB
Image	Debian GNU/Linux 11 (bullseye)

CHANGE

Step 7. Select Custom images, Select Project (EVE-test) and the **custom boot images you created previously**. Choose HDD disk type and size. HDD size can vary depends of your needs.

Boot disk

Select an image or snapshot to create a boot disk, or attach an existing disk. Can't find what you're looking for? Explore hundreds of VM solutions in [Marketplace](#)

PUBLIC IMAGES **CUSTOM IMAGES** SNAPSHOTS EXISTING DISKS

SELECT A PROJECT

Show images from: EVE Test

Show deprecated images

Image *
nested-ubuntu-focal

Created on 21 May 2022, 10:10:47

Boot disk type * Size (GB) *
SSD persistent disk 50

SHOW ADVANCED CONFIGURATION

SELECT CANCEL

Step 8: Allow https traffic and create VM

Identity and API access ?

Service accounts ?

Service account

Compute Engine default service account

Requires the Service Account User role (roles/iam.serviceAccountUser) to be set for users who want to access VMs with this service account. [Learn more](#)

Access scopes ?

- Allow default access
- Allow full access to all Cloud APIs
- Set access for each API

Firewall ?

Add tags and firewall rules to allow specific network traffic from the Internet

- Allow HTTP traffic
- Allow HTTPS traffic

3.4.5 EVE-NG Pro installation

Step 1: Click VM Instances to get access SSH to your VM, Connect to the VM with the first option “Open in browser window”

Name	Zone	Recommendation	In use by	Internal IP	External IP	Connect
<input checked="" type="checkbox"/> eve-1	europe-west-2-c			10.154.0.3 (nic0)	35.189.102.127	SSH ⌵

```

Welcome to Ubuntu 20.04.4 LTS (GNU/Linux 5.13.0-1024-gcp x86_64)

 * Documentation:  https://help.ubuntu.com
 * Management:    https://landscape.canonical.com
 * Support:       https://ubuntu.com/advantage

System information as of Sat May 21 09:22:51 UTC 2022

System load: 0.15          Processes: 128
Usage of /:  3.6% of 48.29GB  Users logged in: 0
Memory usage: 1%          IPv4 address for ens4: 10.154.0.29
Swap usage: 0%

1 update can be applied immediately.
To see these additional updates run: apt list --upgradable

The list of available updates is more than a week old.
To check for new updates run: sudo apt update

The programs included with the Ubuntu system are free software;
the exact distribution terms for each program are described in the
individual files in /usr/share/doc/*/copyright.

Ubuntu comes with ABSOLUTELY NO WARRANTY, to the extent permitted by
applicable law.

uldis_dzarkais@eve-com-5:~$
  
```

Step 2: Launch installation with:

Type the below command to become root:

```
sudo -i
```

Start EVE-PRO installation

```
wget -O - - https://www.eve-ng.net/focal/install-eve-pro.sh | bash -i
```

Step 3: Update and upgrade your new EVE-Pro

```
apt update
```

```
apt upgrade
```

Confirm with Y

Step 4. Reboot EVE. Allow some time for reboot and then press "Reconnect"

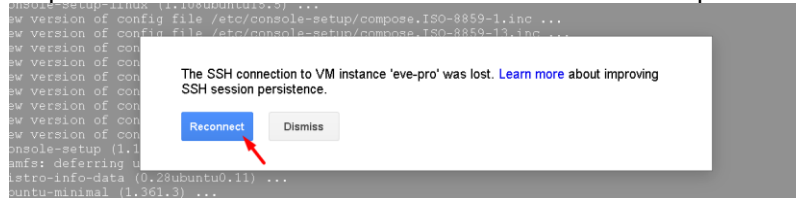

Step 5: **IMPORTANT**: Setup IP

Once the IP wizard screen appears, press **ctrl +c** and type the below command to become root:

```
sudo -i
```

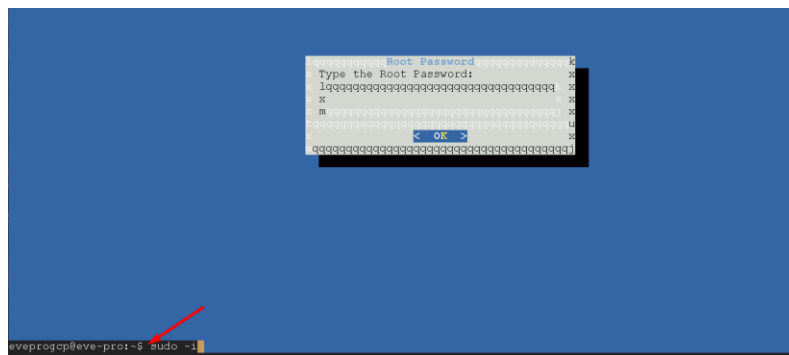

Now follow the IP setup wizard.

IMPORTANT: set IP as **DHCP**!

Step 6: Reboot

Step 7: Dockers installation. After EVE is rebooted, reconnect the SSH session:

Type command to become root:

```
sudo -i
```

Type command to update EVE

```
apt update
```

Type command to Install Dockers

```
apt install eve-ng-dockers
```

```
root@eve-ng:~# dc images
```

REPOSITORY	TAG	IMAGE ID	CREATED	SIZE
eve-desktop	latest	ca1338621bd7	12 hours ago	3.65GB
eve-nui-server	latest	8ab19e879e17	2 days ago	3.94GB
eve-terraform	latest	0266d108e1bb	7 weeks ago	2.12GB
eve-wireshark	latest	82a009773e89	7 weeks ago	1.56GB

```
root@eve-ng:~#
```

3.4.6 Access to Google Cloud EVE-PRO

Use your public IP for accessing EVE via https.

Filter VM instances							Columns
Name	Zone	Recommendation	In use by	Internal IP	External IP	Connect	
<input checked="" type="checkbox"/> eve-pro	europa-west2-c			10.154.0.2 (nic0)	<u>35.246.119.90</u>	SSH	

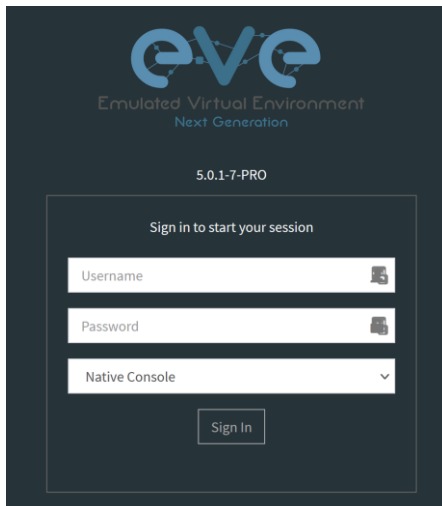

Default web login: **admin/eve**

3.4.7 Optional: GCP Firewall rules for native console use

Step 1: Navigate: Navigation menu/VPC Network/Firewall rules

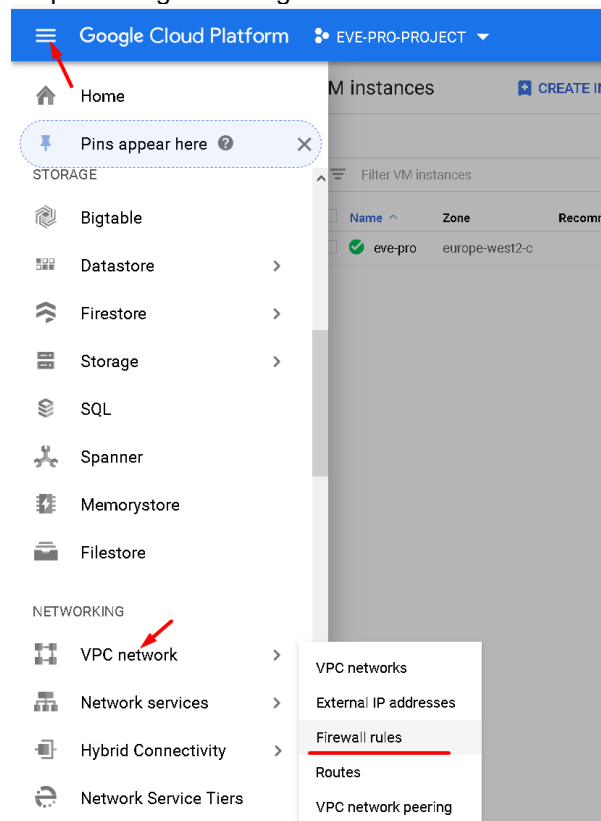

Step 2: Create new firewall rule

Firewall rules [+ CREATE FIREWALL RULE](#) [REFRESH](#) [DELETE](#)

Firewall rules control incoming or outgoing traffic to an instance. By default, incoming traffic from outside your network is blocked. [Learn more](#)

Note: App Engine firewalls are managed [here](#).

Step 3: Create an ingress FW rule; allow TCP ports 0-65535

← Create a firewall rule

Firewall rules control incoming or outgoing traffic to an instance. By default, incoming traffic from outside your network is blocked. [Learn more](#)

Name ?

Direction of traffic ?

Ingress 

Egress

Action on match ?

Allow

Deny

Targets ?

All instances in the network 

Source filter ?

IP ranges

Source IP ranges ?

0.0.0.0/0 

Second source filter ?

None

Protocols and ports ?

Allow all

Specified protocols and ports

tcp : 0-65535 

udp : all

Other protocols

protocols, comma separated, e.g. ah, scp

[Disable rule](#)

[Create](#) [Cancel](#)

Step 4: Create an egress FW rule; allow TCP ports 0-65535

Firewall rules control incoming or outgoing traffic to an instance. By default, incoming traffic from outside your network is blocked. [Learn more](#)

Name ?

Direction of traffic ?
 Ingress
 Egress

Action on match ?
 Allow
 Deny

Targets ?
 All instances in the network

Destination filter ?
 IP ranges

Destination IP ranges ?
 0.0.0.0/0

Protocols and ports ?
 Allow all
 Specified protocols and ports

tcp : 0-65535
 udp : all
 Other protocols
 protocols, comma separated, e.g. ah, sctp

⌵ Disable rule

Create Cancel

Summary FW rules.

<input type="checkbox"/>	Name	Type	Targets	Filters	Protocols / ports	Action	Priority	Network ^
<input type="checkbox"/>	egress-eve	Egress	Apply to all	IP ranges: 0.0.0.0/0	tcp:0-65535	Allow	1000	default
<input type="checkbox"/>	default-allow-https	Ingress	https-server	IP ranges: 0.0.0.0/0	tcp:443	Allow	1000	default
<input type="checkbox"/>	ingress-eve	Ingress	Apply to all	IP ranges: 0.0.0.0/0	tcp:0-65535	Allow	1000	default

3.5 EVE Management IP Address setup

3.5.1 Management static IP address setup (preferred)

⚠ IMPORTANT NOTE: EVE Docker stations for html console access are using network 172.17.0.0/16. Please avoid use this network on the EVE management or other clouds or interfaces.

The steps below will walk you through the network setup and assign a static management IP for EVE.

<p>Step 1: Log into the EVE CLI using the default login root/eve After login, type your preferred root password for EVE, default is eve. Remember it for further use. Confirm with enter</p> <p>NOTE: Typed characters in the password field are not visible.</p>	<p>Step 2: Retype your root password again and confirm with enter.</p>
--	--

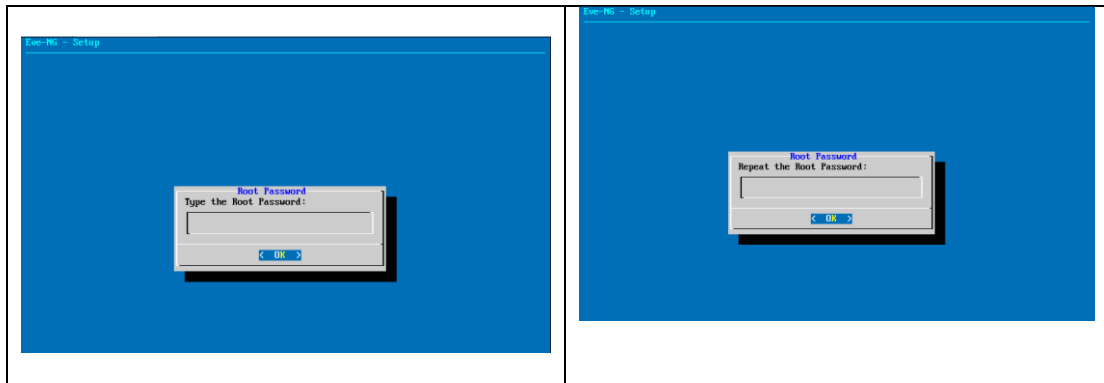

Step 3: Choose your EVE VMs hostname. By default, it is **eve-ng**. You can leave it as it is. Confirm with enter

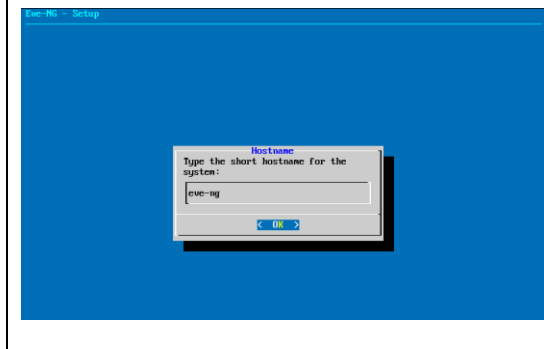

Step 4: Type your domain name for your EVE VM. By default, it is example.com. The default value can be used as well. Confirm with enter

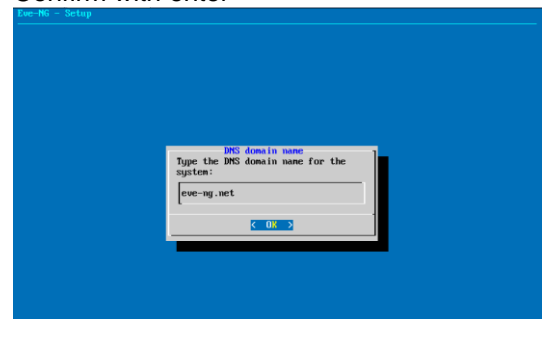

Step 5: Using the arrow keys, select the option "static", confirm your selection with the space key, followed by enter

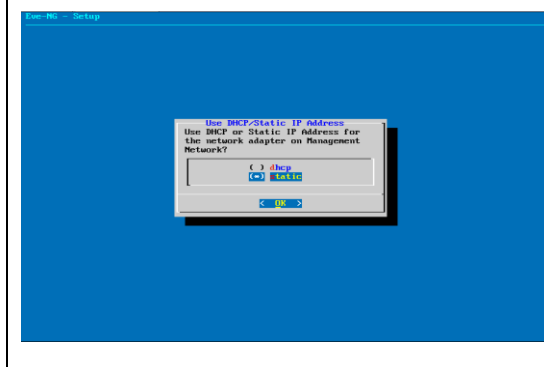

Step 6: Type your desirable EVE management IP. Confirm with enter.

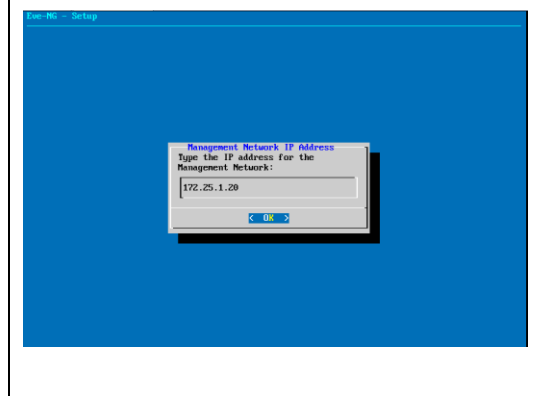

Step 7: Type the subnet mask of your EVE management network. Confirm with enter.

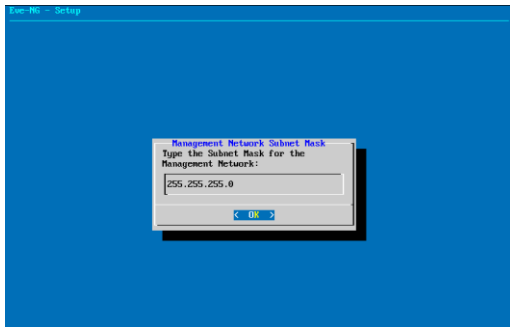

Step 8: Type your networks gateway IP. Confirm with enter.

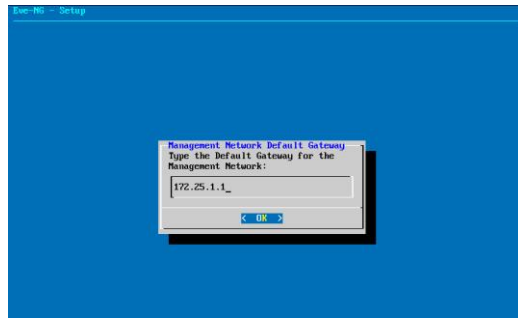

Step 9: Type your networks primary DNS IP. Confirm with enter.
IMPORTANT: DNS must be reachable and resolve public addresses.

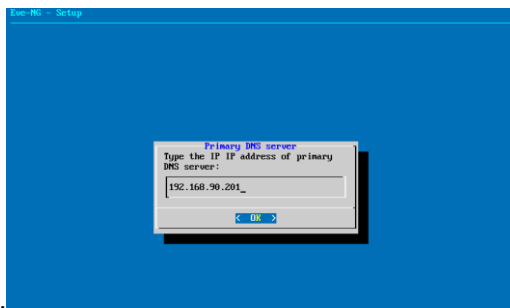

Step 10: Type your network Secondary DNS IP. Confirm with Enter.
IMPORTANT: DNS must be reachable and resolve public addresses.

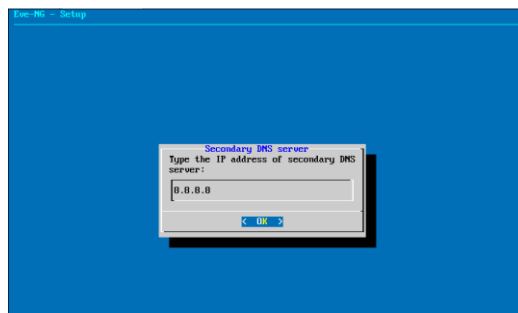

Step 11: Type your preferred NTP server IP. It can be left empty as well; in this case, your EVE VM will automatically assign the time from its host.

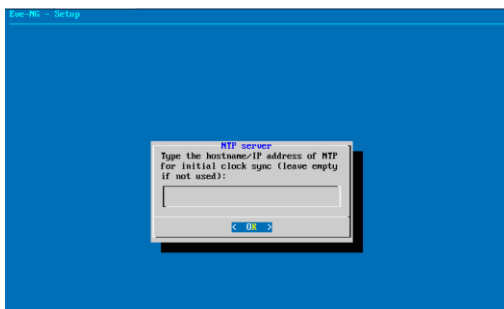

Step 12: **Skip this step.** By default, it is set to direct connection (no proxy).

Confirm selection with enter. EVE will reboot automatically.

NOTE: If required, the Proxy settings can be configured later using EVE WEB GUI System/System Settings described in section **3.5.3**

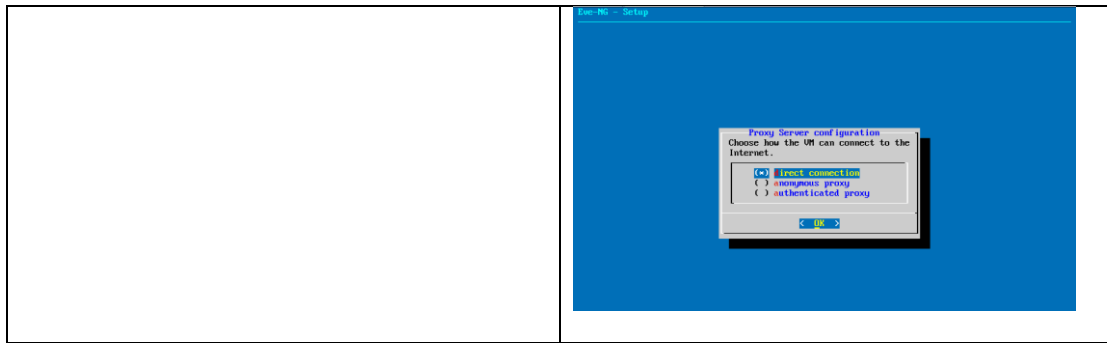

⚠ IMPORTANT NOTE: If you are setting up your management IP for the first time (fresh EVE installation), please return to the install section and complete installation **Phase 3**.

3.5.2 EVE Management IP address setup via DHCP

⚠ IMPORTANT NOTE: EVE Docker stations for html console access are using network 172.17.0.0/16. Please avoid use this network on the EVE management or other clouds or interfaces.

The steps below will walk you through the network setup and assign a management IP for EVE via DHCP.

Step 1: Log into the EVE CLI using the default login **root/eve**. After login, type your preferred root password for EVE, default is **eve**. **Remember it for further use.** Confirm with enter

NOTE: Typed characters in the password field are not visible.

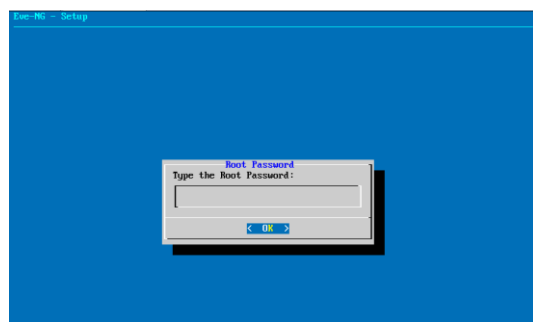

Step 2: Retype your root password again and confirm with enter.

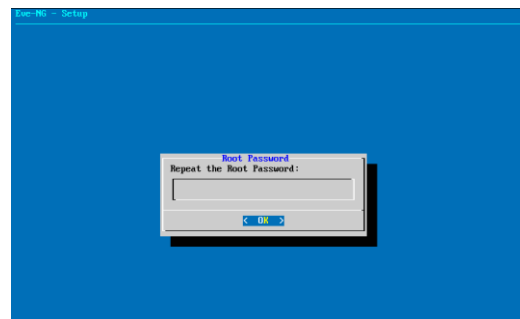

Step 3: Choose your EVE VMs hostname. By default, it is **eve-ng**. You can leave it as it is. Confirm with enter

Step 4: Type your domain name for your EVE VM. By default, it is **example.com**. The default value can be used as well. Confirm with enter

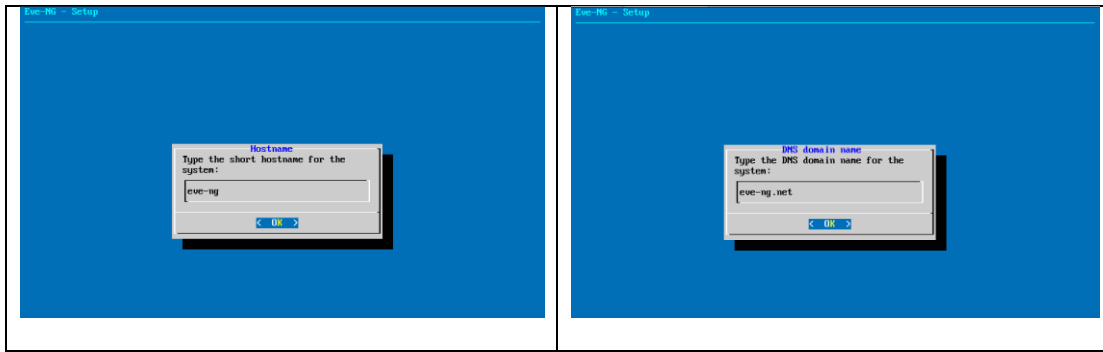

Step 5: Using the arrow keys, select the option “dhcp”, confirm your selection with the space key, followed by enter

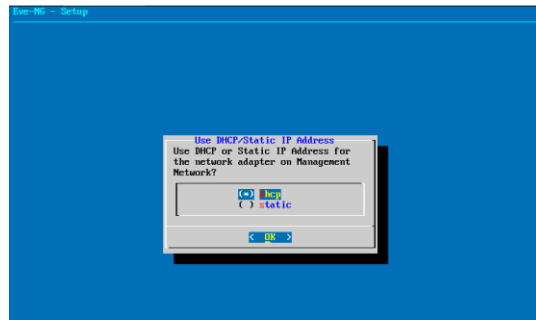

Step 6: Type your preferred NTP server IP. It can be left empty as well; in this case, your EVE VM will automatically assign the time from its host.

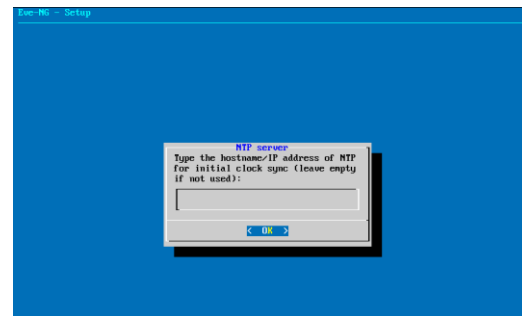

Step 7: **Skip this step.** By default, it is set to direct connection (no proxy).

Confirm selection with enter. EVE will reboot automatically.

⚠ NOTE: If required, the Proxy settings can be configured later using EVE WEB GUI System/System Settings described in section **3.5.3**

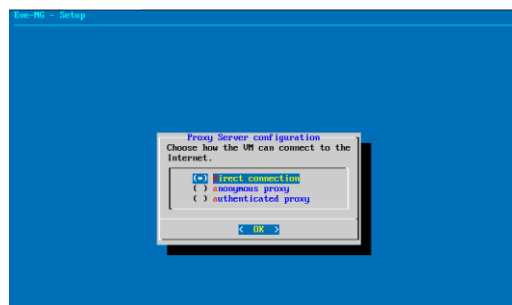

⚠ IMPORTANT NOTE: If you are setting up your management IP for the first time (fresh EVE installation), please return to the install section and complete installation **Phase 3**.

3.5.3 Internet proxy setup

Step 1: If you have a proxy in use for your Internet, login into your EVE WEB GUI using your EVE IP <https://aaa.aaa.aaa.aaa>

Default username: **admin**
Password: **eve**

Step 2: Select Tab: System/System Settings

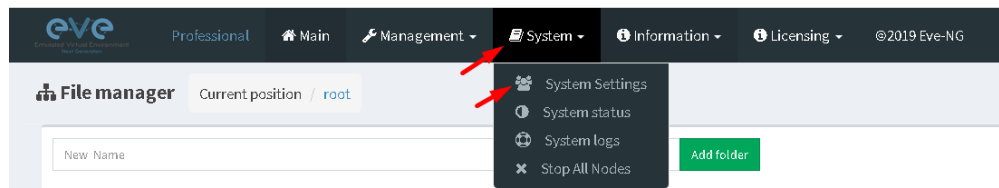

Step 3: Enter your Proxy IP and Port following by “Submit”. For authenticated Proxy, use your username and password.

System settings

Radius Server #1	IP <input type="text" value="0.0.0.0_"/>	Port <input type="text" value="1812"/>	Secret <input type="password" value="....."/>
Radius Server #2	IP <input type="text" value="0.0.0.0"/>	Port <input type="text" value="1812"/>	Secret <input type="password" value="....."/>
Proxy Server	IP <input type="text" value="0.0.0.0_"/>	Port <input type="text" value="8080"/>	User <input type="text"/>
			Password <input type="password"/>
Template visibility	unprovisioned images <input type="text" value="Disable"/>		
Disk critical size	Minimal free space (GB) <input type="text" value="5"/>		
Html 5 terminal setting	Color scheme <input type="text" value="gray-black"/>		
	Font name <input type="text" value="monospace"/>		
	Font size <input type="text" value="12"/>		
Management Interface setting	Enable IPV6 <input type="checkbox"/>		

3.5.4 EVE Management IP address reset

If for any reason you need to change these settings after the installation, you can rerun the IP setup wizard. Type the following command in the CLI and hit enter:

```
rm -f /opt/ovf/.configured
```

Then type:

```
su -
```

Once you log into the CLI again, EVE will go through the network setup again. Please follow the steps in section [3.5.1](#) for Static IP or [3.5.2](#) for DHCP IP.

3.6 Native telnet console management setup

If you prefer to use a natively installed telnet client to manage nodes inside EVE, follow the steps below:

3.6.1 Windows Native Console

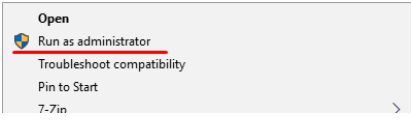
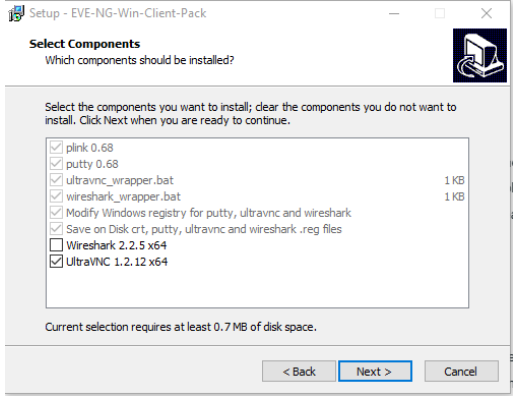
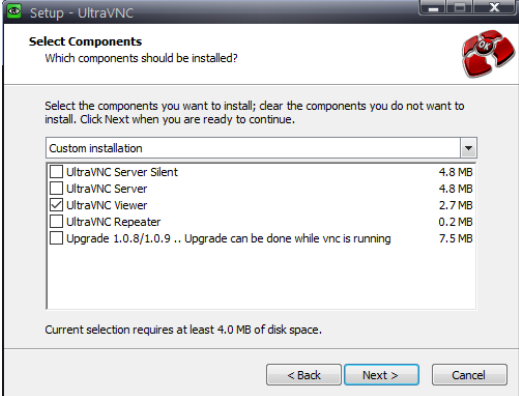
<p>Step 1: Download the EVE Windows Client integration pack:</p> <p>http://www.eve-ng.net/downloads/windows-client-side-pack</p>	<p>Step 2: Install it as administrator</p> 
<p>Step 3: Leave the option for UltraVNC checked. UltraVNC is very tiny and the preferred VNC client for Windows by EVE.</p>  <p>NOTE: The Wireshark option for EVE Professional is left unchecked, because Wireshark is already integrated into EVE PRO.</p>	<p>Step 4: Continue with Next. When it asks to choose Ultra VNC Options, only leave the UltraVNC Viewer checked, the rest is not needed.</p> 

Step 5: Continue with Next and finish the installation.	
---	--

By default, EVE Windows Client Integration will install **Putty** as your Telnet Client. The default location for the EVE Windows Client Integration software and .reg files is: "C:\Program Files\EVE-NG"

Set the default telnet program manually in Windows 10. Example: SecureCRT

Step 1: Go to: Windows Settings/Apps/Default Apps/Choose Default Apps by Protocol

Step 2: Set your default Telnet program:



! NOTE: The first time click on the type of link that is used to access a running node inside EVE via telnet, the browser will ask to choose the telnet program. If you have prepared your default telnet program with the instructions above, you have to choose your default Telnet program.

Example: Firefox browser:

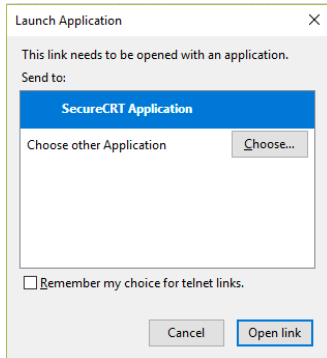

Set your default application, check the box "Remember my choice telnet links" and click Open link

3.6.2 Linux Native Console

The steps below will show how to setup the native consoles pack for Linux Mint 18 (Ubuntu):

Step 1: Go to the EVE Linux Side integration pack download page: http://www.eve-ng.net/downloads/linux-client-side	Step 2: Open the link to GitHub https://github.com/SmartFinn/eve-ng-integration
Step 3: Scroll down to the installation part	

<p>Installation</p> <p>Ubuntu and derivatives</p> <p>You can install eve-ng-integration from the official PPA:</p> <pre>sudo add-apt-repository ppa:smartfinn/eve-ng-integration sudo apt-get update sudo apt-get install eve-ng-integration</pre>	
<p>Step 4: Login as root to your Linux system and enter the commands below:</p> <p>NOTE: An internet connection is required. Enter each command line below one after the other</p> <pre>sudo add-apt-repository ppa:smartfinn/eve-ng-integration</pre> <pre>sudo apt-get update</pre> <pre>sudo apt-get install eve-ng-integration</pre>	

⚠ For other Linux native console setup options please refer to:
<https://github.com/SmartFinn/eve-ng-integration>

3.6.3 MAC OSX Native Console

Download the EVE MAC OSX Client integration pack and install it:

<https://www.eve-ng.net/index.php/download/#DL-OSX>

3.7 Login to the EVE WEB GUI

EVE PRO is using https 443. Login to the EVE management UI:

`https://<your_eve_ip>/`

Default user access:

User: admin

Password: eve

- ⚠ **NOTE:** You can change your EVE Admin password, please refer to section **7.3.1.2**
- ⚠ **IMPORTANT NOTE:** You must prepare and upload at least a couple of images to start building your labs. Refer to section **17**

4 EVE-NG Professional Licensing

EVE-NG Professional and Learning Centre editions require purchasing and uploading a license to activate its features. Licenses are based on an annual subscription.

EVE-NG permits up to **128 accounts** to be created but restricts the number of simultaneous sessions per role to the licensed amount. To increase the number of active sessions, please purchase additional licenses on top of the base license as shown below.

⚠ Definition: Simultaneous session (1 license) means one active connection to the EVE-NG Web GUI.

License information	
Expiry Date:	20190507
Admins:	2
Editors:	0
Users:	0

Example1 EVE-Professional: The license information page shows 2 Admin accounts. This means 2 Admin role-based accounts can be logged into the Web GUI simultaneously. If a third Admin account logs into the Web GUI, the first active Admin session will be disconnected. Please note that the first Admin's labs will keep running. EVE-NG PRO can have up to 128 accounts, but active sessions to the Web GUI are restricted to the number of purchased licenses.

License information	
Expiry Date:	20190507
Admins:	2
Editors:	0
Users:	3

Example2 EVE Learning Centre: The license information page shows 2 Admin and 3 Lab-user role accounts. This means 2 Admin and 3 User accounts can be logged into the Web GUI simultaneously. If a fourth User account or third Admin account logs into the Web GUI, the first User or Admin session will be disconnected. Started labs will keep running. EVE-NG Learning Center can have up to 128 accounts, but active sessions to the Web GUI are restricted by the number of licenses purchased.

4.1 EVE-NG Professional Base license

EVE-NG Professional Edition - 1 Year License

<https://www.eve-ng.net/index.php/buy/>

EVE-NG PRO features multi user support and assigns all accounts as Administrators. The license allows for 2 simultaneous users.

Products in your shopping cart		
×	EVE-NG Professional Edition - 1 Year License EVE-NG Professional Edition - 1 Year License This license unlocks all Pro features and two active Administrator accounts sessions. The Administrator role can manage everything in EVE-NG without restriction. This includes creating, deleting, and modifying all folders, labs, nodes and accounts.	1 \$109.66
<input type="checkbox"/> I have a discount coupon		Total price: \$131.59 Total TAX/VAT (20%) : \$21.93

For EVE-PRO Administrator role permissions, please see section **4.4**.







4.2 EVE-NG Learning Centre licenses

EVE-NG Learning Centre Edition - 1 Year License

<https://www.eve-ng.net/index.php/buy-corporate/>

EVE-NG LC features multi user support and assigns accounts as Administrators, Lab-Editors or Lab-Users.

The first minimal Base A license allows for 2 simultaneous Admin users. It is necessary to use an Administrator account to create or manage EVE LC and other user's role-based accounts.

	EVE-NG Professional Base - 1 Year License	1	99,00 €
	<p>This license unlocks all Pro features and two active Administrator accounts sessions.</p> <p>EVE-PRO allows up to 128 accounts to be created but restricts the number of active sessions, per role, to the licensed amount. To increase the number of simultaneous account sessions, please purchase additional licenses below.</p>	Minimum Mandatory Base license	
	Optional Licenses	Change quantity	Remove from order if no need this option
	EVE-NG PRO Administrator - 1 Year License <p>This license unlocks one additional active session for the Administrator role.</p> <p>The Administrator role can manage everything in EVE-NG without restriction.</p> <p>This includes creating, deleting, and modifying all folders, labs, nodes and accounts.</p> <p>The Administrator is the only role that can create or modify accounts.</p>	<input type="button" value="-"/> 1 <input type="button" value="+"/>	99,00 € 
	EVE-NG PRO Lab Editor - 1 Year License <p>This license unlocks one additional active session for the Editor role.</p> <p>The Editor role is restricted to a personal folder and is authorized to create, delete, or modify additional folders, labs, and nodes within it.</p>	<input type="button" value="-"/> 1 <input type="button" value="+"/>	350,00 € 
	EVE-NG PRO Lab User - 1 Year License <p>This license unlocks one additional active session for the User role.</p> <p>The User role is restricted to a personal folder and is only authorized to start, stop, and wipe nodes. An Administrator account is required to manage folders and labs within a Users folder.</p>	<input type="button" value="-"/> 1 <input type="button" value="+"/>	300,00 € 

EVE-NG PRO – A Base License (Mandatory)

This license unlocks all Pro features and two active Administrator accounts sessions. This license is mandatory for EVE LC edition.

The following licenses below can vary per your needs.

EVE-NG PRO - Administrator License

This license unlocks one additional active session for the Administrator role. The Administrator role can manage everything in EVE-NG without restrictions. This includes creating, deleting, and modifying all folders, labs, nodes and accounts. The Administrator is the only role that can create or modify accounts.

EVE-NG PRO – Lab-Editor License

This license unlocks one additional active session for the Lab-Editor role. The Lab-Editor role is restricted to a personal and the Shared folder and is authorized to create, delete, or modify additional folders, labs, and nodes within them.



EVE-NG PRO – Lab-User License

This license unlocks one additional active session for the Lab-User role. The Lab-User role is restricted to a personal and the Shared folder and is only authorized to start, stop, and wipe nodes. An Administrator account is required to manage folders and labs within a User's personal folder.

Example: EVE Learning Centre Licensing for 1 Teacher and a 5 Students class.

Licence model below includes:

- Two administrator accounts, necessary for EVE LC labs and other user account management
- One Lab-Editor-role based account, assigned to the teacher to create/manage labs and assign them to the Shared folder for Students use. The Lab-Editor role is restricted to a personal folder and is authorized to create, delete, or modify additional folders, labs, and nodes within it.
Optional: If wanted / needed, the Lab-Editor account for the teacher can also be replaced by an Administrator account instead.
- Five Lab-User role-based Student accounts allowing running a class with 5 simultaneous students connected to the EVE HTML GUI.

	<p>EVE-NG Professional Base - 1 Year License This license unlocks all Pro features and two active Administrator accounts sessions. EVE-PRO allows up to 128 accounts to be created but restricts the number of active sessions, per role, to the licensed amount. To increase the number of simultaneous account sessions, please purchase additional licenses below.</p>	1	99,00 €
	<p>EVE-NG PRO Lab Editor - 1 Year License This license unlocks one additional active session for the Editor role. The Editor role is restricted to a personal folder and is authorized to create, delete, or modify additional folders, labs, and nodes within it.</p>	- 1 +	350,00 €
	<p>EVE-NG PRO Lab User - 1 Year License This license unlocks one additional active session for the User role. The User role is restricted to a personal folder and is only authorized to start, stop, and wipe nodes. An Administrator account is required to manage folders and labs within a Users folder.</p>	- 5 +	1.500,00 €

For EVE-LC role permissions, please see section **4.4**.

4.3 EVE-NG Corporate licenses

Essentially, this is EVE Learning Centre edition with Lab-Editor role-based accounts only. This is recommended for corporate use to allow full permissions for EVE labs but to restrict being able to manage other user accounts or labs. The Lab-Editor role is restricted to a shared and a personal folder and has permissions to create, delete, or modify additional folders, labs, and nodes within them.

EVE-NG Learning Centre Edition - 1 Year License

<https://www.eve-ng.net/index.php/buy-corporate/>

EVE-NG Corporate features multi user support and assigns accounts as Administrators or Lab-Editors.

The first (mandatory) Base A license allows for 2 simultaneous Admin users. It is necessary

to have an Administrator account to create or manage EVE LC and other user's role-based accounts.

Example: EVE Corporate Licensing for 5 Lab-Editor users.

License model below includes:

- Two administrator accounts necessary for EVE Corporate labs and other user accounts management (Mandatory Base license)
- Five Lab-Editor role-based accounts. The Lab-Editor role is restricted to a shared and a personal folder and has permissions to create, delete, or modify additional folders, labs, and nodes within them.



EVE-NG Professional Base - 1 Year License

This license unlocks all Pro features and two active Administrator accounts sessions.

EVE-PRO allows up to 128 accounts to be created but restricts the number of active sessions, per role, to the licensed amount. To increase the number of simultaneous account sessions, please purchase additional licenses below.

1

99,00 €



EVE-NG PRO Lab Editor - 1 Year License

This license unlocks one additional active session for the Editor role.

The Editor role is restricted to a personal folder and is authorized to create, delete, or modify additional folders, labs, and nodes within it.

-
5
+

1.750,00 €

EVE Corporate role rights, please follow section [4.4](#).

4.4 User roles comparison chart

Feature	Administrator Role	Lab-Editor/Teacher role	Lab-User/Student role
User accounts management	yes	no	no
User Accounts visibility	yes	no	no
User edit modal visibility	yes	no	no
User Folder's management	yes	no	no
Full EVE root folder tree access	yes	no	no
Licencing module access	yes	no	no
Nodes management module access	yes	yes (only own running nodes)	yes (only own running nodes)
Lab management module access	yes	yes (only own running nodes)	yes (only own running nodes)
Shared lab folder management	yes	yes	no
Shared folder access	yes	yes	yes
Rename Folders	yes	yes	no
Create labs	yes	yes	no
Delete labs	yes	yes	no
Edit Custom topology mapping	yes	yes	no
Use only Custom topology mapping	yes	yes	yes

Lab objects management add text, drawing on labs	yes	yes	no
Export/import labs	yes	yes	no
Nodes list management	yes	yes	yes, read-only
Networks management	yes	yes	yes, read-only
Start labs	yes	yes	yes
Stop labs	yes	yes	yes
Wipe nodes	yes	yes	yes
Console to all nodes	yes	yes	yes
Export all configs	yes	yes	no
Edit lab	yes	yes	no
Set nodes startup-cfg to default configset	yes	yes	no
Set nodes startup-cfg to none	yes	yes	no
Topology refresh	yes	yes	yes
Topology zoom	yes	yes	yes
EVE status	yes	yes	yes
Lab details UUID	yes	yes	yes
See startup configs	yes	yes	no
Delete default startup configs	yes	yes	no
Create and manage multiconfig sets	yes	yes	no
Close labs	yes	yes	yes
Lock labs	yes	yes	no
System/Stop all nodes	yes	no	no
Information tab access	yes	yes	yes
Work with more than one lab	yes	yes	yes
Lab timer function	yes	yes	no
Lab background dark mode	yes	yes	yes
Hide node labels	yes	yes	Yes
EVE Cluster administration	Yes	No	No

4.5 License purchasing and activation

- ⚠ Before purchasing a license, the customer must have **EVE-NG Professional** installed and readily accessible.
- ⚠ Recommended browser for license operations are: Chrome or Mozilla Firefox
- ⚠ You must be logged in to the EVE WEB GUI as Administrator.

Step 1: Obtain your license request from the Licensing tab of the top menu of the EVE PRO WEB GUI. License requests will work only if the host machine (and hypervisor if running a VM) has **Intel VT-x/EPT** enabled!
(See section **3** for details)

Step 2: Copy the content of the license request and keep it ready for the order process at **Step 6**. Orders without a license request cannot be processed.

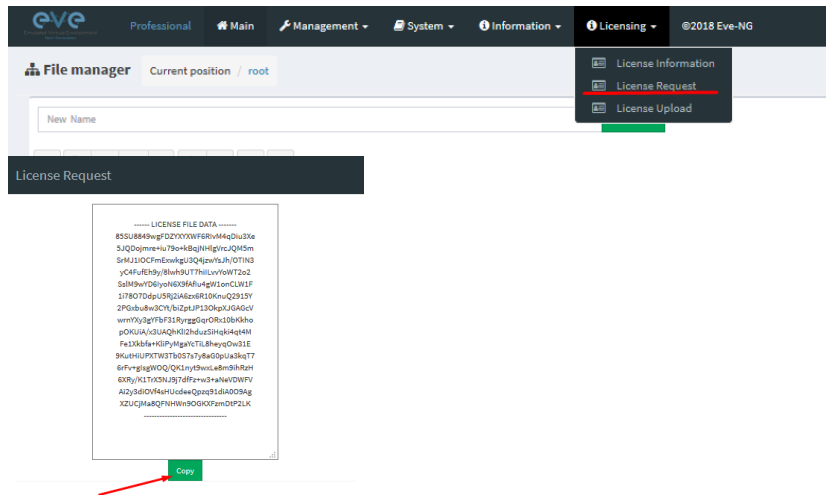

Step 3: Go to the EVE PRO or Learning Centre Purchase Portal and choose your Licenses and quantity.

Licenses that are unnecessary for your EVE Learning Centre or Corporate Edition licensing needs, can simply be deleted from your order by clicking on the cross next to them to remove them. Refer to sections: **4.2** and **4.3**

[EVE-PRO Purchase Portal](#)

[EVE-Learning Centre or Corporate Purchase Portal](#)

Step 4: Choose your preferred payment method. We currently support VISA, Mastercard, Bank/Wire transfer and PayPal.



Step 5: Complete the order form. If your license is for commercial/company use, you must select Company option.

Billing Information

Licensed to: Person Company

First name*:

Last name*:

Address*:

Step 6: At the end please paste your **license request content (including header and footer lines)** from Step 2 and **Please read** and confirm the [EULA agreement](#), which contains vital information about licenses. For companies, if necessary, in the Order Notes you can add additional information/reference, e.g. for your accounting department.

Additional Information

Order Notes
Order Notes

EVE-NG PRO A Base license

License Request*
--- LICENSE FILE DATA --- →

[Accept EULA*](#)

Step 7: After a while (usually 10-30 mins), your license is sent to the E-Mail used in the order form.

- ⚠ **IMPORTANT:** Before loading the purchased license, make sure your EVE has Internet access. Your EVE DNS settings must be configured properly to resolve the FQDN. Internet connection is required to validate your EVE license with our EVE-NG license server.
- ⚠ **IMPORTANT:** If your EVE internet is using Proxy, make sure you have set the proxy settings described in section **3.5.3**
- ⚠ Offline EVE Pro license is supported for Bare EVE installs only. (Dedicated EVE server). VM Ware and Cloud environment EVE installs require Internet connection.

Step 8: Copy ALL Content of your received License. Important: License key must include header and bottom lines as well.

```
EVE-NG Professional Edition - 1 Year License
----- LICENSE FILE DATA -----
X26X8Y28Jraqm9g6gwQ7SFSBKDayKnWX
92ep0MvFvex8jngmD5xmEHQczkmSEmEt
SFwPzm5odick8+YozEVE08CSUIPepY2
Z79ddXrADJjsSKKvdpSPve9p9MYO7b
7E5ggjXncOUl8KH1SjUsz28HLKfcdz
1TQD8S+AP/AM8T4CAez20uaEioeLkuAgS
1x/d13uaONkeALTSdniKNjs4hXIAKfcq
hG9v6lZkwOCiYwGo6kbGvVxj8JtXpD8
n6Wt84iCWPIYbalsqtgwuMJAk11QqG0
8prut/YELc8uPTV0m8QDH/2GJ0IXRpo
evacuHdgJkEv89zL0ZZ7YwrMJ0IZRnRK
1As78CSErV9XQJ5rTZ3AQ8FjVvAoy
agvuHtgWjfm/9mTisf7GOTIPoxKqJT7
6OG+dihyveFFi3BuLdJTDx8BwX48HF1L
34nzQFDUSL0PyL4uLc8V1rYYArXuct
a+RNz8KjyR42EeL.OhrWFQwHIUQoajqs
mlnq+JMrl9e7djyxkh/R8cnxClmKn5VX
0lCaEToa0J3XvQAU2IQxyXr7qxfdo0Jt
HOQAROVV1VOnsAjciUWmrm6l6=
```

Step 9: On your EVE WEB GUI, click on License Upload,

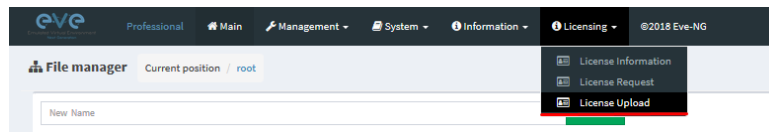

Paste your licence and click on Upload

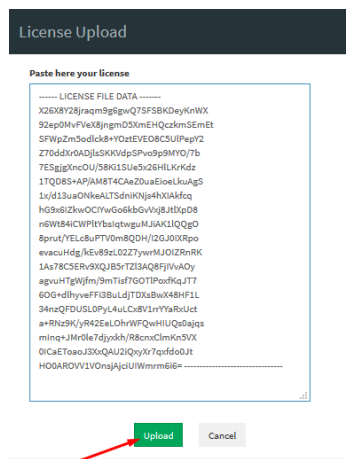

4.6 License deactivation

If you decide to deactivate EVE-PRO license on the host, please follow the steps below:

- ⚠ Go to EVE CLI and type:

```
cd /opt/unetlab/html/
```

```
rm eve-ng.lic  
cp eve-ng.nolic eve-ng.lic
```

4.7 License Rehosting.

If you decide to re-install EVE-PRO or move it to another host, please follow the steps below:

⚠ Pre-requisites:

- EVE must have internet access!
- Only ONE EVE host must be turned ON and connected to the internet, do NOT have more than one EVE with the same license turned on at the same time!

Step 1. Make sure that you have only ONE EVE-PRO instance with this license running.

Step 2. Make sure you have unrestricted Internet access with a properly configured DNS server from your EVE server.

Step 3. Load your purchased license onto EVE server you want to rehost to.

Step 4. Reboot your new EVE

Step 5. Wait approximately one hour for the licence validation process to finish on the host.

- ⚠ NOTE:** The re-hosted EVE server must have internet access to periodically validate the license. EVE receives a token with a licence validity time of 24 hours. During those 24 hours, the re-hosted EVE can be used offline. After 24 hours the token time expires and you have to get EVE online again (for approximately 30minutes) to receive a new token.

5 EVE-NG Professional Update & Upgrade

⚠️ **Prerequisites: Internet access and working DNS on your EVE-NG is required.**

Verify your internet reachability with named ping. Example: ping www.google.com

```
ping www.google.com
```

```
root@eve-ng:~# ping www.google.com
PING www.google.com (216.58.207.228) 56(84) bytes of data:
64 bytes from arn09s19-in-f4.1e100.net (216.58.207.228): icmp_seq=1 ttl=58 time=9.11 ms
64 bytes from arn09s19-in-f4.1e100.net (216.58.207.228): icmp_seq=2 ttl=58 time=19.5 ms
64 bytes from arn09s19-in-f4.1e100.net (216.58.207.228): icmp_seq=3 ttl=58 time=9.50 ms
64 bytes from arn09s19-in-f4.1e100.net (216.58.207.228): icmp_seq=4 ttl=58 time=9.56 ms
64 bytes from arn09s19-in-f4.1e100.net (216.58.207.228): icmp_seq=5 ttl=58 time=9.56 ms
```

If your ping is success, follow next step for update. If named ping has no success, please verify your DNS IP assigned for EVE or firewall. Some cases ping can be blocked by FW, but Internet and DNS are capable to make update/upgrade.

OPTION for bare EVE installations which has **bnx2x Broadcom Ethernet** drivers, please rewrite your driver to the newest linux-firmware:

```
sudo apt-get -o Dpkg::Options::="--force-overwrite" install linux-firmware
```

5.1 EVE-NG Professional Update

It is strongly recommended to keep your EVE-NG up to date. To update and upgrade, SSH to your EVE CLI.

To verify your current EVE-NG version, please follow “CLI diagnostic information display commands” in section **16.1.1**. You can verify your current EVE version from the System/System Status tab on the top menu of the WEB GUI as well.

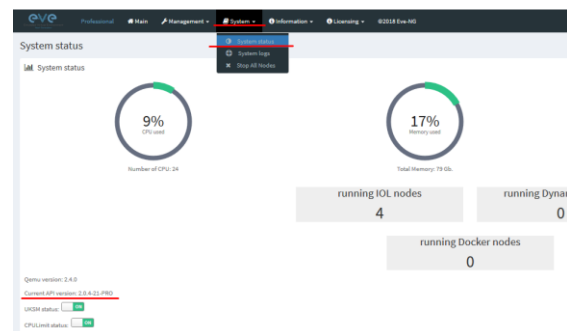

The newest version of EVE-NG can be verified by checking the official website: <http://www.eve-ng.net>. For update to the newest EVE-NG Professional version please follow the steps <https://www.eve-ng.net/index.php/1845-2/>

The year 2019 Major release, EVE Professional Edition: 2.0.6 – 17 (28 November, 2019)
To Update and Upgrade your EVE-NG Professional to the newest version, please follow the steps in the [Upgrade section \(reboot required\)](#)

Release 2.0.6-17 notes:

IMPORTANT NOTE: !!! Before this upgrade please stop all running labs and nodes !!!

- Important security update
- New HTML5 Console engine Guacamole 1.0
- HTML5 console background color change option

Bugfixe(s):

- Native console login fix

Type the below commands followed by Enter

```
apt update
```

In case the prompt asks to confirm with Y/N, answer Yes.

5.2 EVE-NG Professional Upgrade

IMPORTANT NOTE: Make sure you have stopped all your running labs. All nodes in the EVE must be stopped before upgrade!

For upgrade to the newest EVE-NG Professional version please follow the steps <https://www.eve-ng.net/index.php/1845-2/>

Type commands followed by Enter

```
apt upgrade
```

In case the prompt asks to confirm with Y/N, answer Yes.

! IMPORTANT NOTE: If you are upgrading EVE PRO from older version, the installation may ask you to confirm additional! Information:

```
Configuration file '/etc/issue'
==> Modified (by you or by a script) since installation.
==> Package distributor has shipped an updated version.
What would you like to do about it? Your options are:
  Y or I : install the package maintainer's version
  N or O : keep your currently-installed version
  D      : show the differences between the versions
  Z      : start a shell to examine the situation
The default action is to keep your current version.
*** issue (Y/I/N/O/D/Z) [default=N] ? _
Progress: [ 0%] [.....]
```

Answer for prompt above is “N”

```
Configuring grub-pc
A new version (/tmp/grub.tj7zRCnt3z) of configuration file /etc/default/grub is available,
but the version installed currently has been locally modified.

What do you want to do about modified configuration file grub?

install the package maintainer's version
keep the local version currently installed
show the differences between the versions
show a side-by-side difference between the versions
show a 3-way difference between available versions
do a 3-way merge between available versions (experimental)
start a new shell to examine the situation

<Ok>
```

Answer for grub-pc version is: **“Keep the local version currently installed”**

After the completion of the update and upgrade, reboot your EVE Server. Type the following command and hit enter.

```
reboot
```

⚠ IMPORTANT NOTE: Do NOT make EVE updates or upgrades from within the HTML5 Desktop console!

6 Types of EVE management consoles

⚠ IMPORTANT NOTE: EVE Console TCP ports. EVE Pro uses a dynamic port range between 1-65000. Dynamic means that every time you start a node on the lab, EVE assigns any free port from this range for Telnet, VNC or RDP access. Static TCP port assignment for Telnet sessions is not available in EVE PRO.

EVE Pro supports three different console types.

6.1 Native console



EVE Native console option requires locally installed software to access your lab nodes. To use the Native console option, you must have Administrator rights on your PC and ensure the TCP port range 1-65000 is not blocked by a firewall or antivirus software.

6.1.1 Native Console: telnet

Windows OS: You can use your preferred telnet program like Putty, SecureCRT or others. Example: Putty as native telnet client on Windows. To setup Windows native telnet client please follow section [3.6.1](#)

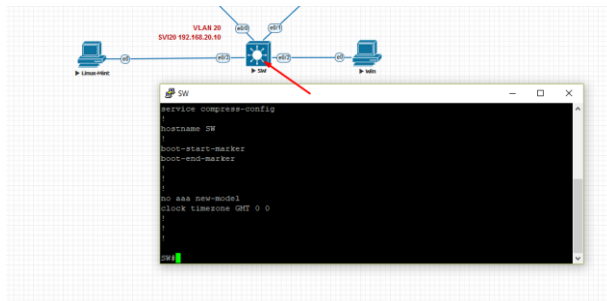

Linux OS: You can use your preferred telnet program like the Native Terminal, SecureCRT, or others. Example: Telnet client from the native terminal on Linux Mint. To setup Linux native telnet client please follow section [3.6.2](#)

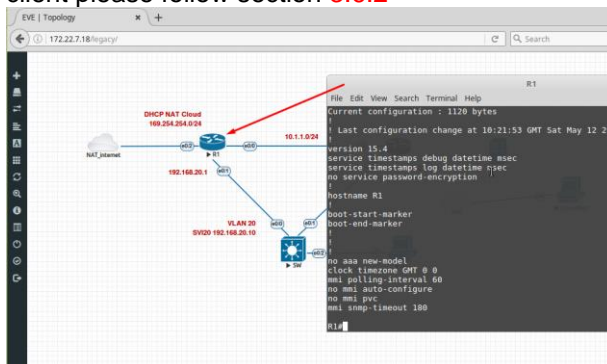

MAC OSX: You can use your preferred telnet program like the native Terminal, SecureCRT, or others.

Example: Telnet client from the native terminal on MAC OSX. To setup MAC OSX native telnet client please follow section [3.6.3](#)

6.1.2 Native Console: Wireshark

EVE Professional has an integrated Wireshark Docker station. This allows live captures without having Wireshark installed on the client machine. The EVE Capture console uses an integrated HTML session.

Right click on the node you wish to capture, choose capture and the interface. Capture Session will open in a new browser window.

EVE-PRO supports packet captures on ethernet and serial interfaces.

Select the interface frame type which will be captured:

- Ethernet for Ethernet, Fast Ethernet, Gigabit Ethernet.
- Serial interface frames: HDLC, PPP or Frame Relay.

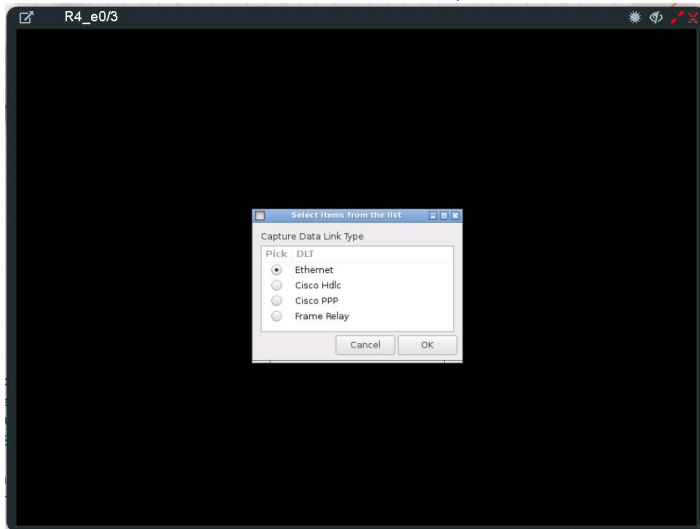

Integrated HTML RDP for Wireshark capture

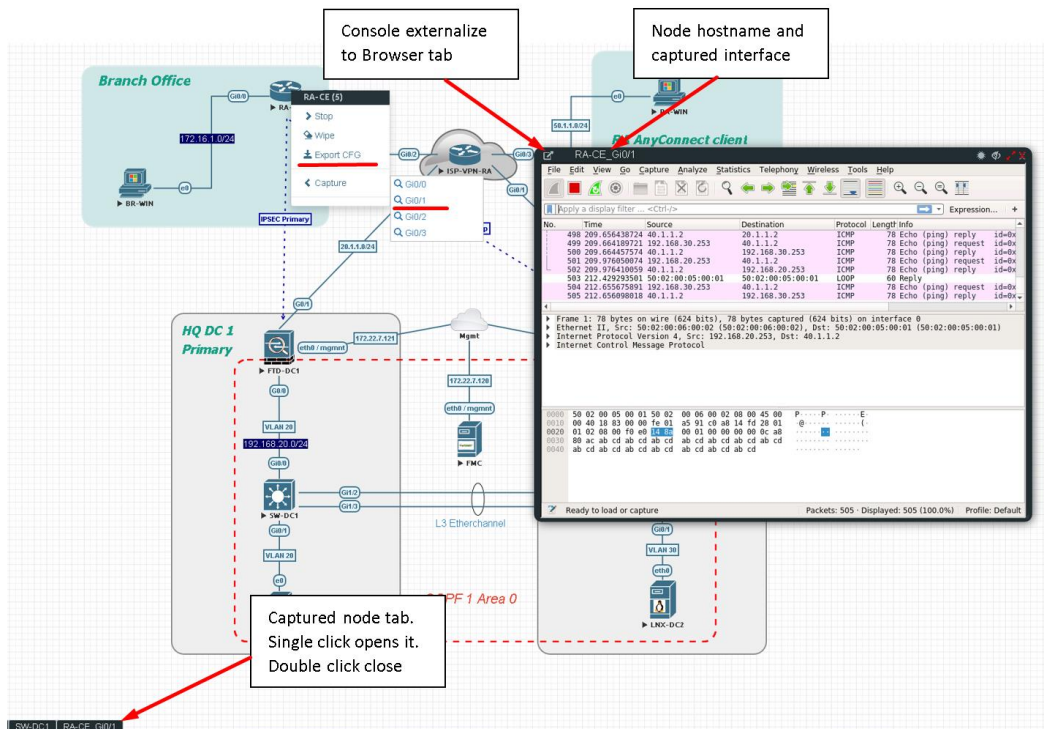

Example: RA-CE live interface G0/1 capture.

To save the captured file on your local PC, please refer to section 12.1

6.1.3 Native Console: VNC

Windows OS: Recommended and tested is UltraVNC but any other compatible one can be used.

Example: UltraVNC as Native VNC client on Windows. To setup Windows native VNC client please follow section 3.6.1

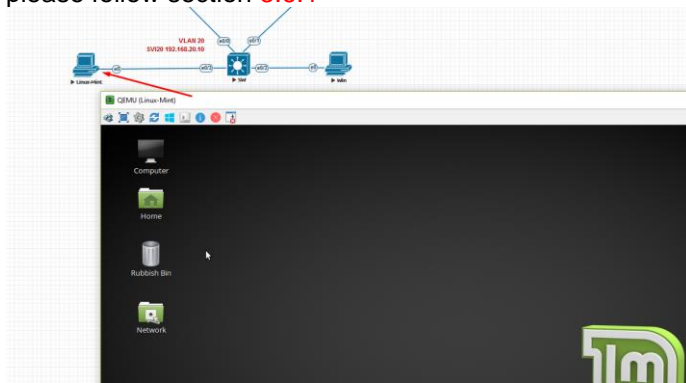

Linux OS: Remote Desktop Viewer for VNC Sessions.

Example: Remote Desktop Viewer for VNC sessions on Linux Mint. To setup Linux native Remote Desktop Viewer please follow section 3.6.2

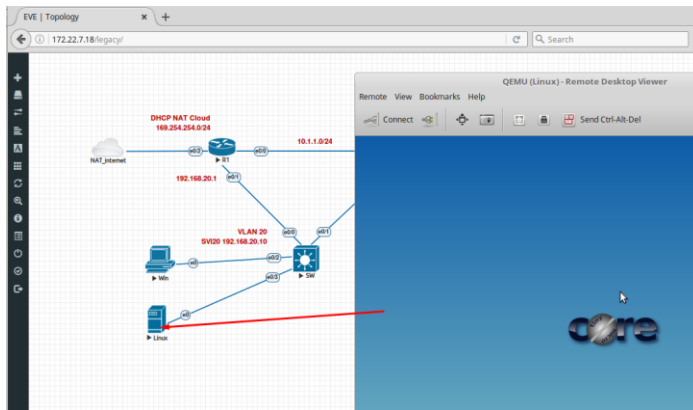

MAC OSX: Preferred VNC program: Chicken VNC
Example: Chicken VNC as Native VNC client on MAC OSX. To setup MAC OSX native RDP Viewer client please follow section [3.6.3](#)

6.1.4 Native Console: RDP

Windows OS: Windows Native RDP.
Example: Windows RDP session to Win10 host in the lab.

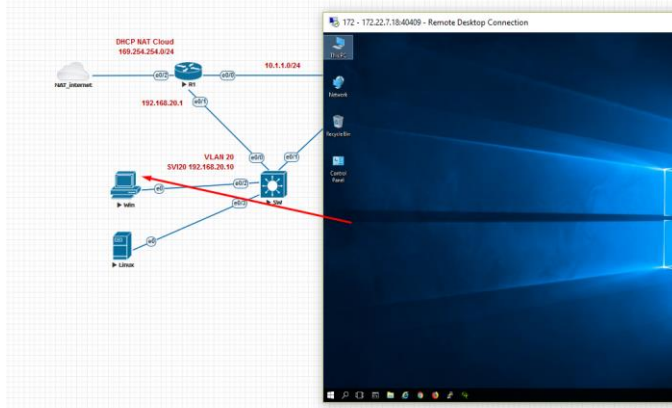

Linux OS: Remote Desktop Viewer as RDP session to lab Win10 host.
Example: RDP session to Win10 host in the lab. To setup Linux native Remote Desktop Viewer please follow section [3.6.2](#)

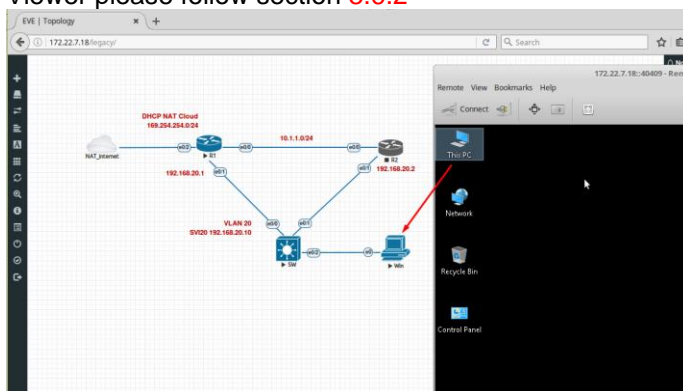

MAC OSX: Remote Desktop Viewer as RDP session to lab Win10 host.
Example: RDP session to Win10 host in the lab.
To setup MAC OSX native RDP Viewer client please follow section [3.6.3](#)

6.2 HTML5 console

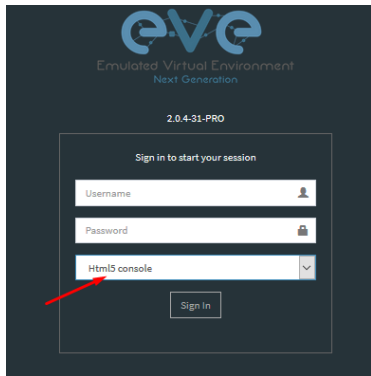

The EVE PRO HTML5 console provides a clientless solution for managing labs and node sessions. Management is achieved directly through the browser by using the Apache Guacamole HTML5 Engine. It is very convenient for Corporate users with restricted Workstation permissions (Locked Telnet, vnc, rdp).

6.2.1 HTML5 Console window functions

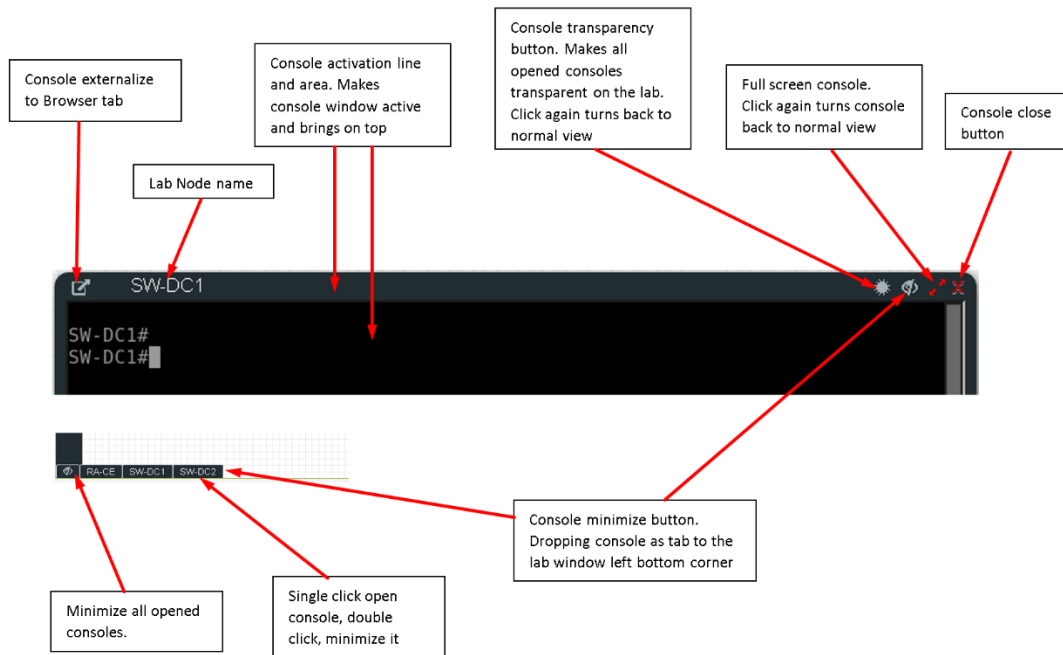

6.2.2 HTML5 Console: Telnet

HTML5 Telnet console is integrated and opens telnet sessions in the browser.

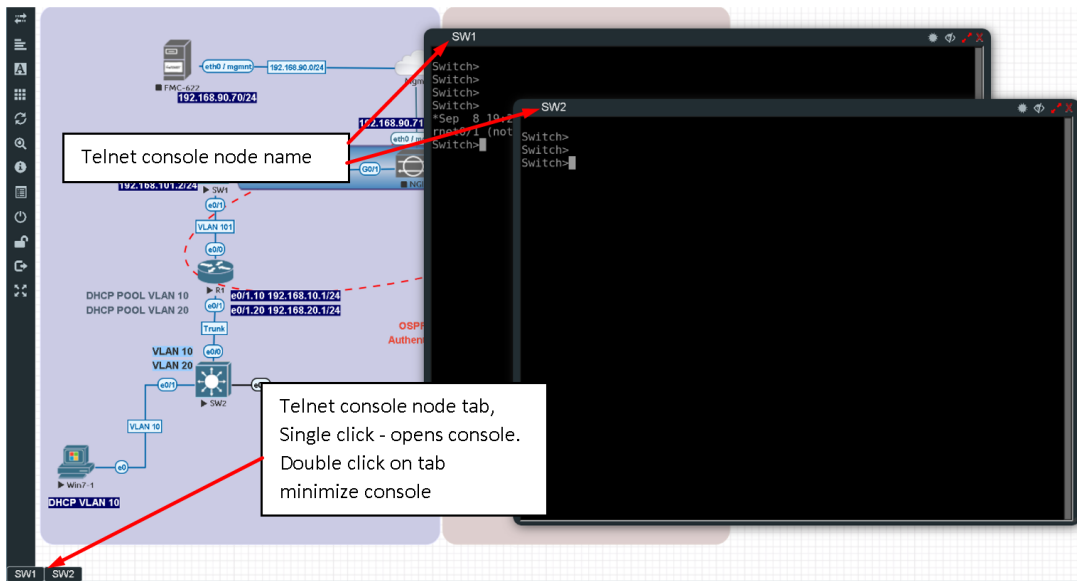

Option: The new Chrome v70.0.3538.110 and higher allows the use of the copy/paste function inside the HTML session. Type in your Chrome browser “<chrome://settings/content/clipboard>” and press **Add** to allow the use of the clipboard extension for your EVE Server: https://your_ip:443

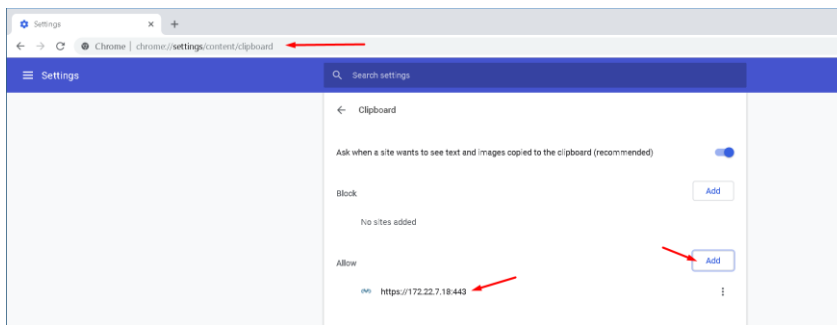

Option: The new Firefox v63.0.3 and higher allows the use of the copy/paste function inside the HTML session. Type in your Firefox browser “<about:config>” and enable clipboard values below:

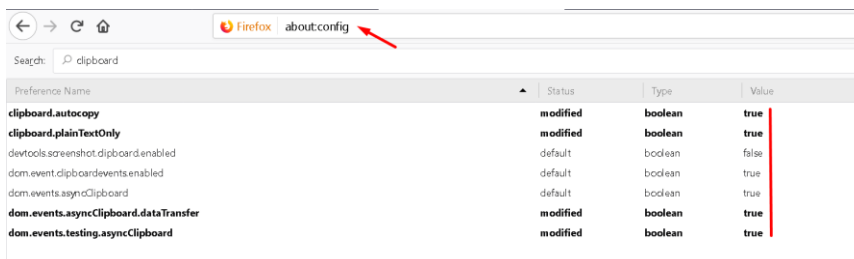

6.2.3 HTML5 Console: Wireshark

Right click on the node you wish to capture, choose capture and the interface. Capture Session will open in a new browser window.

EVE-PRO supports packet captures on ethernet and serial interfaces.
Select the interface frame type which will be captured:

- Ethernet for Ethernet, Fast Ethernet, Gigabit Ethernet.
- Serial interface frames: HDLC, PPP or Frame Relay.

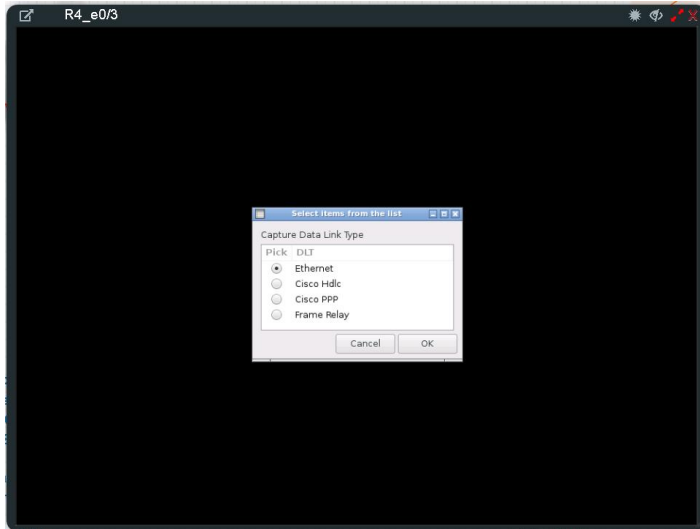

No.	Time	Source	Destination	Protocol	Length	Info
498	209.656438724	40.1.1.2	20.1.1.2	ICMP	78	Echo (ping) reply id=0x
499	209.664189723	192.168.30.253	40.1.1.2	ICMP	78	Echo (ping) request id=0x
500	209.664457574	40.1.1.2	192.168.30.253	ICMP	78	Echo (ping) reply id=0x
501	209.976959874	192.168.20.253	40.1.1.2	ICMP	78	Echo (ping) request id=0x
502	209.976418659	40.1.1.2	192.168.20.253	ICMP	78	Echo (ping) reply id=0x
503	212.42929501	50:02:00:05:00:01	50:02:00:05:00:01	LOOP	60	Reply
504	212.655675891	192.168.30.253	40.1.1.2	ICMP	78	Echo (ping) request id=0x
505	212.656988018	40.1.1.2	192.168.30.253	ICMP	78	Echo (ping) reply id=0x

To save captured file to your local PC, please refer section [12.2](#)

6.2.4 HTML5 Console: VNC

HTML5 VNC console is integrated and opens VNC sessions in the browser.

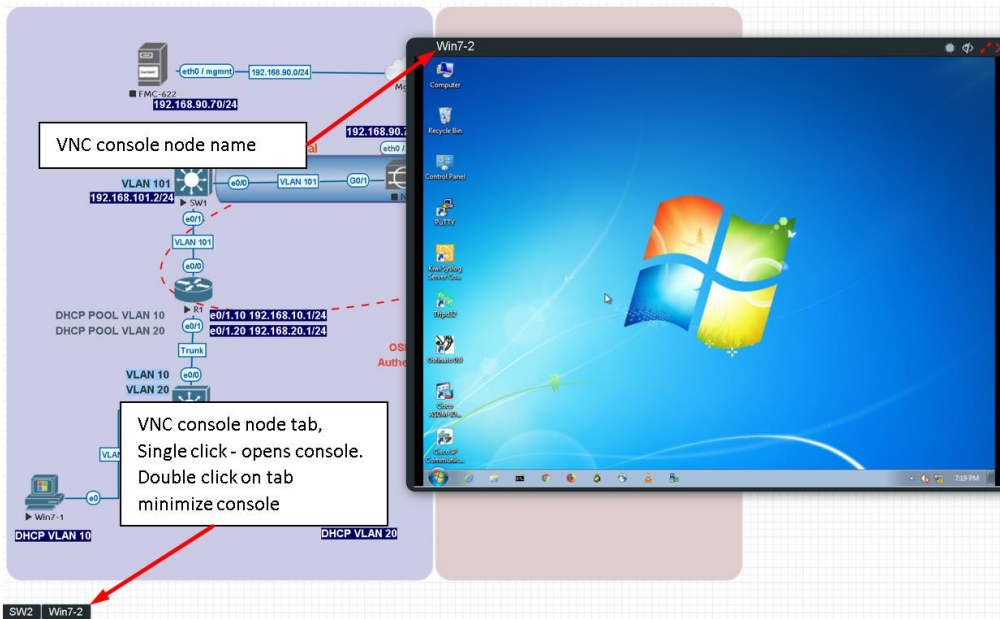

6.2.5 HTML5 Console: RDP

HTML5 RDP console is integrated and opens RDP sessions in the browser. For Windows 7, 8, 10, Windows Server 2012, 2016 please mind the note below.

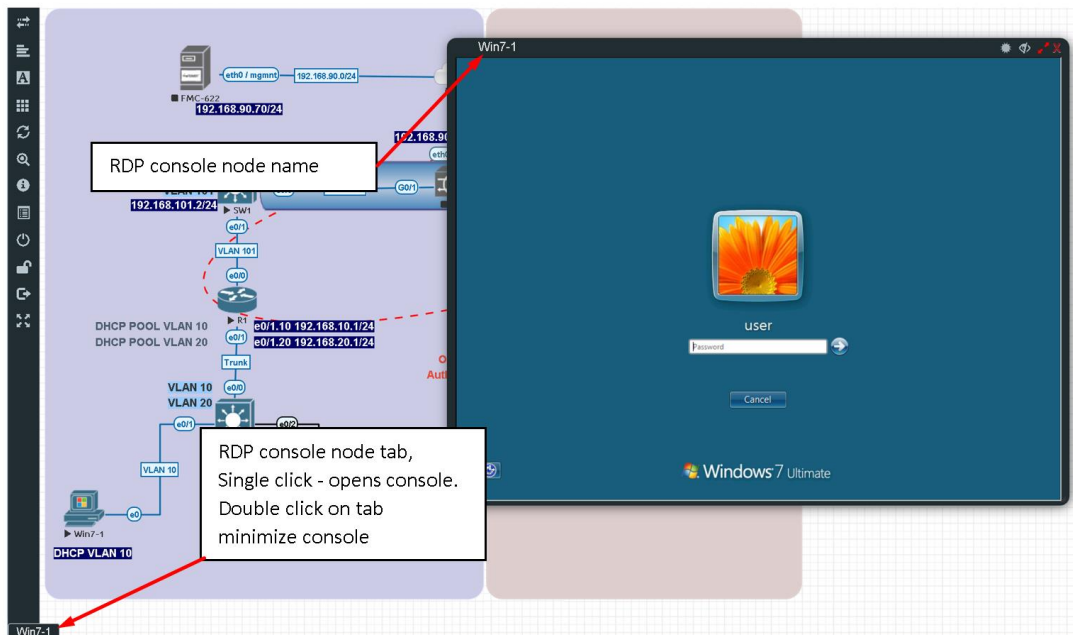

⚠ IMPORTANT NOTE: For all Windows nodes, the console type must be set to **RDP-TLS** in the node template. RDP-TLS node console option is actually only used with HTML5 RDP sessions.

The username and the password can be configured in the node edit settings. This will allow you to resize HTML RDP console without re-login in the windows host.

Example below, Edit node, Win10, Console type rdp-tls, username: user and password: Test123

EDIT NODE

Template
Windows

ID
7

Image
win-10-x86-20H2v3

Name/prefix
HQ-PC

Icon
Desktop2.png

UUID
2c938db1-a889-4d70-ac4b-17ab622e74c6

CPU Limit

CPU	RAM (MB)	Ethernets
2	4096	1

First Eth MAC Address
50:0a:00:07:00:00

QEMU Version	QEMU Arch	QEMU Nic
4.1.0	x86_64	tpl(e1000)

QEMU custom options
-machine type=pc,accel=kvm -cpu host,+pcid,+kvm_pv_unhalt,+kvm_pv_eoi,hv_sf

Startup configuration	Satellite
None	sat1

Delay (s)
0

Console
rdp-tls

RDP Username
user

RDP Password
Test123

Left	Top
60	573

Save **Cancel**

6.3 HTML5 Desktop console



EVE PRO HTML5 Desktop provides a full-featured clientless solution for managing labs and node sessions. Management is achieved directly through the browser by using an integrated docker desktop that is accessed through the Apache Guacamole HTML5 Engine. The docker contains a full featured Linux desktop and is very convenient for corporate users with restricted workstation rights (locked telnet, vnc, rdp).

6.3.1 Login to HTML5 Desktop console

Step 1: On your first login to the EVE HTML5-Desktop console, EVE will open a new HTML window session to an integrated Docker management station. On the Desktop you will see another EVE login icon.

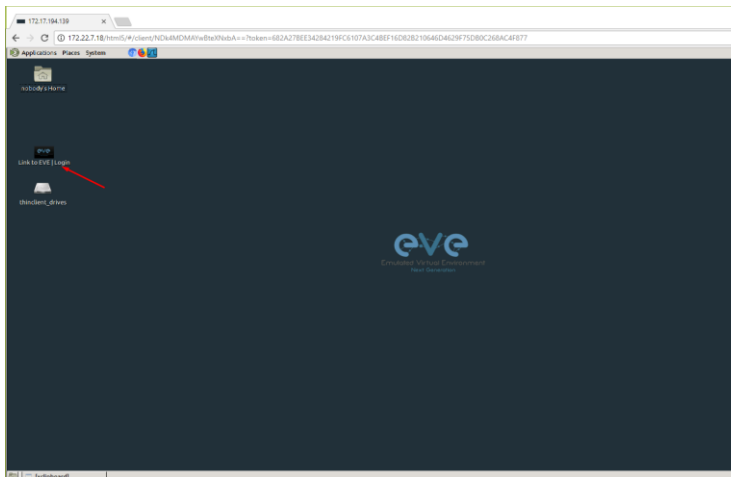

Step 2: Double-click the “Link to EVE | Login” icon and log into EVE using **NATIVE** console.

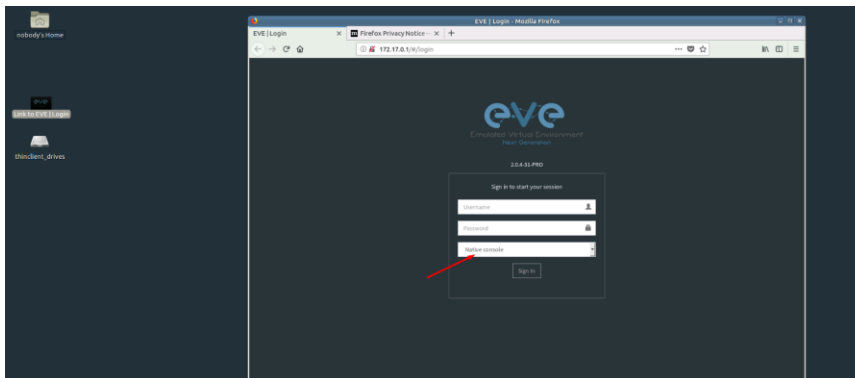

Inside of the integrated docker station, it will open another session to EVE. All features inside of the Docker Desktop will work as you are used to with the Native console.

6.3.2 HTML5 Desktop Console: telnet

The integrated management docker station telnet client allows you to telnet to nodes. Telnet sessions are in a tabbed style as shown below.

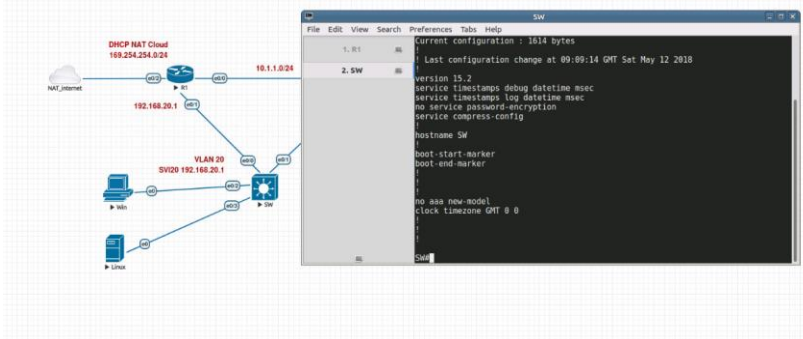

6.3.3 HTML5 Desktop Console: Wireshark

Right click on the node you wish to capture, choose capture and select the relevant interface. The capture will open in an RDP session window.

EVE-PRO supports packet captures on ethernet and serial interfaces. Select the interface frame type which will be captured:

- Ethernet for Ethernet, Fast Ethernet, Gigabit Ethernet.
- Serial interface frames: HDLC, PPP or Frame Relay.

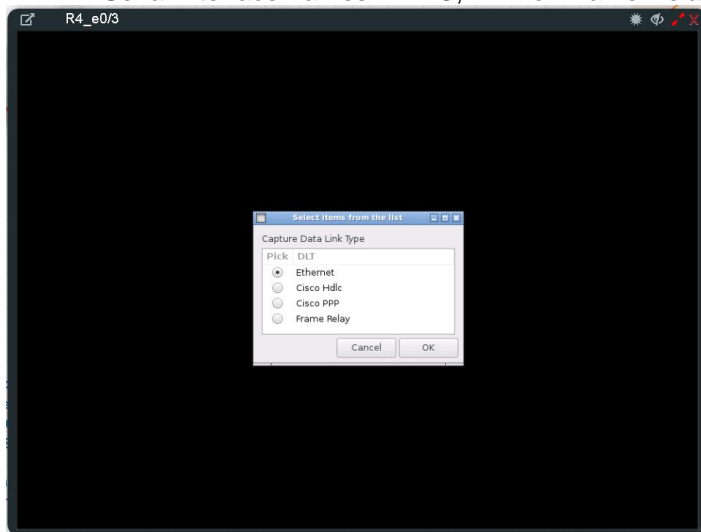

The integrated management docker station Wireshark client allows you to capture and save captured files onto the docker station. For instructions on how to save files to your local PC, please refer to section [12.3](#)

7 EVE WEB GUI Management

7.1 EVE Management Page



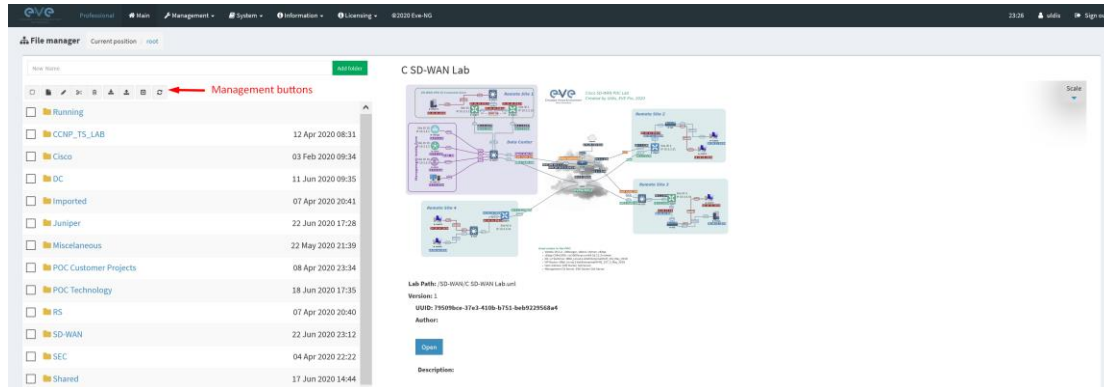



The Main EVE management window





The lab preview actual picture appears after 3-5 seconds.

7.1.1 Management buttons









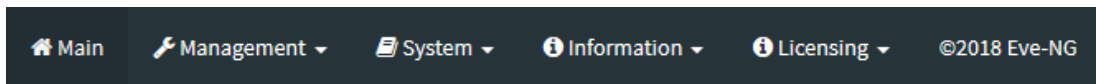

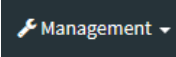
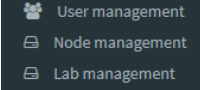
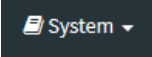
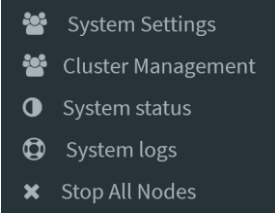
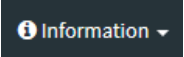
Button	Description
	Select All or Deselect All folders or labs in the EVE tree
	Create/Add new Lab
	Change selected item name. To use this option, please select the folder or lab that you want to rename. You must not rename the Shared folder, the Users folder or any folder inside the Users folder.
	Move selected item(s) to a different location. To use this option, please select the folder(s) or lab(s) that you want to move.
	Delete selected folders or labs. You must not delete the Shared folder, the Users folder or any folder inside the Users folder.
	Import an EVE lab or lab folder from a previous export. Import file must be in .zip format

	Export EVE lab or folder. Select folder(s) and/or labs you wish to export and select this option. The export is saved to your local PC in .zip format and is ready to import to another EVE.
	Toggle the sorting folders and labs between alphabetical and last edit date (ascending/descending cannot be changed currently).
	Refresh current folder content

7.1.2 Management tabs



Tab	Description
	Returns back to the EVE Home Management screen.
 	Management dropdown, opening the management submenu. Management submenu, refer to sections: 7.3 , 7.3.2 , 7.3.3
 	System dropdown. System submenu, refer to section 7.4
	Information dropdown Information submenu, for details see section 7.5

<ul style="list-style-type: none">  About  Forum  YouTube Channel  Help on EVE-NG LiveChat 	
<div data-bbox="252 465 411 533" style="background-color: #333; color: white; padding: 5px; margin-bottom: 10px;">  Licensing ▾ </div> <div data-bbox="252 562 512 685" style="background-color: #333; color: white; padding: 5px;"> <ul style="list-style-type: none">  License Information  License Request  License Upload </div>	<p>Licensing dropdown</p> <p>Licensing management, please see section 4</p>

7.2 Folders and Lab files management

This section will explain how to manage folders and labs on the EVE management page.

7.2.1 Folders Management

EVE Professional has three default folders used for various operations. These must not be deleted or renamed (see below).

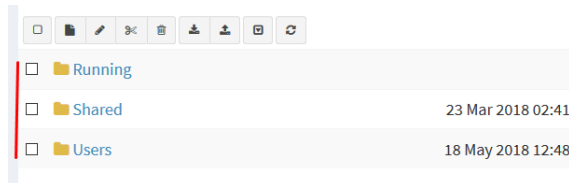

- Admins can create additional folders for any user.
- Editors can create or manage folders in their own profile/folder or within the Shared folder

7.2.1.1 Default folder Running

EVE professional allows a single user to run multiple labs and switch between them with the Running folder.

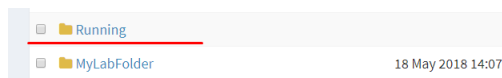

Example:

- Start a lab and close it
- Open and start another lab and close it

When you open your Running folder, you will see both running labs in it. It is easy to switch between labs.

The example below is showing two running labs in the Running folder.

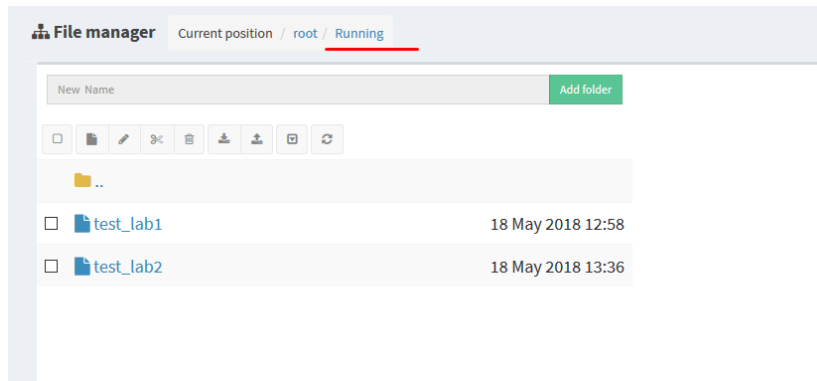

7.2.1.2 Default folder Shared

To manage the Shared folder an **Admin or Editor** user account is required.

The EVE Professional Shared folder is visible to all EVE users. Admin and Editor Accounts can create folders or labs and place them into the Shared folder.

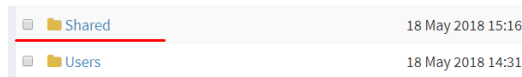

Example: An Admin creates a lab and places it into the Shared folder.

Step 1: Create a lab, refer to section 9.1

Step 2: Select the lab you wish to move to the Shared folder and press **Move to** (or create it in the Shared folder from the start).

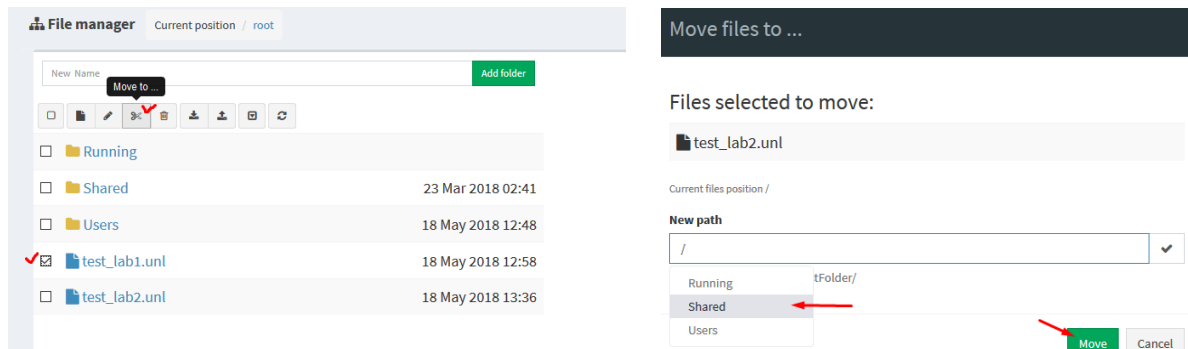

Step 3: Another user account can use the lab placed by the Admin in the Shared folder

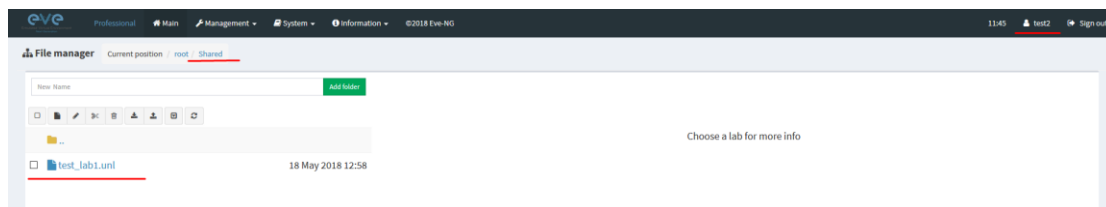

⚠ NOTE: Every user has its own profile; this means that every user has an independent Running folder where this lab runs independently from other users.

⚠ NOTE: Labs can be created and modified (e.g. settings and preconfigs) by an Admin or an Editor user. The User role can use the lab only exactly the way it was configured by an Admin or Editor and is unable to change any settings.

⚠ NOTE: Admins and Editors can create folders and labs inside the Shared directory

7.2.1.3 Default folder Users

To manage the Users folder, an **Admin** user account is required.

The Users directory is a default EVE folder where Editors and Users have their personal folders stored.

myLabFolder	18 May 2018 14:07
Shared	18 May 2018 15:16
Users	18 May 2018 14:31

Once an Admin has created a new Editor or User account, EVE will automatically create a folder with the user login name under the default directory Users.

Example: Below you can see the folders for the users with the following login names: **test2**, **test3** and **test4**

File manager		Current position / root / Users
New Name <input type="text"/> Add folder		
<input type="checkbox"/> <input type="checkbox"/> <input type="checkbox"/> <input type="checkbox"/> <input type="checkbox"/> <input type="checkbox"/> <input type="checkbox"/> <input type="checkbox"/>		
..		
<input type="checkbox"/>	test2	18 May 2018 14:30
<input type="checkbox"/>	test3	18 May 2018 14:29
<input type="checkbox"/>	test4	18 May 2018 14:31

⚠ NOTE: An Admin can manage any user's folder or place labs in it.

7.2.1.4 Create folder

An **Admin** or **Editor** user account is required.

Type the new folder name and click "Add Folder"

⚠ NOTE: Editors can only create folders within their own profile folder or in the Shared folder

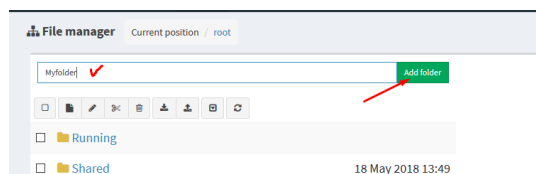

7.2.1.5 Delete folder

An **Admin** or **Editor** user account is required.

Select the folder you wish to delete and press Delete.

⚠ NOTE: All folder content will be deleted as well.

⚠ NOTE: Editors can only manage their own or the Shared folder

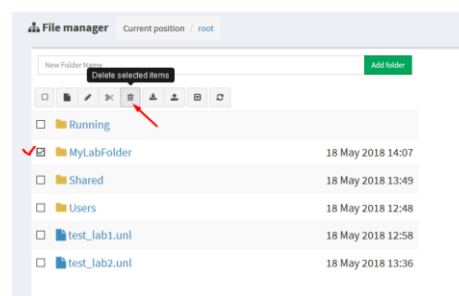

7.2.1.6 Move Folder

An **Admin or Editor** user account is required.

Select the folder you wish to move and press the Move to button.

⚠ NOTE: Editors can only manage their own or the Shared folder

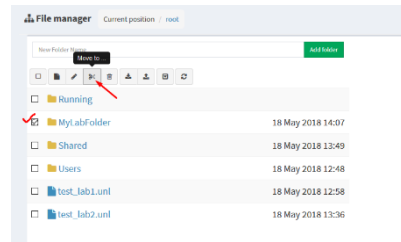

Select the target destination for your folder and confirm by clicking on Move.

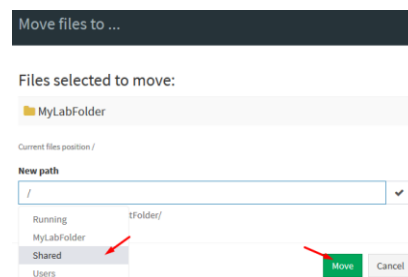

7.2.1.7 Export Folder

Select the folder(s) you wish to export from your EVE and press Export.

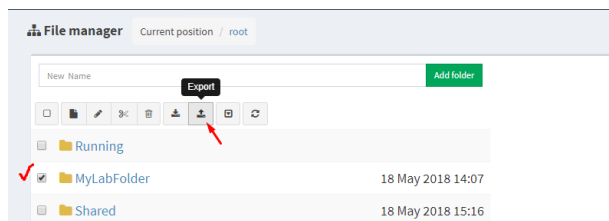

Save the exported file as .zip to your local PC. The exported zip file is ready to import to another EVE instance.

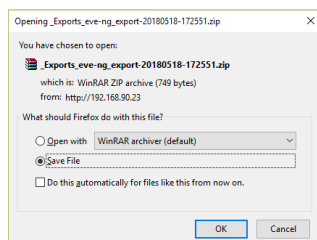

If your browser is set to save downloaded files to a default directory, your exported file will be saved in the browsers default downloads directory.

7.2.1.8 Import Folder

⚠ IMPORTANT: Importable file **MUST** be in .zip format, do **NOT** unzip the file.

Step 1: Press the Import button.

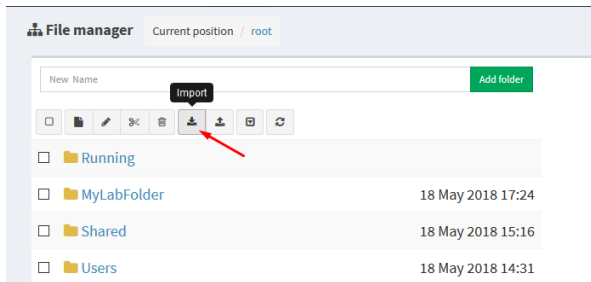

Step 2: Choose the zipped file that contains EVE folders with labs.

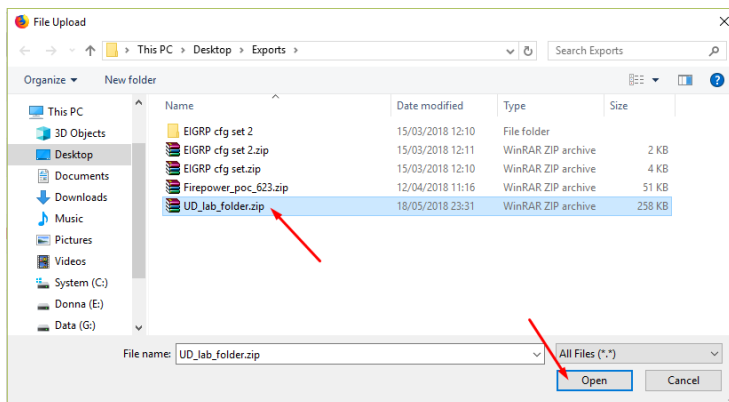

Step 3: Press the Upload Button

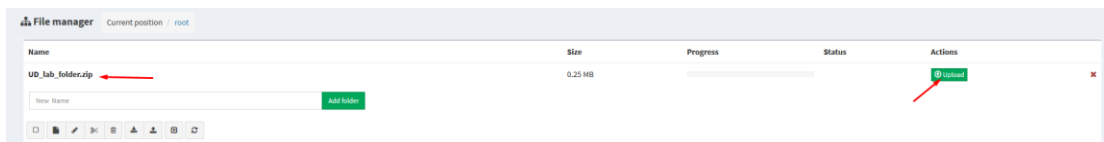

Step 4: After you made sure your folder is imported and has all its content (labs), you can close the upload session.

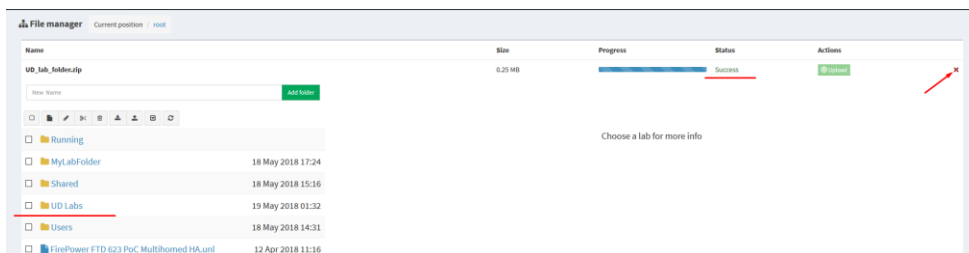

7.2.2 Lab files Management

You can manage created labs from the main EVE file manager window

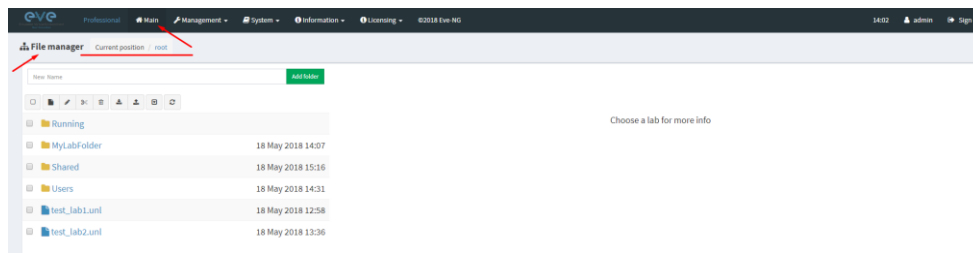

7.2.2.1 Create Lab

The **Admin or Editor** user account is required.

! NOTE: An Editor can create labs only within his personal folder or in the Shared folder

Click on the New Lab button and refer to section [9.1](#)

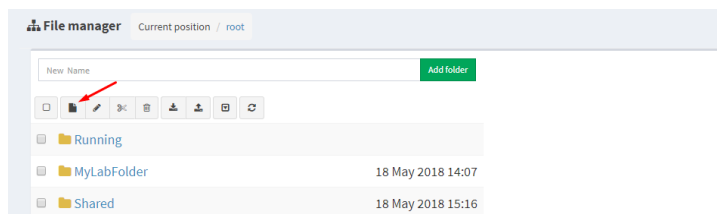

7.2.2.2 Delete Lab

The **Admin or Editor** user account is required to delete labs.

! NOTE: An Editor can delete labs only within his personal folder or in the Shared folder

Step 1: Select the lab or labs you wish to delete and then press the Delete button

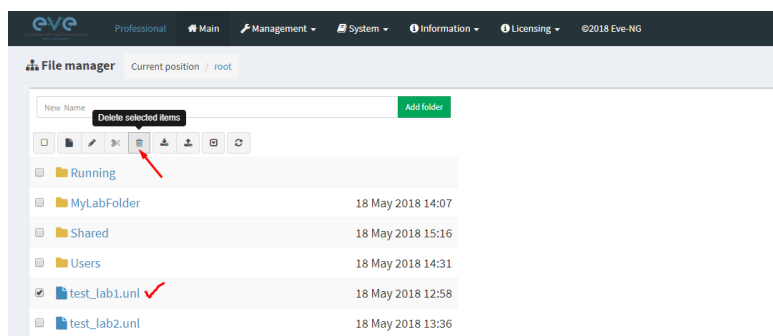

7.2.2.3 Clone Lab

The **Admin or Editor** user account is required to clone labs.

! NOTE: An Editor can create labs only within his personal folder or in the Shared folder

The cloning feature provides a very convenient way to duplicate original labs to share with others or base another lab on it.

Cloned labs will copy exported configs (on supported nodes) but will not copy saved states/configurations in Qemu nodes like Windows hosts, Cisco ISE, or other Qemu nodes that

are not supported by the export config feature. Please refer to section **11.3** for more information on configuration export for labs.

Step 1: Select the lab you wish to clone and move the mouse pointer (blue) to that lab, an extra option will appear. Click on Clone.

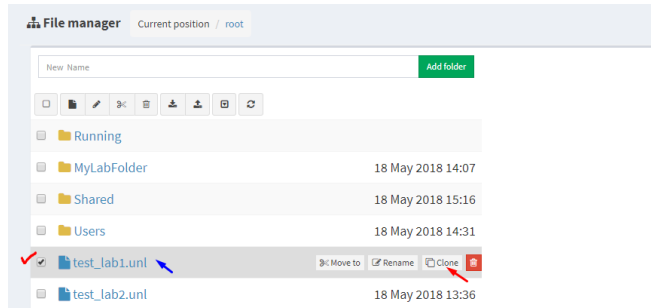

Step 2: Your lab will be cloned with all your exported configurations or configuration sets with a new name.

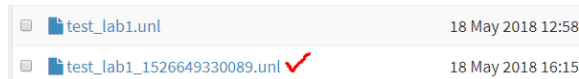

Step 3: The lab has been cloned lab and can be renamed to your liking. Move the mouse pointer to the cloned lab and choose Rename.



Step 4: Rename it, and click OK to confirm

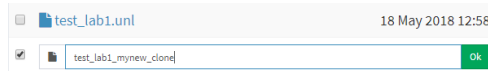

7.2.2.4 Move Lab

The **Admin** or **Editor** user account is required to move labs.

⚠ NOTE: An Editor can create labs only within his personal folder or in the Shared folder

Step 1: Select the lab you wish to Move and move the mouse pointer (blue) to that lab, an extra option will appear. Choose Move to.



Step 2: Choose the path to the new destination and confirm by clicking Move

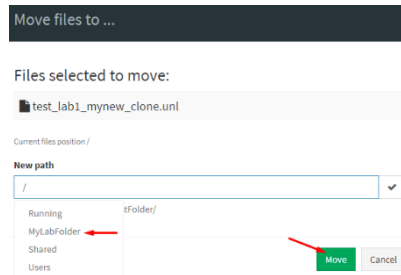

7.2.2.5 Export Lab

Select the Lab(s) you wish to export from your EVE Server and press Export.

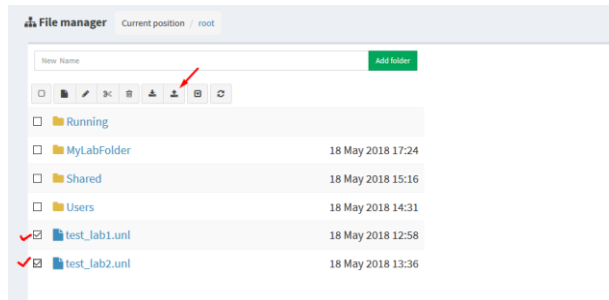

Save exported file as .zip to your local PC. The exported zip file is ready to import into another EVE.

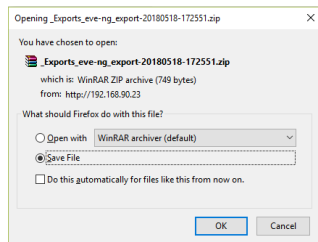

If your browser is set to save downloaded files to default directory, your exported file will be saved in the browsers default downloads directory.

7.2.2.6 Import Labs

⚠ IMPORTANT: Importable file MUST be in .zip format, do NOT unzip the file.

Step 1: Press the Import button.

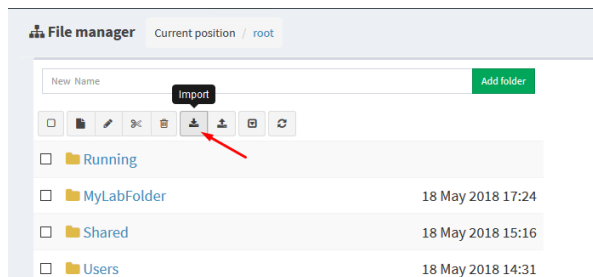

Step 2: Choose the zipped file which contains the EVE labs.

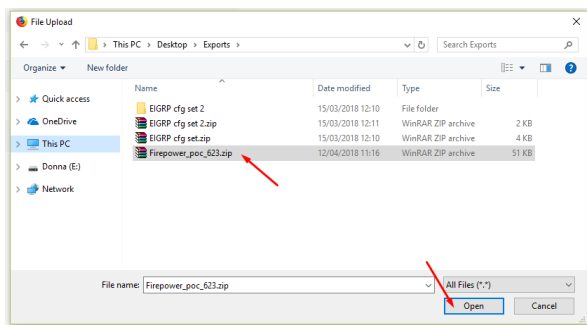

Step 3: Press the Upload Button

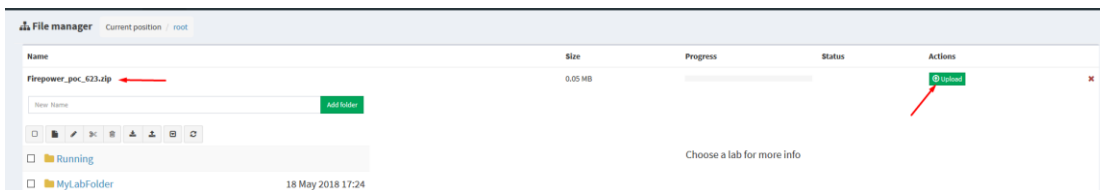

Step 4: After you made sure your lab is imported, you can close the upload session.

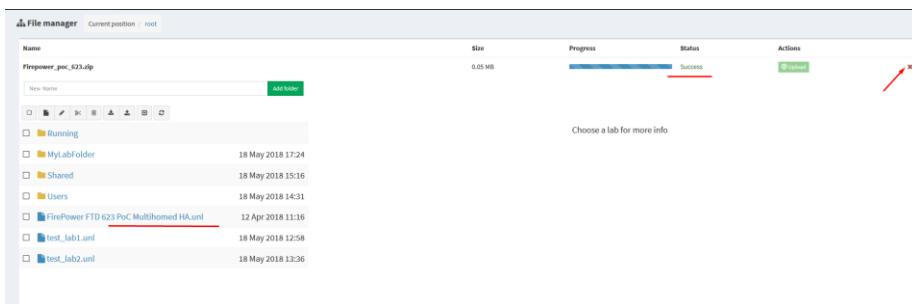

7.3 EVE Management Dropdown Menu

7.3.1 EVE User management

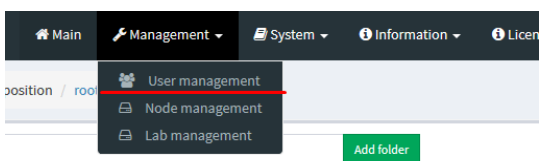

The User Management page, under the Management dropdown, will allow Admin accounts to manage other user accounts.

⚠ Only the **Admin** role is allowed to create or edit user accounts.

7.3.1.1 Creating a new EVE User

Step 1: Open the User management submenu. Management>User management and click Add user

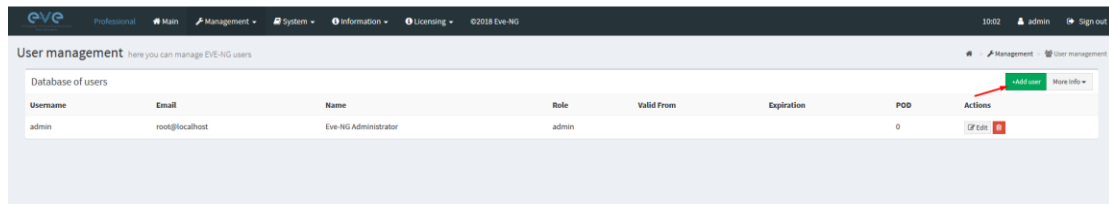

Step 2: The Add New User management window will pop up. Fill in the main information about your EVE user

Add New User

User Name*

Use only [A-Za-z0-9_-.@]chars

Authentication

Password

Password Confirmation

Email

Please enter a valid email

Name

Role

Console

Satellite

Account Validity

From **to**

POD*

Quotas

CPU **RAM (GB)**

* - Required Fields

Step 3: If your user will be Radius authenticated, please Select Radius from Authentication menu. Passwords will be striped off, because authenticator will look Radius server for user password. How to setup radius server IP and Shared secret please follow Section: **17.1**

Add New User

User Name*
testuser
Use only [A-Za-z0-9_-@]chars

Authentication radius

Password
.....

Password Confirmation
.....

Step 4: If your user will be Active Directory (LDAP) authenticated, please enable Active Directory from Authentication Menu. Passwords will be striped off, because authenticator will look Active Directory server for user password. How to Active Directory server IP please follow

NOTE: Username for Active Director must contain domain at the end of username. Example: **labuser@eve.lab**

Add New User

User Name*
labuser@eve.lab
Use only [A-Za-z0-9_-@]chars

Authentication active directory

Password
.....

Password Confirmation
.....

Step 5: If you have bought other EVE licenses, you can choose the preferred user role. For licensing and user roles please refer to section **4**

Name
John Tester

Role Administrator
Administrator
Editor

Acco
From User 0 to -1 0

POD*
1

Step 6: Set the Console type for the user. If Console type is set exact: Native, HTML or HTML5 Desktop, user after login in the EVE will be forced to use selected Console Type. If Console Type is set to "any", user is able to choose Console type on Login page which Console will be used.

Role

Console

Lab

Satellite

html5

Desktop

Step 7: **Sticky Lab**. Applies for User role only. Set the specific Lab for the user “sticky lab”. After login in the EVE User will directed only to this lab. He cannot close the lab to get in main Lab management page. User can Start/Stop/Wipe lab, as well save his lab work on the lab devices. Follow Section: [7.3.1.5](#)

Lab

Satellite

Account

From to

Step 8: Set the Cluster Satellite for the user. This applies for Editor and User roles. User will stick to selected Satellite. Editor or User will be forced to use only selected Satellite server.

If the value is set to “any”, Editor role can select or change Satellite on the lab himself. User role will use Satellites set by admin on the lab.

The value “any” is set y default.

Satellite

Account

From to

POD*

Step 9: Set the access date and time From - to. If the fields are left empty (untouched), your user will have no time restrictions for accessing the EVE Server. [Account validity with time settings is available for Editor and User roles only.](#)

- ⚠ Admin accounts have no time limit for account validity and resource, and Account Validity time or resource cannot be set.

Account Validity

From **to**

POD*

Quotas

CPU **RAM (GB)**

Step 10: The POD number is a value assigned to user accounts automatically. POD numbers are like user profiles inside of EVE and are a unique value for every user Think of PODs like a virtual rack of equipment for each user. Admins can assign a preferred number between 1-128. Please keep POD numbers unique between users!

Step 11: Set user limitation to use eve resources. “-1” value is unlimited EVE resource. Only Editor and User roles can be set for EVE resource limitation, Quota.

Example: editor user is allowed to run/create labs for x4 CPU and 8Gb RAM.

Quotas

CPU **RAM (GB)**

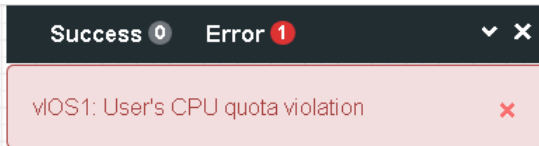

In case of violation these settings, user will receive alert message in the notification area:

Step 12: Press ADD



7.3.1.2 Edit EVE User

Step 1: Open the User management submenu. Management -> User management and choose which user you want to edit.

Username	Email	Name	Role	Valid From	Expiration	POD	Actions
admin	root@localhost	Eve-NG Administrator	admin			0	Of Edit
test	test@eve.lab	John Tester	user	2018-05-20 00:00	2018-05-20 18:00	1	Of Edit
Test2	test@eve.lab	Jenny Tester	editor	2018-05-19 00:00	2018-05-20 23:00	2	Of Edit

Step 2: The Edit user management window will pop up. Now you can edit necessary user information, roles, or access time. Confirm settings by pressing Edit at the bottom of the window.

Edit User

User Name*

editor

External Auth (Radius)

Password

.....

Password Confirmation

.....

Email

admin@eve-ng.net

Please enter a valid email

Name

Editor uldis

Use only [A-Za-z0-9_-] chars

Role Lab Editor

Console any

Satellite sat1

Account Validity

From **to**

POD*

2

Quotas

CPU **RAM (GB)**

* - Required Fields

Save

Cancel

7.3.1.3 User session termination

Administrator has rights to terminate active user session to the EVE server. Press Kick to disconnect user from EVE HTML session.

Username	Authenticator	Email	Name	Role	Disk Usage	Valid From	Expiration	Max CPU	Max RAM (GB)	POD	Actions
admin	Internal	admin@eve-ng.net	EVE Administrator	admin	0.01 GB			Unlimited	Unlimited	0	<input type="button" value="Kick"/> <input type="button" value="Logout"/> <input type="button" value="More (3)"/>

7.3.1.4 User monitoring

There is a dropdown menu next to “Add User” called “More Info” that can provide additional information about your users. Click the checkbox next to the relevant information that you would like displayed. Additional columns will be added for each checkbox that is chosen.

Username	Authenticator	Email	Name	Role	Disk Usage	Valid From	Expiration	Last session time	Last session ip	Current folder	Current lab	Checkboxes
assess1	radius	assess1@eve.lab	Asses User	user	0 GB	2018-11-22 05:30	2018-11-28 07:00	N/A	N/A	N/A	N/A	<input type="checkbox"/> Last session time <input type="checkbox"/> Last session ip <input type="checkbox"/> Current folder <input type="checkbox"/> Current lab
admin	internal	admin@eve-ng.net	Eve-NG Administrator	admin	1 GB			16 Nov 2018 9:26:34	172.22.30.101	/	N/A	<input type="checkbox"/> Last session time <input type="checkbox"/> Last session ip <input type="checkbox"/> Current folder <input type="checkbox"/> Current lab
admin2	radius	admin2@eve.lab	Admin2 User	admin	0 GB			N/A	N/A	N/A	N/A	<input type="checkbox"/> Last session time <input type="checkbox"/> Last session ip <input type="checkbox"/> Current folder <input type="checkbox"/> Current lab

7.3.1.5 User role sticky lab

Sticky Lab. Applies for User role only. Set the specific Lab for the user, “sticky lab”. After login in the WEB, EVE User will be directed only to this lab. He cannot close the lab to get in main Lab management page. User can Start/Stop/Wipe lab, as well save his lab work on the lab devices.

Pre-requisites for this feature: For Lab selection from the list, the Lab must be upload in the Shared folder by admin first. If Lab Menu is selected to “None”, User can close the Lab and open another shared Lab for him.

The value “None” is set as default.

Edit User

Lab: **None** (selected)

None
/Shared/A1.unl
/Shared/F SD-WAN Kids Lab.unl
/Shared/RS CCNP TS Lab_test.unl

User Name: stud01

External Auth (Radius)

Password: [masked]

Password Confirmation: [masked]

Email: stud01@eve.net

Name: Student 01

Role: Lab User

Console: html5

Lab: /Shared/RS CCNP TS Lab_test.unl

Satellite: sat1

Account Validity: From -1 to 0 to -1

Quotas: CPU -1, RAM (GB) -1

* - Required Fields

Buttons: Edit, Cancel

7.3.2 EVE Node management

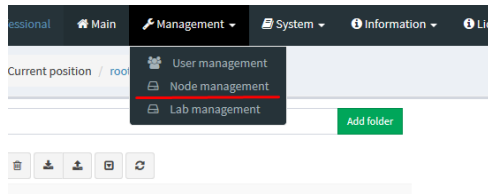

The Management dropdown has a submenu called “Node Management.” The Node management menu displays all currently running nodes within EVE. Within this menu, an Admin account can manage or even console to any user’s nodes.

⚠ **NOTE:** Editor and User accounts are able to see and open console sessions to their own running nodes only

⚠ **NOTE:** Admin accounts are able to see and open console session to all users running nodes

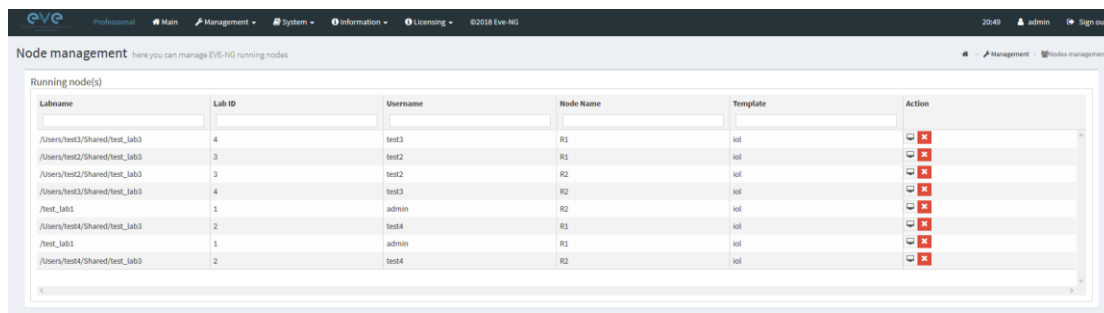

7.3.2.1 Node management actions

Button	Action
	Open a console session to the running node
	Stop the running node

7.3.2.2 Node management filtering function

Each column in the Node Management Menu has a field or sort sign that will allow you to filter the list to only display information related to the entered value.

Example: Click on “CPU Usage” The CPU column will sort running nodes with most CPU consumption on the top.

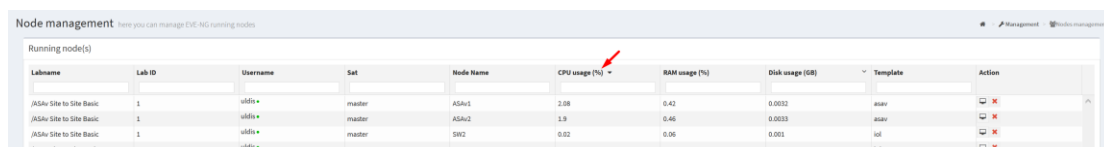

Each column can be sorted alphanumerically by clicking on the column name.

Example: click on the column Username and EVE will sort all running nodes in alphabetic order by username.

Node management here you can manage EVE-NG running nodes

Labname	Lab ID	Username	Sat	Node Name	CPU usage (%)	RAM usage (%)	Disk usage (GB)	Template	Action
(A)	2	admin	master	SW	0.02	0.07	0.001	inf	[stop] [refresh]
(A)	2	admin	master	Mgmt	0	0.03	0.0033	docker	[stop] [refresh]
(A)	2	admin	sat1	Win	0.13	4.85	0.3188	win	[stop] [refresh]
(A)	2	admin	master	ISR	0.02	0.08	0.001	inf	[stop] [refresh]
(A) Site to Site Basic	1	admin	master	ASW1	0.27	0.64	0.0038	asw	[stop] [refresh]

7.3.3 EVE Lab management

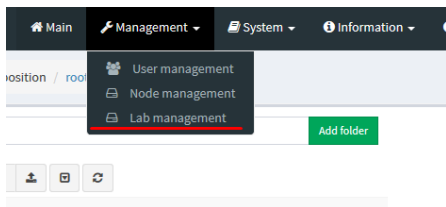

The Lab Management page, under the Management Dropdown, displays running or stopped labs for all users. In this menu an Admin account can manage or even open up any user's running labs. In the columns CPU and Memory usage will be displayed actual running lab CPU and RAM utilization.

- ⚠ NOTE: Only labs which are using space on EVE HDD will be displayed.
- ⚠ NOTE: Editor and User accounts are able to see and open their own running labs only
- ⚠ NOTE: Admin accounts are able to see, open, and join any users running or stopped lab.

Lab(s) management here you can manage EVE-NG Running Labs

Labname	State	Lab UUID	Satellite	Username	CPU usage (%)	Memory usage (%)	Disk usage (GB)	Action
/DC/EVPN-BGP-NXOSIR-PRO-LAB	●	4661d0cb-c3f2-4c83-e832-ca3f350018ef	sat1	admin	3.84	34.34	4.9088	[stop] [refresh]
/DC/EVPN-BGP-NXOSIR-PRO-LAB	●	4661d0cb-c3f2-4c83-e832-ca3f350018ef	sat2	admin	1.47	17.41	2.4736	[stop] [refresh]
/DC/EVPN-BGP-NXOSIR-PRO-LAB	●	4661d0cb-c3f2-4c83-e832-ca3f350018ef	master	admin	0	0	4.9687	[stop] [refresh]
/Users/edfor/test	●	00239193-3f8e-4b62-bd24-3a078905931a	sat2	edfor	0	0	0.0002	[stop] [refresh]
/Users/edfor/test	●	00239193-3f8e-4b62-bd24-3a078905931a	master	edfor	0	0	0.0002	[stop] [refresh]
/FTD Policy Lab v1	●	04855a95-281f-4b6e-8440-bf8863c1193	sat2	admin	0	0	2.6455	[stop] [refresh]
/FTD Policy Lab v1	●	04855a95-281f-4b6e-8440-bf8863c1193	sat1	admin	0	0	12.5394	[stop] [refresh]
/FTD Policy Lab v1	●	04855a95-281f-4b6e-8440-bf8863c1193	sat1	admin	0	0	0.7896	[stop] [refresh]

Several columns in the Lab Management Menu have a field that will allow you to filter the list to only display information related to the entered value.

Example: Enter username in the field to filter labs created by "admin"

Lab(s) management here you can manage EVE-NG Running Labs

Labname	State	Lab UUID	Satellite	Username	CPU usage (%)	Memory usage (%)	Disk usage (GB)	Action
/Security/ISE-dot1x-lab-new-iron	●	35849188-e3e3-4c21-a056-6675d9f90909	master	admin	0	0	0.0124	[stop] [refresh]
(A)	●	510ba4d5-9436-4d67-45c2-5ee1339868...	master	admin	0	0	0.002	[stop] [refresh]
/SD-WAN/SD-WAN-Lab	●	7895980e-3763-4038-b793-ba68227998...	master	admin	0	0	0.001	[stop] [refresh]
/Nicolaneos/OTV_Unitast	●	9772442a-b05e-4237-86d7-5a0570061...	master	admin	0	0	0.0002	[stop] [refresh]

Example: Click State to sort running labs on the top.

Lab(s) management here you can manage EVE-NG Running Labs

Labname	State	Lab UUID	Satellite	Username	CPU usage (%)	Memory usage (%)	Disk usage (GB)	Action
/DC/EVPN-BGP-NXOSIR-PRO-LAB	●	4661d0cb-c3f2-4c83-e832-ca3f350018ef	sat1	admin	3.25	34.34	4.9088	[stop] [refresh]
/DC/EVPN-BGP-NXOSIR-PRO-LAB	●	4661d0cb-c3f2-4c83-e832-ca3f350018ef	master	admin	0	0	4.9687	[stop] [refresh]
/DC/EVPN-BGP-NXOSIR-PRO-LAB	●	4661d0cb-c3f2-4c83-e832-ca3f350018ef	sat2	admin	2.97	17.41	2.4735	[stop] [refresh]
/Users/edfor/test	●	00239193-3f8e-4b62-bd24-3a078905931a	sat2	edfor	0	0	0.0002	[stop] [refresh]
/Users/edfor/test	●	00239193-3f8e-4b62-bd24-3a078905931a	master	edfor	0	0	0.0002	[stop] [refresh]
/FTD Policy Lab v1	●	04855a95-281f-4b6e-8440-bf8863c1193	master	admin	0	0	2.6455	[stop] [refresh]
/FTD Policy Lab v1	●	04855a95-281f-4b6e-8440-bf8863c1193	sat1	admin	0	0	0.7896	[stop] [refresh]

Example: Click on "Disk Usage" sorting labs with most HDD usage on the top

Labname	State	Lab UUID	Satellite	Username	CPU usage (%)	Memory usage (%)	Disk usage (GB)	Action
/POC Technology/Firepower 6-6 VFP P...	•	dd700e7-03b-465-8d8-4061a2e9f	master	uidi*	0	0	64.1963	[Stop] [Wipe]
/POC Technology/Firepower 6-6 DUJ ...	•	4d38f7b-e22-4d27-9d49-daaaac05d...	master	uidi*	0	0	62.0853	[Stop] [Wipe]
/TrustSec SXP Lab Book	•	f030c2c-e617-492b-a901-e5a72057475d	master	uidi*	0	0	40.7793	[Stop] [Wipe]
/Security/061x15E Lab w Android Bo...	•	18ab660-253e-49a4-a0d5-01a2ac7c...	master	uidi*	0	0	30.8903	[Stop] [Wipe]
/SD-WAN/SD-WAN FTD Lab	•	d279513-a1e9-425a-ac1a-586fe069801	master	uidi*	0	0	30.637	[Stop] [Wipe]

7.3.3.1 Lab management actions

Button	Action
	Open the running or stopped lab.
	Stop the running lab. The running labs will be displayed on top of list.
	Wipe lab. Clean up HDD space. NOTE: this action will delete saved lab configurations.

Once an admin has opened another user's running lab, that user's username will be displayed at the top of the left menu to help the admin keep track of which user's lab was opened.

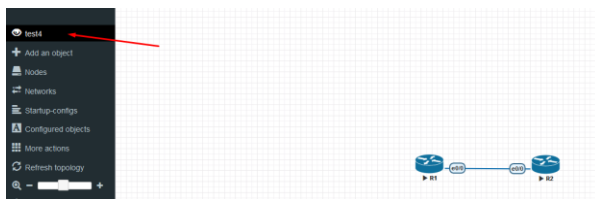

7.4 EVE System Dropdown menu

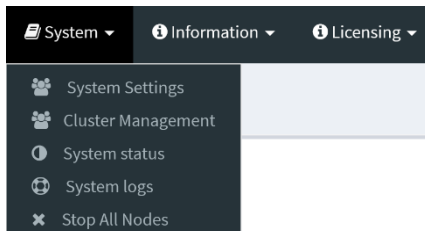

The EVE System dropdown contains the system settings, Cluster Management, system utilization status, log files, and an option to stop all running nodes on the server.

7.4.1 System Settings

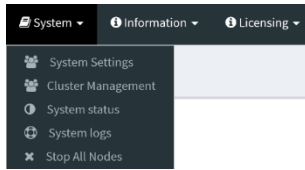

The System Settings page, under the System Dropdown, will show EVE System settings for:

System settings

Radius Server #1	IP 0.0.0.0	Port 1812	Secret *****
Radius Server #2	IP 0.0.0.0	Port 1812	Secret *****
Active Directory Server	IP 192.168.90.27	Port 389	Enable TLS <input type="checkbox"/>
Base DN	dc=eve,dc=lab		
EVE-NG Active Directory Group	EVE Users		
Proxy Server	IP 0.0.0.0	Port 0	User Password
Template visibility	unprovisioned images Disable		
Licence check	User's login control Strict		
Disk critical size	Minimal free space (GB) 3		
Html 5 terminal setting	Color scheme gray-black Font name monospace Font size 12		
Management interface setting	Enable IPV6 <input type="checkbox"/>		

Submit
Cancel

- External **Radius Server**, IP port and shared secret key
- **Active Directory** Authentication support
 - ✓ IP address of AD and port 389 or 3268 (TLS)
 - ✓ For TLS Active directory communication option, select **TLS**
 - ✓ DN: Example if domain is **eve.lab**, then DN syntax is: **dc=eve,dc=lab**
 - ✓ EVE-NG Active Directory Group: Example: EVE Users. EVE will search Your Group name in whole domain folder tree.

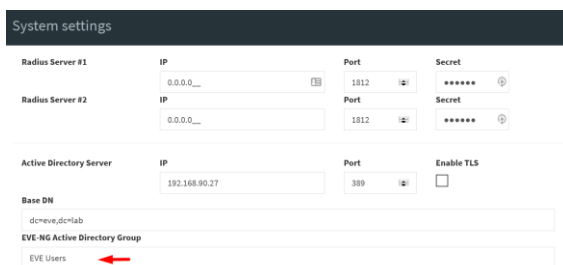

Note: The username in of the Active directory user account must match with AD username. Username must have domain at the end of username. Example: **evelabuser@eve.lab**

- **Proxy server** IP and port, for authenticated proxy use username and password
- **Template visibility** is default settings for templates list on topology. Disable state (default) will not show on topology Nodes list with unloaded images. In the Nodes list will appear only uploaded images. The checkbox "Show unprovisioned templates" will show all available image templates.

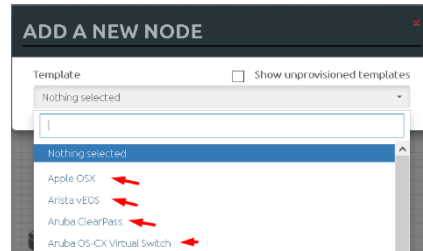

- **License check** is value where you can set EVE user session login behave.
 - ✓ The Value **Strict** does not allow user login if all available licenses have active sessions (screenshot below, Insufficient Licenses). If user has finished work with EVE server and closed browser, EVE server will clear this user connection session automatically after 1 minute.
 - ✓ The **Auto logout** will terminate oldest connected user session to the EVE server.

Note: Administrator has rights terminate any user session, please refer Section: **7.3.1.3**

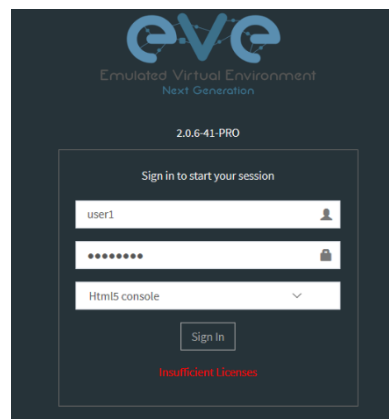

- **Disk critical size** is value when EVE will start alert you about HDD space limit is reached. If you will set 5Gb value, your EVE will start show warning messages in notification area. Example is showing limit set to 500GB. Recommended is set 3-5 GB value.

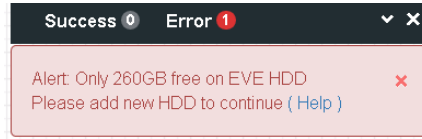

- **HTML5 Terminal settings** Option to change console colour scheme, fonts, font size and backgrounds.



- **Management interface settings** Option to enable IPv6 on the EVE Management interface

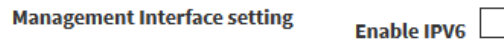

7.4.2 Cluster Management

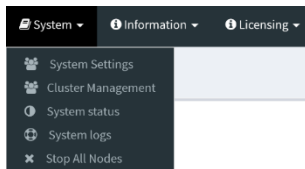

The Cluster Management page, under the System Dropdown, will show Cluster Management options, and cluster members resources utilization. Please refer to Chapter EVE Cluster System **15**

7.4.3 System status

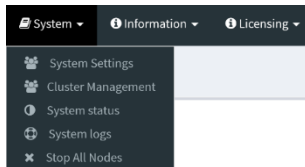

The System Status page, under the System Dropdown, will show EVE server resource utilization, the number of running nodes per template, current running versions of EVE and Qemu, and the current status of the UKSM and CPU Limit options.

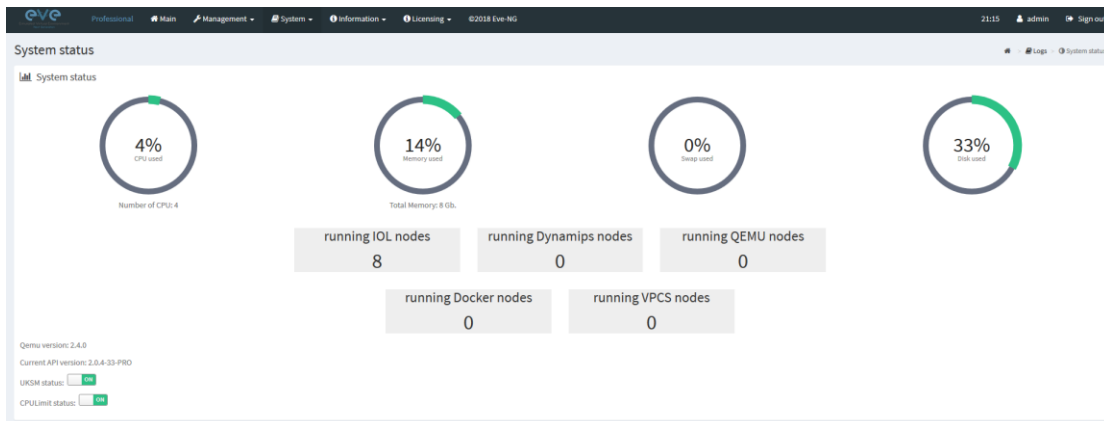

UKSM – “Ultra KSM (kernel same-page merging) is a Linux kernel feature that allows the KVM hypervisor to share identical memory pages among different process or virtual machines on the same server.” It can be disabled globally for EVE on this page. It is recommended to keep UKSM **enabled**.

Template
Cisco vIOS

Number of nodes to add
1

Image
vios-adventerprisek9-m-15.6.2T

Name/prefix
vIOS

Icon
Router.png

UUID

CPU Limit

CPU 1 **RAM (MB)** 1024 **Ethernets** 4

CPU Limit – CPU limit is used to limit CPU overloads during the nodes run time. It acts like a smart CPU usage option. If a running node reaches 80% CPU utilization, the CPU Limit feature throttles CPU use for this node to 50% until process usage drops under 30% for a period of 1 minute.

It is recommended to keep the Global CPU Limit option enabled.

CPU Limit can be turned for individual nodes in a lab. EVE node templates are set, by default, with the recommended CPU limit settings. An Unchecked CPU Limit option means that this node will boot without CPU

limit.

Reference:

<https://searchservervirtualization.techtarget.com/definition/KSM-kernel-samepage-merging>

7.4.4 System logs

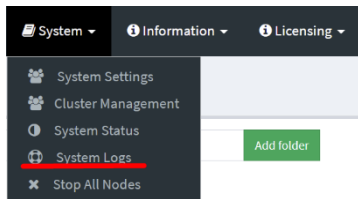

The System logs page, under the System Dropdown, will display EVE server log information

In the menu you can select a specific log file for inspection.

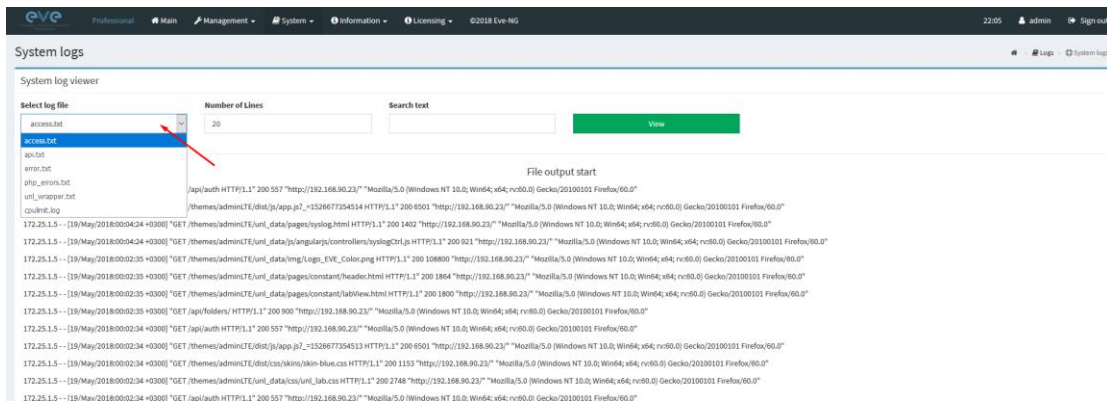

7.4.5 Stop All Nodes

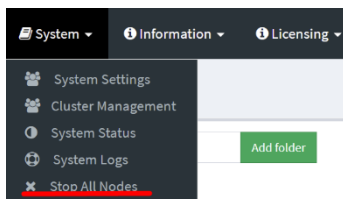

The Stop All Nodes option, under the System Dropdown, is an option that stops all running nodes on the EVE server. This option is accessible only by Admin users.

Same can be achieved issuing cli command:

```
/opt/unetlab/wrappers/unl_wrapper -a stopall
```

7.5 EVE Information Dropdown menu

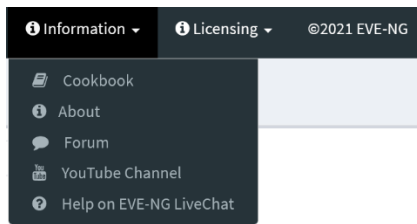

The Eve Information Dropdown contains links to the EVE Website, EVE forum, EVE YouTube channel, and the web-based EVE Live Help chat.

To join the EVE Forum, in order to make posts or download materials, a forum user account must be created.

To join the EVE Live Chat for support, please use your Google account for access, or create a new user account for this chat. Please note the forum and live chat use separate user accounts.

7.6 EVE Licensing Dropdown menu

The EVE Licensing dropdown contains options for managing your EVE license.

The License Information Window will display the expiration date along with the number of licenses that have been activated

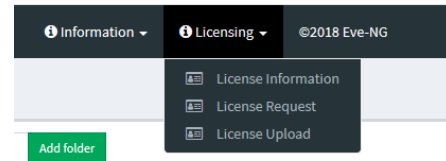

License information display:

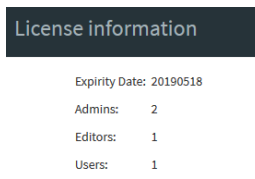

For License Request and License Upload, please refer to section [4.5](#) for more information.

7.7 Other Tab line info

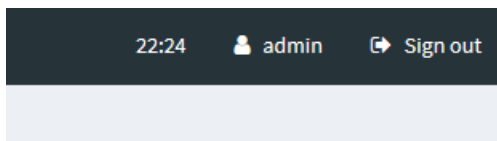

Other items on the top menu are: Real-time clock, a shortcut to edit the currently logged in user, and a sign-out button.

7.8 Lab preview and global settings

Once you click on a lab in the folder tree, a main window on the right side will display schematic content of the lab as well as lab management options like open, edit, and delete.

The actual lab topology appears after 3-5 seconds.

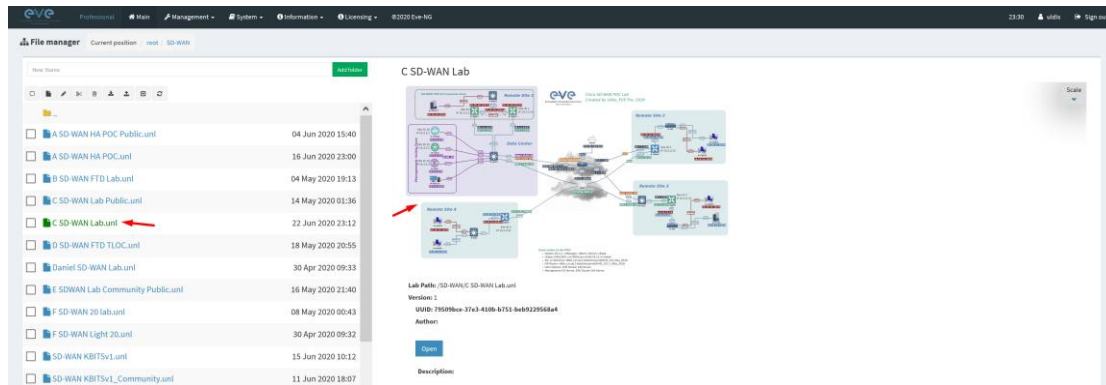

7.8.1 Lab preview window

The lab preview window displays the schematic position of nodes and their connectivity. The actual lab topology appears after 3-5 seconds. The Scale option allows you change the lab preview size.

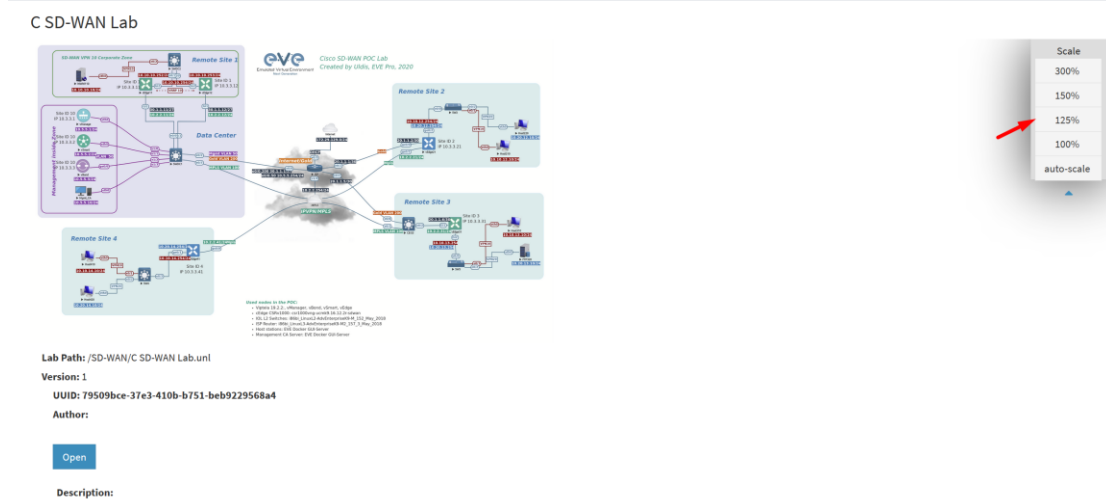

7.8.2 Lab preview buttons

In the lab preview, these buttons allow you to manage the selected lab.

Button	Description
	Opens the Lab to the Topology Canvas
	Opens the Labs Global Settings. Refer to section 7.8.4 for more info.
	Deletes the lab

7.8.3 Lab preview information

Description, version, UUID etc.

Lab Path: /test_lab1.unl

Version: 12

UUID: 95692558-5acb-4308-ab66-64f9b40bd31f

Author: John Tester

Description:

Here is short description of Lab

7.8.4 Lab Global Settings

Lab Global Settings Page is opened when you click on  the Edit button below the Lab preview window.

This page allows you to fill out important information about the lab. The red numbers in the picture correlate with the numbers listed below

1. Lab name.
2. Version: Version numbers allow a lab author to assign a value to a unique state of a lab. Increase the number to correspond to new developments in the lab. If left unfilled, EVE will assign a value of 1 automatically.
3. Author: You can add a lab author name in this field
4. EVE Cluster Satellite choice. By default, EVE will assign a value of “any” automatically. For cluster hierarchy please follow: Chapter [15.8.2](#)
5. Lab sharing Feature, please follow Chapter [9.11](#)
6. Config Script Timeout: It is the value in seconds used for the “Configuration Export” and “Boot from exported configs” operations. Refer to section [11.3](#) for more information.
7. Lab Countdown Timer: It is the value in seconds to provide a time limit (countdown timer) for completing a lab. Refer to section [11.4](#) for more information.
8. Description: In the Description field you can write a short description of the lab.

9. Tasks: In the Tasks field you can write the task for your lab.



The Lab details window can be opened from the Topology Canvas page sidebar during labbing, to read the Tasks for the lab.

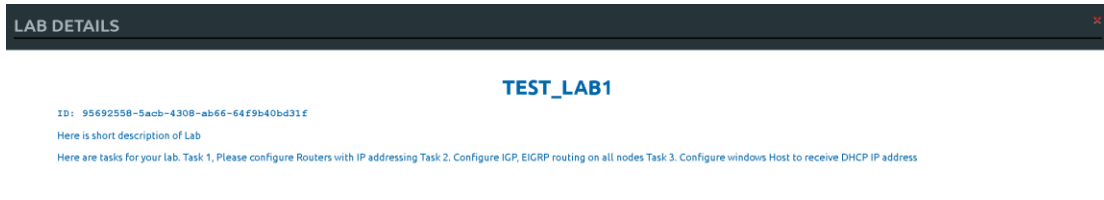

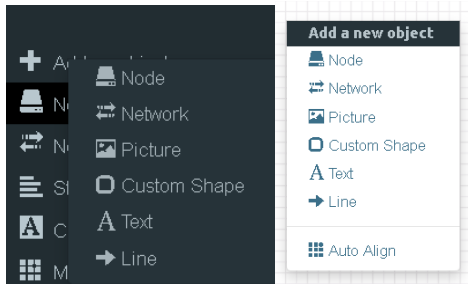

8.1.1.1 Node object

The Node object opens the “Add a new node” window. Only nodes that appear blue in the dropdown menu can be added. A grey image name signifies that you have not yet properly uploaded an image to the proper folder. A blue image name means that at least one image exists in the proper folder for this template. If the “Show unprovisioned templates” is checked, EVE will display unloaded image templates. To hide it, uncheck “Show unprovisioned templates” checkbox or follow section [Error! Reference source not found.](#)

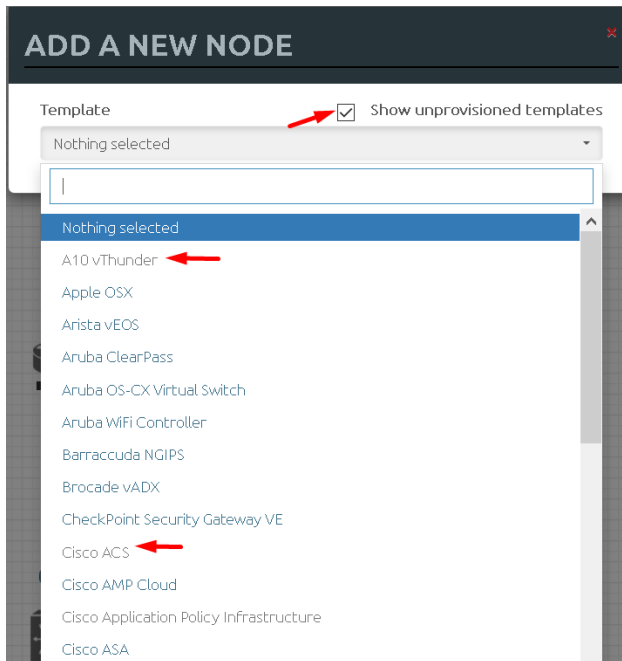

8.1.1.2 Network object

The Network object opens the “Add a new network” window. This function is used to add any kind of network (Cloud, Bridge or NAT). For details on these, please refer to section [10](#)

ADD A NEW NETWORK ✕

Number of networks to add:

Name/Prefix:

Type: bridge

Left:

Top:

8.1.1.3 Picture object

The picture object opens the “Add Picture” window and allows you to upload custom topologies in jpg or png format. After uploading, you can edit these pictures and map selected areas to nodes from the topology to use your own designs as a lab topology from which you can directly connect to the nodes. For details, refer to section [11.2](#)

ADD PICTURE ✕

Name:

Picture: anycon_lab.PNG

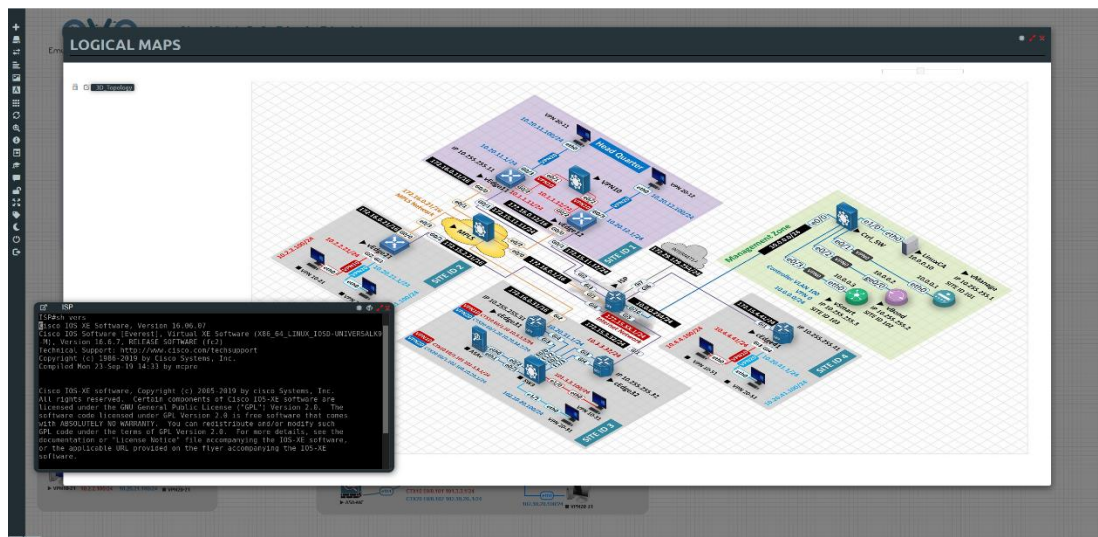

8.1.1.4 Custom shape object

The Custom shape object allows you to add shape elements onto the topology; these currently include squares, round squares and circles. For details, refer to section [11.1](#)

ID	NAME	TEMPLATE	BOOT IMAGE	CPU	CPU USAGE	CPU LIMIT	IDLE PC	NVRAM (Kb)	RAM (Mb)	RAM USAGE	ETH	SER	CONSOLE	ICON	STARTUP-CONFIG	ACTIONS
2	ISP	ios	ib66_linux12-adv-enterprise9-k9-157_3_May_2018.bin	n/a	1.2%	n/a	n/a	1024	2048	0.6%	2	0	telnet	Router2.png	Default	[Start] [Stop] [Wipe] [Export] [Edit] [Delete]
3	Mgmt_CA	docker	eve-gui-server-latest	4	0%	n/a	n/a	4096	0.9%	1	n/a	n/a	rdp	Desktop3.png	Default	[Start] [Stop] [Wipe] [Export] [Edit] [Delete]
4	SW1C1	ios	ib66_linux12-adv-enterprise9-ml-SSA-high_ios_20190423.bin	n/a	2%	n/a	n/a	1024	1024	0.3%	4	0	telnet	Switch_L32.png	Default	[Start] [Stop] [Wipe] [Export] [Edit] [Delete]
5	SW2	ios	ib66_linux12-adv-enterprise9-ml-SSA-high_ios_20190423.bin	n/a	0.8%	n/a	n/a	1024	1024	0.2%	4	0	telnet	Switch2.png	Default	[Start] [Stop] [Wipe] [Export] [Edit] [Delete]
6	SW3	ios	ib66_linux12-adv-enterprise9-ml-SSA-high_ios_20190423.bin	n/a	1.4%	n/a	n/a	1024	1024	0.2%	4	0	telnet	Switch2.png	Default	[Start] [Stop] [Wipe] [Export] [Edit] [Delete]
7	vEdge11	csr1000mg	csr1000mg-scsm6.16.12.3-sdwan	2	100%	n/a	n/a	n/a	4096	100%	4	n/a	telnet	vEdge.png	None	[Start] [Stop] [Wipe] [Export] [Edit] [Delete]
8	vManage	vtagmt	vtagmt-19.2.2	4	0%	n/a	n/a	n/a	24576	0.5%	2	n/a	telnet	vManage.png	None	[Start] [Stop] [Wipe] [Export] [Edit] [Delete]
9	vSmart	vsmart	vsmart-19.2.2	2	0%	n/a	n/a	n/a	3048	0.5%	2	n/a	telnet	vSmart.png	None	[Start] [Stop] [Wipe] [Export] [Edit] [Delete]
10	vBond	vbond	vbond-19.2.2	1	0%	n/a	n/a	n/a	1024	0.5%	2	n/a	telnet	vBond.png	None	[Start] [Stop] [Wipe] [Export] [Edit] [Delete]

In this window, you can make changes for nodes that are on the lab topology. More options can be found in the detailed node specific menu, for details refer to section 9.1.2.

⚠ NOTE: Running nodes are highlighted in Blue, their settings cannot be changed. You can only change settings of nodes that are not currently running.

You can change the following values:

- Node Name
- Boot image
- Number of CPUs for the node
- Live CPU usage
- Enable or disable CPU Limit (Refer to section 7.4.3)
- IDLE PC for Dynamips node
- NVRAM in Kbyte
- RAM in Mbyte
- Live RAM usage
- Ethernet quantity. **NOTE:** The Node must be disconnected from any other nodes to make this change. You cannot change the interface quantity if the node is connected to any other node.
- Serial interface quantity, IOL nodes only. You cannot change Serial interface quantity if the node is connected to any other node.
- Type of Console
- Node Icon that appears on the Topology
- Startup configuration to boot from

Actions Buttons (Stopped node):



- Start node
- Stop node
- Wipe node
- Export the nodes config
- Networks
- Edit node
- Delete Node

Actions Buttons (Running node):

ACTIONS



- Console to the node
- Stop node
- Wipe node
- Export the nodes config
- Edit node
- Delete Node

8.1.3 Networks

Networks

The Networks object in the sidebar will open the “Configured Networks” window.

The “Configured Networks” window will only show networks that were specifically added to the topology; it will not show node interconnections. The example below is showing information for networks on the Topology. For Cloud networks and how to connect EVE labs to a network external to EVE, please refer to section 10

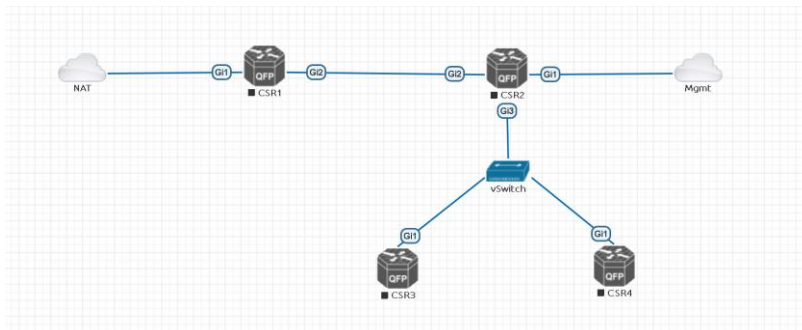

CONFIGURED NETWORKS

ID	NAME	TYPE	ATTACHED NODES	ACTIONS
1	NAT	nat0	1	
2	Mgmt	paet0	1	
3	vswitch	bridge	3	

ACTIONS



- Edit Network
- Delete Network

8.1.4 Startup-configs

Startup-configs

The Startup-configs object in the sidebar opens the “Startup-configs” window.

This window will show you startup-config for each node (for PRO it shows the startup configs of the current config set) and if the node is set to boot from it (ON) or not (OFF).

The “Startup-configs” window in the EVE Professional version contains additional features, please refer to section 11.3.

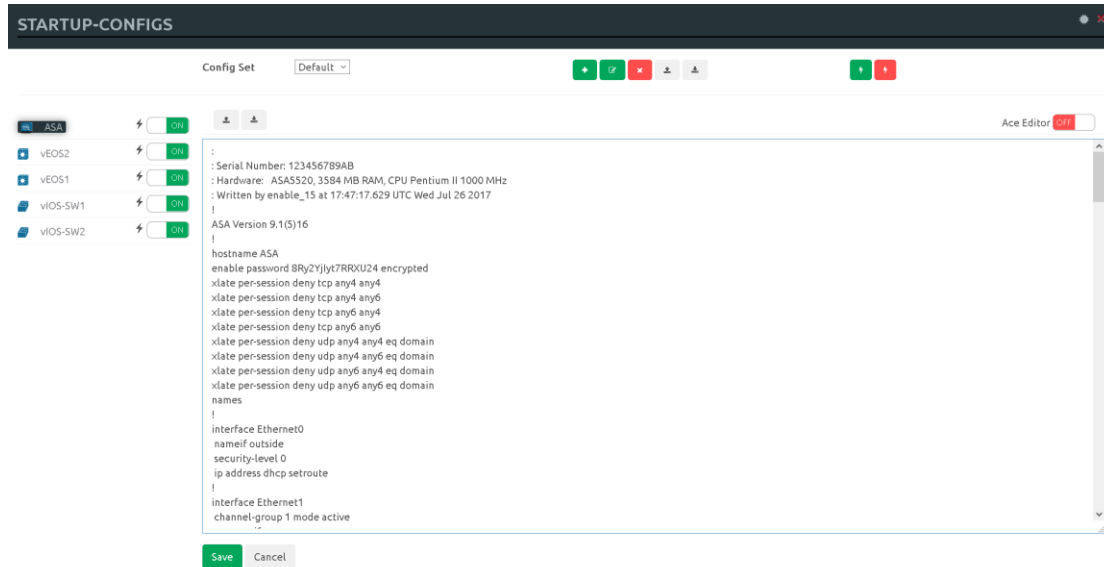

8.1.5 Logical Maps



Pictures

NOTE: The Logical Maps object will only appear in the sidebar after you have uploaded a custom topology picture to the lab EVE lab (Please refer to section 8.1.1.3). The Pictures object in the sidebar opens the “Picture Management” window.

For details on the Picture / custom topology feature, refer to section 11.2

8.1.6 Configured Objects



Configured objects

The “Configured Objects” window will display a list of all objects that are added onto the topology. For details on different objects, refer to section 11.1

NOTE: You will not see any objects in this window if none have been added to the lab yet.

CONFIGURED OBJECTS				
ID	NAME	TYPE	TEXT	ACTIONS
1	lab 1	text	Topology vrx	⋮
2	square2	square		⋮

8.1.7 More actions

The More actions menu in the sidebar has a submenu with the following functions.

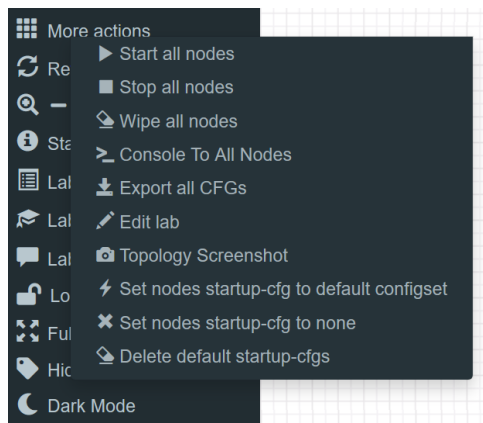

8.1.7.1 Start all nodes

▶ Start all nodes The “Start all nodes” action will start all nodes on your topology, taking the (configurable) startup delay of each node into consideration.

⚠ IMPORTANT. Starting many nodes at once can seriously spike your CPU utilization. Please make sure that you are not using the “Start all nodes” option for heavy labs or that you have configured a proper delay between the nodes. For heavy nodes and large quantities, it is recommended to start them in smaller groups, wait for them to finish booting and then start another small group of nodes.

8.1.7.2 Stop all nodes

■ Stop all nodes Stopping all nodes will power off all nodes on your topology.

⚠ NOTE: It is recommended to save your (running) configurations on the nodes in your lab before you stop the lab if you want to continue where you left off the next time. Stopping the nodes will leave the images in a temporary folder and will take up space on your drive until they have been wiped.

8.1.7.3 Wipe all nodes

🗑 Wipe all nodes The “Wipe all nodes” action will wipe the NVRAM or currently saved image of all your nodes in the current lab.

Example: You have saved the nodes configuration by saving the running configuration to the startup configuration. The Wipe command will delete the saved NVRAM startup configuration and on the next boot it will boot from factory defaults.

The same applies to images without configurations, e.g. a linux node. If you make modifications to the system and afterwards wipe this node, the next time it will boot from the original base image again as the modified image was deleted.

The “Wipe node” action is commonly used with initial startup configuration modifications. The Wipe node action does not delete configured startup configurations or sets. Please refer to section [11.3](#)

8.1.7.4 Console to All Nodes

 Console To All Nodes

“Console to all nodes” will open a console to all of your running nodes in the current lab. This includes all different kinds of configured console types for lab nodes like VNC, Telnet and RDP.

8.1.7.5 Export all CFGs

 Export all CFGs

The “Export all configurations” action will export current configs to the EVE startup-configs.

Export configurations are supported for:

<p>Cisco Dynamips all nodes Cisco IOL (IOS on Linux) Cisco ASA Cisco ASA v Cisco CSR1000v Cisco Nexus 9K Cisco Nexus Titanium Cisco vIOS L3 Cisco vIOS L2 Cisco Viptela vEdge, vSmart, vBond, till version 18.4 only, version 19.x and later is not supported due implemented password setup feature on the first boot. Cisco XRv Cisco XRv9K</p>	<p>Juniper VRR Juniper VMX Juniper vMX-NG Juniper vQFX Juniper vSRX Juniper vSRX-NG Mikrotik PFsense FW Timos Alcatel vEOS Arista</p>
---	---

For a full explanation of exporting configurations, please refer to section [11.3](#)

8.1.7.6 Edit lab

 Edit lab

Opens the Edit lab window. Refer to section: [7.8.4](#)

EDIT LAB

Path:

Name:
Use only [A-Za-z0-9_]. 25max

Version:
Must be integer (0-9)max

Author:

Config Script Timeout: Seconds

Lab Countdown Timer: Seconds

* Required Fields

Description: Arista MLAG and ASA Lab

Tasks

LAB Scenario

1. Configure ASA ports in etherchannels (mode active) and vlan interfaces per design, name it as DMZ and Corporate respectively
2. Configure ASA vIOS with DHCP IP must receive IP from home LAN and name this port as outside
3. Configure ASA management on port e0, and WAN? Agreed host per design, ASA must be reachable from Mgmt PC over ASDM
4. Configure Arista vEOS in mlag and assign ports in etherchannels per design
5. Configure Arista vEOS etherchannel ports facing to ASA in etherchannel mode active
6. Configure vEOS etherchannel facing to vEOS-SW in etherchannel mode on

8.1.7.7 Topology screenshot

 Topology Screenshot

Feature to export actual topology in png format

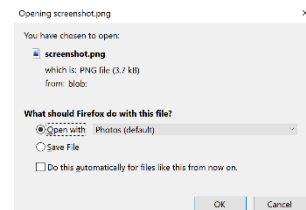

8.1.7.8 Set node's startup-cfg to default configset

⚡ Set nodes startup-cfg to default configset

Sets nodes to the default startup-config. NOTE: If you have nothing saved in the default config set for any node, that node will boot from factory default instead. This is commonly used with the wipe nodes function so the node will boot from the configured startup-config on next boot and not from the startup-config in its NVRAM in case the node was started before already.

Please refer to section [11.3](#)

8.1.7.9 Set node's startup-cfg to none

✖ Set nodes startup-cfg to none

Setting all lab nodes to boot from factory default. Used commonly with the wipe nodes function. The example below shows the steps to set a lab to boot from factory default.

Step 1: Wipe all nodes

Step 2: Set all nodes to startup-cfg none

Please refer to section [11.3](#)

8.1.7.10 Delete default startup-cfgs

🗑 Delete default startup-cfgs

⚠ WARNING: this action will delete all configurations saved to your saved default config set. Please make sure that is what you want to do before you execute this.

8.1.8 Refresh Topology

🔄 Refresh topology

Sometimes it is necessary to refresh the topology if many objects are added on the topology.

8.1.9 Lab page zoom/unzoom



This action is used to zoom or unzoom a large topology in EVE.

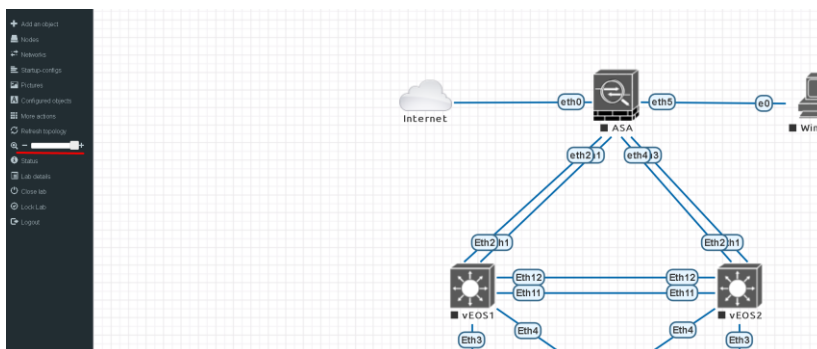

8.1.10 Status

📄 Status

Opens the EVE Status window.

Especially useful while working with labs to monitor your EVE's resource utilization. It shows EVEs CPU, RAM and disk utilization in real time. You can also see the number of running nodes per node type. For details on UKSM and CPU Limit, please refer to section [7.4.3](#)

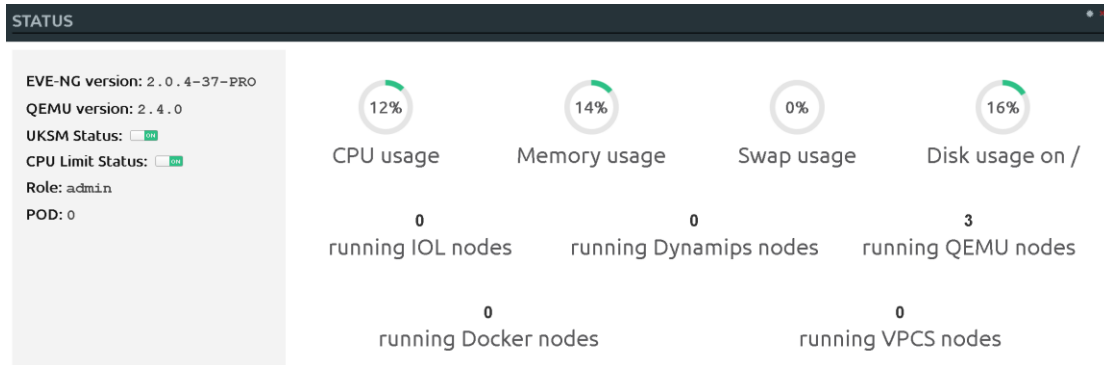

8.1.11 Lab details



Lab details display information about a lab, its UUID, description and lab tasks. To edit the lab description and lab tasks, please refer to section [7.8.4](#) and [8.1.7.6](#)

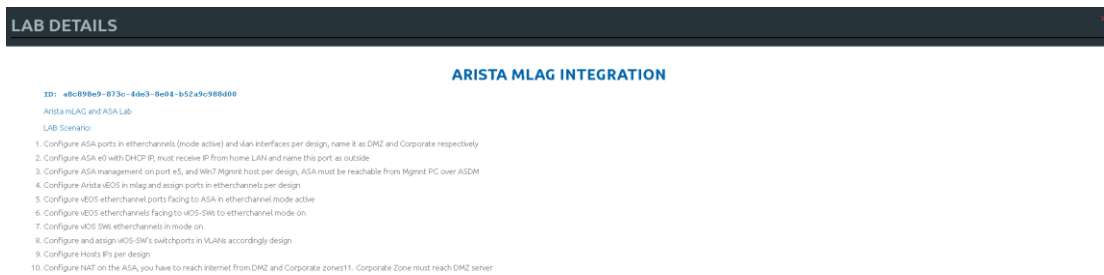

8.1.12 Lab Tasks

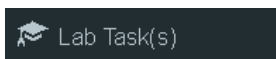

Opens a Lab Task feature. The EVE LabTasks is a feature that allows users (including admins and editors) to create task or workbook for the Labs. Detailed how to create lab workbooks please refer Section [11.5](#)

8.1.13 Lab Chat



Opens a Lab chat session between users on the same EVE server. To activate the chat, click "Lab Chat" on the sidebar. To close and exit from the chat, click "Lab Chat" on the sidebar again. The EVE Lab chat is a feature that allows users (including admins/teachers) to communicate with each other during lab sessions.

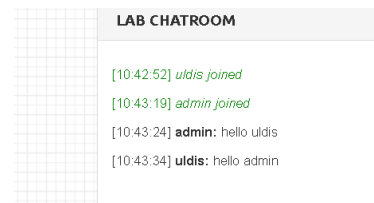

8.1.14 Lock Lab with password

"Lock Lab" disables some of the functions on the lab topology. If the lab is locked, you cannot move any node or object nor edit any node settings. Basically, the whole lab will be in read-

only mode except for the lab settings itself, which you can still edit as Administrator or Editor from the main menu. The Lock Lab function is also used in conjunction with the countdown timer function, for details on this please refer to section [11.4](#)

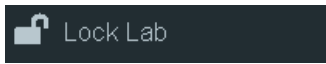
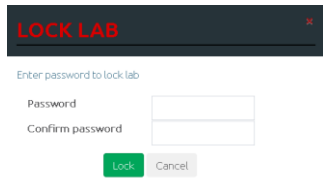
 <p>Lab is unlocked and all operations are working</p>	 <p>Enter and confirm your lab lock password</p>
---	--

To unlock a Lab, simply press on the red “Unlock Lab” button with an Administrator or Editor account.

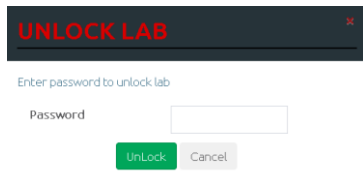
 <p>Lab is locked and all operations are restricted</p>	 <p>Enter lab unlock password to unlock lab.</p>
--	---

Warning: Please remember your Lab lock password. In case of a lost password, you will not be able to recover it. Unlocking a lab / removal of password can be done by EVE-NG support only.

8.1.15 Fullscreen

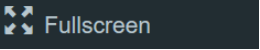
	<p>“Fullscreen” Fullscreen function is stretching your lab to the full monitor screen. To get back to normal web screen hit “ESC” or press “Fullscreen” again.</p>
---	--

8.1.16 Hide interface labels

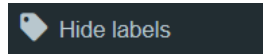
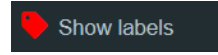
 <p>Hide interface labels for lab nodes</p>	 <p>Show interface labels for lab nodes</p>
--	---

8.1.17 Dark mode or Light mode

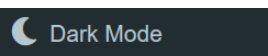
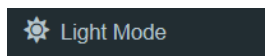
 <p>Sets your lab background to the dark mode</p>	 <p>Sets your lab background to light mode</p>
--	--

8.1.18 Close lab



Closes the lab topology. The lab can be closed while the nodes in the lab are still running as well. It will appear as running lab under the Running folder. Please refer to section [7.2.1.1](#)

8.1.19 Logout



Log out from the EVE WEB GUI session.

8.2 EVE Lab topology menus

Right-clicking within the EVE topology can open new menus with various functions and options for managing nodes.

8.2.1 Lab topology menu

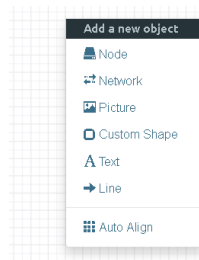

Right-clicking on the (free/unused) canvas of the EVE topology opens a new menu. (Add-) Node, Network, Picture, Custom Shape and Text are the same functions referred to in section [8.1.1](#).

Auto Align. This function will help align objects on the topology. The lab creator does not need to worry about small displacements of objects. AutoAlign will align all objects to a virtual grid with a single click and can make neatly arranged labs look even neater.

8.2.2 Connection menu

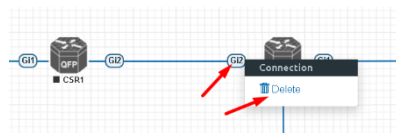

Right-clicking on the connection between nodes allows you to delete this connection.

8.2.3 Cloud or Bridge network menu

Right-clicking on a Cloud or Bridge network allows you to edit or delete it.



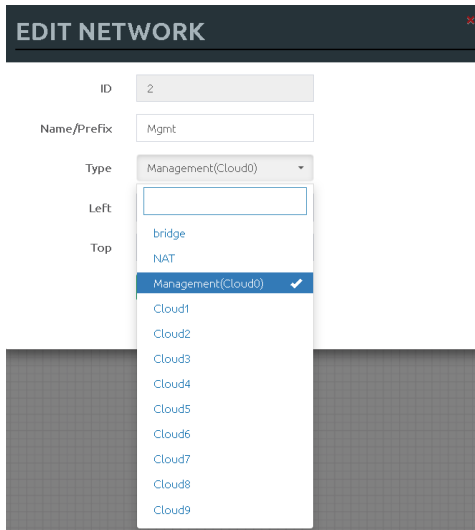

If you have chosen Edit, the Network edit window will open a window where you can change the placement, network type or name/prefix.

For details on how to operate EVE Cloud networks and external connections, please refer to section 10

8.2.4 Stopped node menu

Right-clicking on a stopped node also opens a menu:

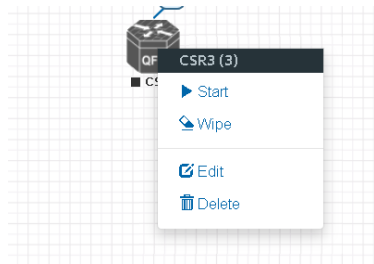

Start node: This will start the selected node in this lab

Wipe node: Wiping a node will erase the NVRAM (running config) or the temporary image snapshot depending on the type of node. This option is used to clean up a node in order to boot it from factory defaults or a custom set of configurations.

Edit node: Opens the Edit node window (picture on the right). For details please refer to section 9.1.2

Delete node. Deletes the node from the lab. It is recommended to disconnect (delete connections to it) the node before you delete it.

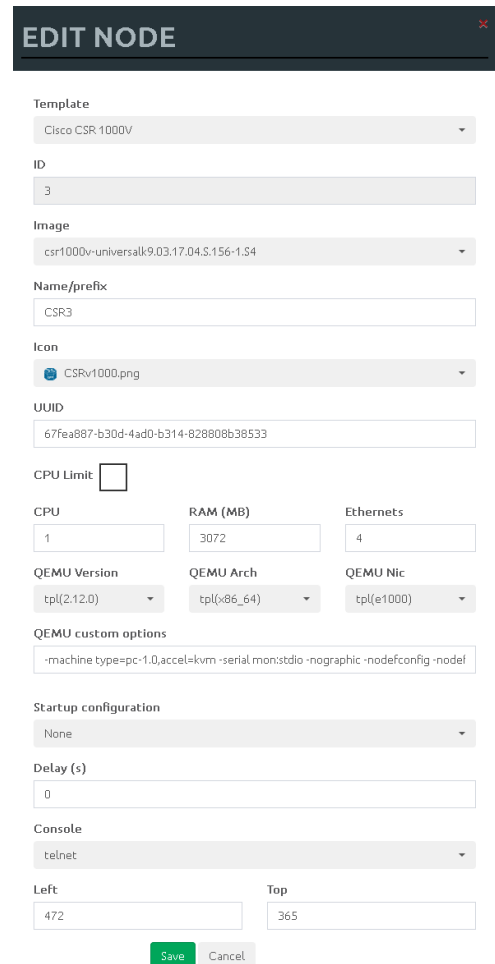

8.2.5 Running node menu

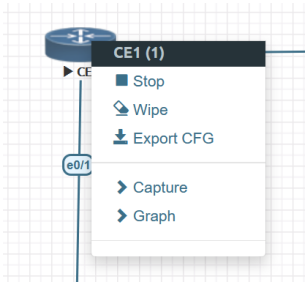

Right-clicking on a running node also opens a menu:

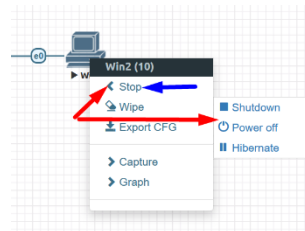

Stop. Blue arrow: clicking on Stop will stop the node depending on the method the node supports (power off / shutdown are auto-selected based on the template)

Stop menu. Red arrows: There are more options to stop a node, clicking on the chevron on the left side of “Stop” opens a submenu.

- **Shutdown:** Perform an orderly shutdown of the node if that node supports it (shutdown signal is sent down to the node)
- **Power off:** Kills the running nodes process within EVE (hard poweroff).
- **Hibernate.** Save Node state (Disk and Memory are saved in an internal snapshot). Used for fast boot of a node. The hibernation process can take some time. Once the hibernation process is completed, the node will turn grey (shutdown state).

Wipe node: Wiping a node will erase the NVRAM (running config) or the temporary image snapshot depending on the type of node. This option is used to clean up a node in order to boot it from factory defaults or a custom set of configurations.

Export CFG: This function is used to export the saved running configuration to the EVE startup configuration sets. Reference section [11.3](#)

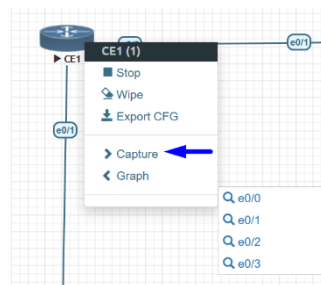

Capture. Integrated live Wireshark capture. Select the interface which you wish to capture. Reference section [12](#)

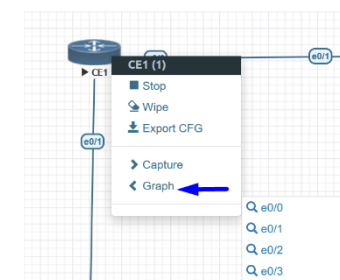

Graph. Integrated live interface activity monitoring. Displaying live interface utilization activity.



8.2.6 Selected nodes menu and features

It is possible to select many objects or nodes at once in EVE. Using your mouse, you can select an area which will cover your nodes and/or you can click on nodes while holding the CTRL key on your keyboard.

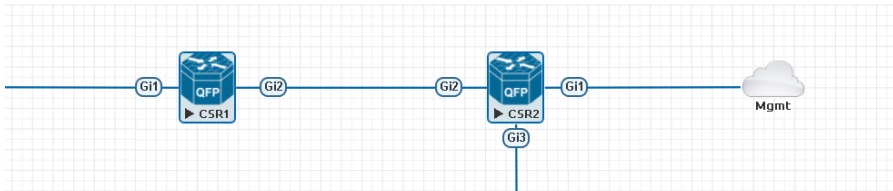

A right-click on any of the selected nodes opens a group menu:

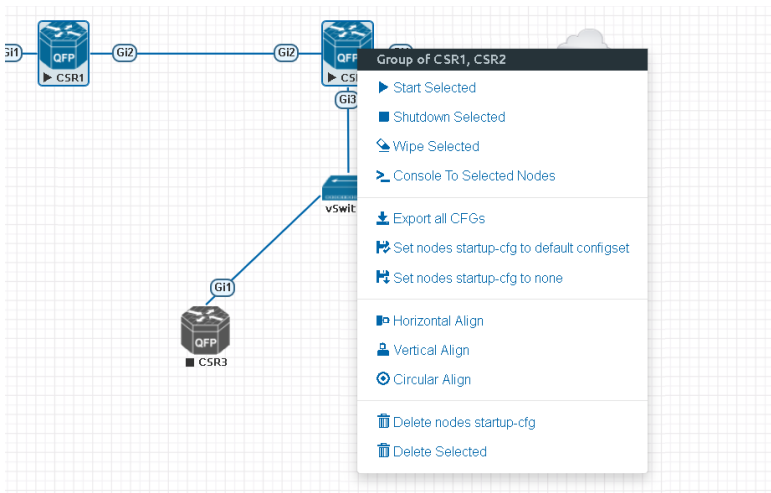

Start Selected: This will start the selected nodes in this lab.

Stop Selected: This will stop the selected nodes in this lab

Wipe Selected: The Wipe Selected nodes action will wipe the NVRAM or currently saved image of the selected nodes in the current lab.

Example: You have saved the nodes configuration by saving the running configuration to the startup configuration. The Wipe command will delete the saved NVRAM startup configuration and on the next boot it will boot from factory defaults.

The same applies to images without configurations, e.g. a linux node. If you make modifications to the system and afterwards wipe this node, the next time it will boot from the original base image again as the modified image was deleted.

The Wipe node action is commonly used with initial startup configuration modifications. The Wipe node action does not delete configured startup configurations or sets. Please refer to section [11.3](#)

Console To Selected Nodes: Console To Selected Nodes will open a console to all selected running nodes in the current lab. This includes all different kinds of configured console types for lab nodes like VNC, Telnet and RDP

Export all CFGs: The Export all configurations action will export current configs of selected nodes to the EVE startup-configs.

For a full explanation of exporting configurations, please refer to section [11.3](#)

Set nodes startup-cfg to default configset: Sets nodes to Default startup config, used commonly with the wipe nodes function. NOTE: If you have nothing saved in the default config set for any node, that node will boot from factory default instead. This is commonly used with the wipe nodes function so the node will boot from the configured startup-config on next boot and not from the startup-config in its NVRAM in case the node was started before already.

Please refer to section [11.3](#)

Set nodes startup-cfg to none. Setting selected lab nodes to boot from factory default. Used commonly with the wipe nodes function. The example below shows the steps to set selected nodes to boot from factory default.

- Step 1: Wipe selected nodes
- Step 2: Set nodes startup-cfg to none

Please refer to section [11.3](#)

Horizontal Align. Aligns the selected nodes in one horizontal line.

Step 1: Select the nodes you wish to align.

Step 2: Right click on one of the selected nodes and choose Horizontal align, this will align all nodes to the selected node.

Picture before:

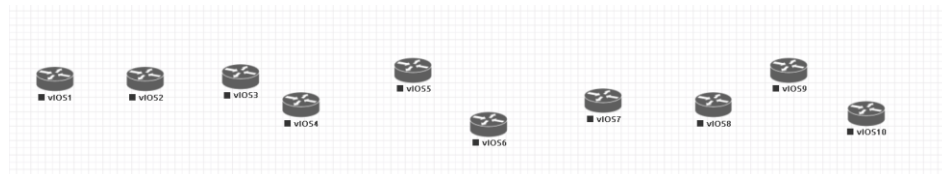

Picture after:



Vertical Align: Aligns the nodes in one vertical line.

Step 1: Select the nodes you wish to align.

Step 2: Right click on one of the selected nodes and choose Vertical align, this will align all nodes to the selected node.

Picture before

Picture after

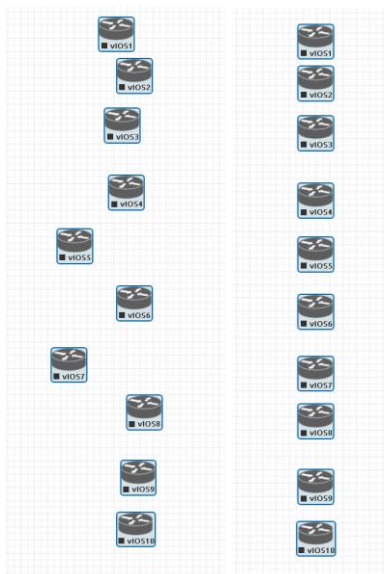

Circular Align: Aligns the nodes in a circle.

Step 1: Select the nodes you wish to align.

Step 2: Right click on one of the selected nodes and choose Circular Align, this will align all nodes in a circle, the midpoint of the circle will be at the coordinates the selected node was at before.

Picture Before

Picture After

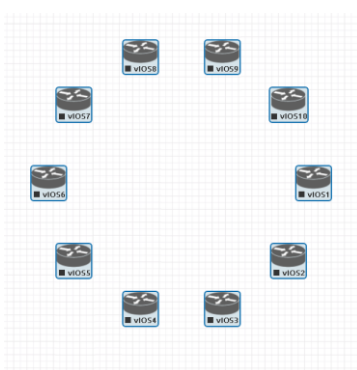
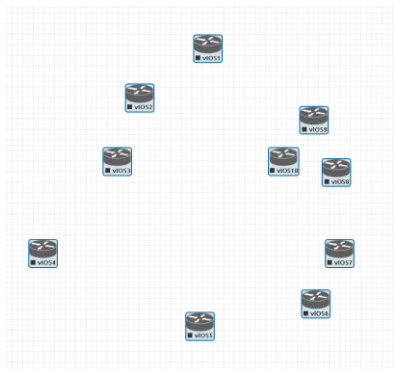

Delete nodes startup-config.

- ⚠ WARNING, this action will delete the configurations of the selected nodes that are saved to your Default config set. Please make sure that is what you want to do before you execute this.

Delete selected: This will delete the selected nodes from your current lab.

Selected nodes can be moved as a group across the topology.

Example: You can select nodes and objects to better position them on the Topology.

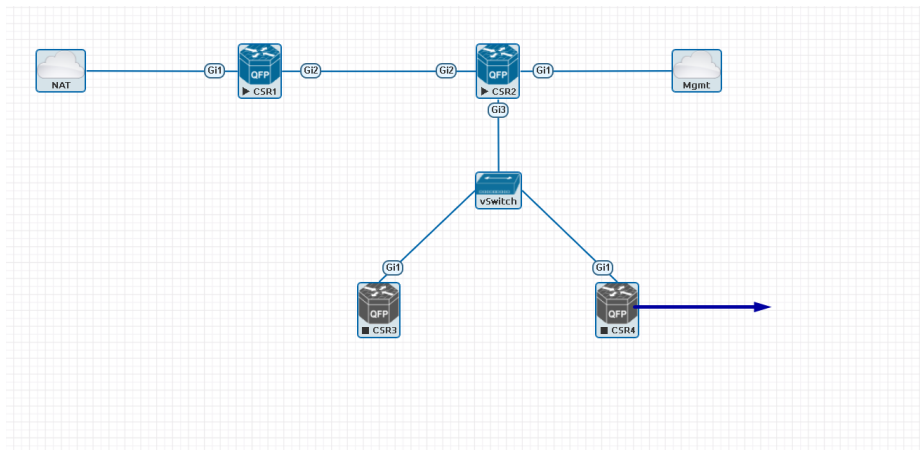

8.3 EVE Lab node states and symbols

8.3.1 Stopped (non-running) nodes



Grey colour and a square symbol below a node means that the node is stopped and not running. Once you will start it, the node will change to one of the running states below.



A grey node with an exclamation mark inside a triangle below the node means that there was a problem during the boot process, this could be a corrupted boot image, insufficient resources or problems with the initial configuration. A node in this state cannot be started again.

Workaround: Right-click on the node and wipe it, the symbol will then change to a grey colour with a square symbol below it. Then edit the node and make sure you have configured sufficient resources and the correct settings for this node, if it has startup-configs you can check them as well. Afterwards start the node again.

8.3.2 Running nodes



The blue color and black Play triangle symbol means that the node is started and running, the node is in a working/functional state.



A running node with a clock symbol below the node means that the node is waiting to finish loading from the set exported/startup configuration. Once the configuration has been successfully applied, the node symbol will change to a Play triangle symbol. If the node has finished booting but the clock symbol does not change to the Play triangle symbol, the problem could be in the uploaded startup configuration. For how to use exported configurations and boot nodes from them, please refer to section **11.1**



A running node with a turning red gear symbol means that the node is either in the process of hibernating the node or it has sent the shutdown signal to the node and is waiting for it to turn off. Once this process has successfully finished, the symbol will turn into a grey node with a black square symbol below it (stopped state).

⚠ NOTE: If the node does not support a system shutdown or does not recognize the shutdown signal (example: Cisco router), after clicking on Shutdown, the node can

stay with a turning red gear symbol below it indefinitely.
Workaround: Use Stop or Stop/PowerOff to stop the node.

Example nodes where Stop/Shutdown is supported: Microsoft Windows and most Linux nodes as well as a lot of appliances based on linux.

8.3.3 Node connector symbol

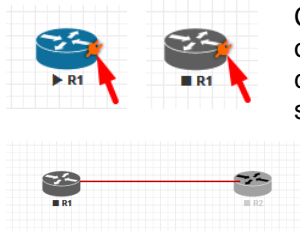

Connector symbol: If you move your mouse pointer on top of a running or stopped node, an orange connector symbol appears. It is used to connect nodes on the topology in a drag and drop style. Drag the symbol from one node and release the mouse pointer on the second node. A new window will appear where you can select the interfaces the link should connect to.

8.4 Other

8.4.1 Notifications area



The Notification area in the top right is displaying informational or error messages.

Unwrapped notifications:

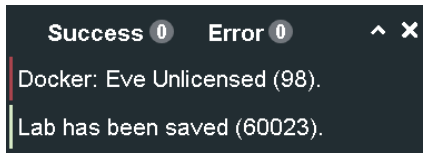

The Notification messages bar appears automatically for any EVE-PRO activity made on Topology.

	<p>Success message counter. For review, click on green ball to unwrap notifications. To wrap notifications, click to the ball again or click at any point of topology</p>
	<p>Error message counter. For review, click on red ball to unwrap notifications. To wrap notifications, click to the ball again or click at any point of topology</p>
	<p>Unwrap or wrap notifications bar.</p>
	<p>Close notifications bar. Note: Notifications bar appears automatically on any EVE topology activity.</p>

9 Working with EVE labs

⚠ IMPORTANT NOTE: You must prepare and upload at least a couple of images to start building your labs. Refer to section [17](#)

9.1 Creating a lab

Step 1: Click Add new lab. For more information on creating new labs, please refer to section [7.2.2.1](#)

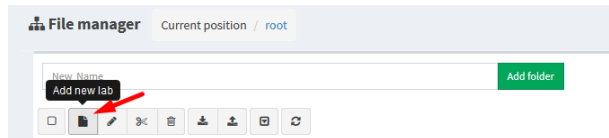

Step 2:

Fill out the lab information. Name and Version are required fields. Next hit Save. Refer to section [7.8.4](#) for more information about the different fields in the Edit lab window.

The 'Add New Lab' form contains the following fields and content:

- Name:** mylab4 (with a note: 'Use only [A-Za-z0-9_].chars')
- Version:** 1 (with a note: 'Must be Integer (0-9)chars')
- Author:** John Tester
- Config Script Timeout:** 300 Seconds
- Lab Countdown Timer:** 0 Seconds
- Description:** It is my new lab
- Tasks:**
 1. configure IP addressing
 2. configure EIGRP AS 20
 3. configure static default route to the Internet

Buttons for 'Save' and 'Cancel' are at the bottom right. A note at the bottom left indicates '* - Required Fields'.

9.1.1 Adding nodes to the lab

The new Topology page will open. There are two different ways to add nodes to the topology canvas:

Step 1: Object/Add Node

<p>Left Side Bar > Add object > node. Refer to section 8.1.1.1 for more information.</p> <p>The screenshot shows a dark sidebar menu with 'Add object' expanded. A red arrow points to the 'Node' option, which is highlighted. Other options include No, Network, Ne, Picture, St, Custom Shape, Co, Text, More actions, and Refresh topology.</p>	<p>Right click on a free area of the topology page and click on "Node" to add a new node. Refer to section 8.2.1 for more information.</p> <p>The screenshot shows a context menu titled 'Add a new object' with a red arrow pointing to the 'Node' option. Other options include Network, Picture, Custom Shape, Text, and Auto Align.</p>
---	---

Step 2: The Add new node window will appear. You can scroll down to choose which node you wish to add to the lab topology, or you can type the node name to filter through the node list.

! **NOTE:** It will only be possible to select and add nodes that have images preloaded in EVE. These nodes will be displayed in a blue font. To prepare images for EVE, refer to section 0

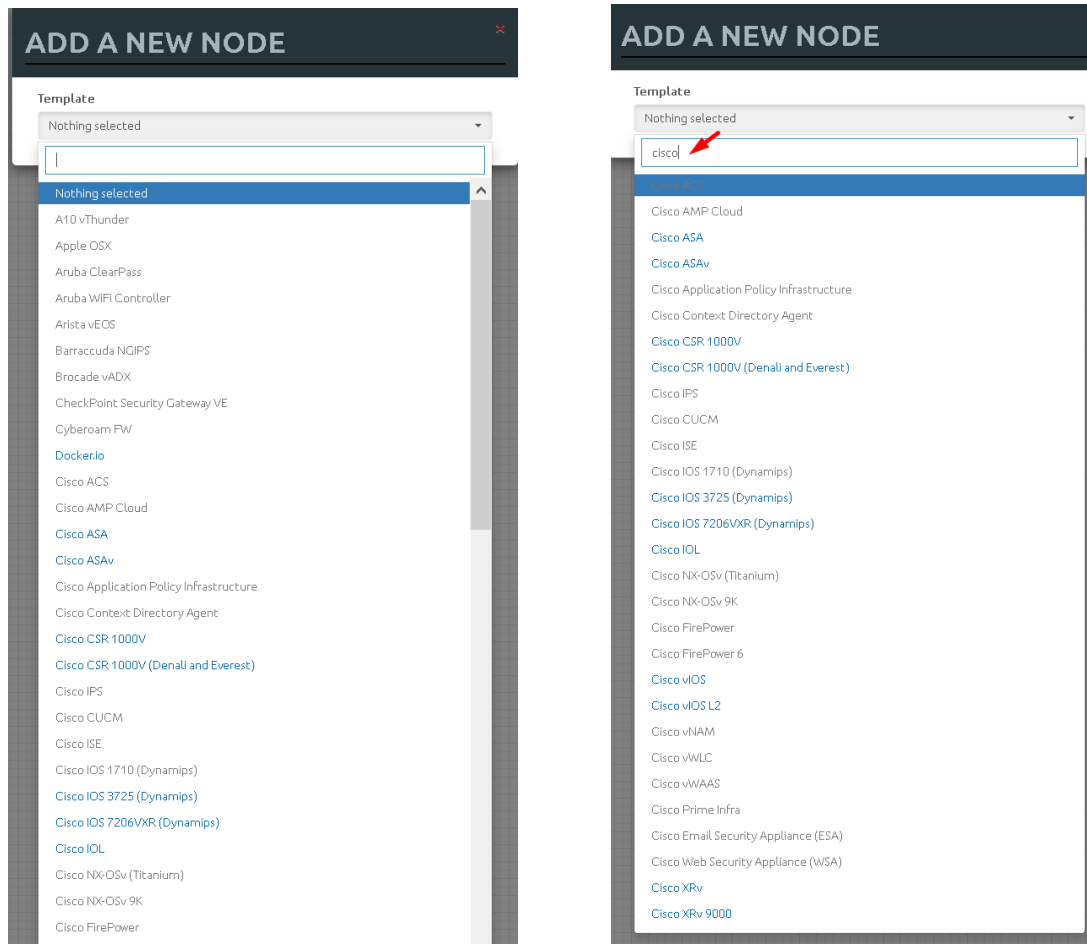

Step 3: Edit “Add a new node” settings. Please refer to the picture and table below.

ADD A NEW NODE ✕

Template 1.
Cisco CSR 1000V

Number of nodes to add 2. **Image 3.** csr1000v-universalk9.03.17.04.S.156-1.S4

Name/prefix 4.

Icon 5.
CSRv1000.png

UUID 6.

CPU Limit 7.

CPU 8. **RAM (MB) 9.** **Ethernets 10.**

QEMU Version 11. **QEMU Arch 12.** **QEMU Nic 13.**

QEMU custom options 14.

Startup configuration 15.
None

Delay (s) 16.



Console 17.
telnet

Left **Top**

Save Cancel

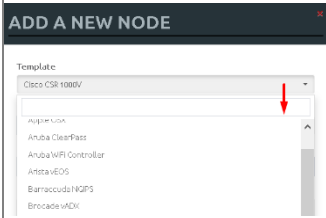
9.1.1.1 Node values Table

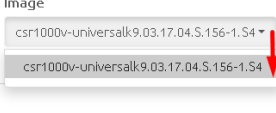
Number	Description
1.	 <p>Template menu. Choose which node template to add to the topology</p>

2.	Number of nodes to add <input type="text" value="1"/>	Chose the number of nodes of this type you want to add to the topology
3.	Image 	Choose your preferred version from preloaded images list (if you have more than one image loaded for a single template).
4.	Name/prefix <input type="text" value="CSR"/>	Type your preferred node name. If you are adding more than one, EVE will automatically append numbers to the nodes name. Example. We are adding 5 CSR nodes with the name R. On the topology they will appear as R1, R2, R3, R4, R5. Later using the the Nodes window, you can edit the node names per your needs. Refer to section 8.1.2 or edit the node individually, refer to section 9.1.2 .
5.	Icon 	Node icons can be changed from the default per your preference, simply choose the preferred icon from the dropdown list. Node icons can be changed later per your needs. Refer to section 8.1.2
6.	UUID <input type="text"/>	The UUID number is assigned automatically after a node is created. You may also set it manually in case you are using a license that is tied to a particular UUID.
7.	CPU Limit <input type="checkbox"/>	CPU limit per node. This option is already set (checked/unchecked) per EVE recommendations. Refer to section 7.4.3
8.	CPU <input type="text" value="1"/>	Each node template has a pre-set CPU value that aligns with vendor requirements. This value can be changed per your needs.
9.	RAM (MB) <input type="text" value="3072"/>	Each node template has a pre-set RAM value that aligns with vendor requirements. This value is displayed in MB and may be changed per your needs.
10.	Ethernets <input type="text" value="4"/>	The number of ethernets interfaces.

	<p>⚠ NOTE for IOL nodes:</p> <p>Ethernet interfaces for IOL nodes are placed into groups of 4. A value of 1 for Ethernet means your node will have 4 interfaces.</p> <p>The serial interface option is available for IOL nodes only and follows the same grouping structure as ethernet interfaces. A value of 1 for Serial means your node will have 4 serial interfaces.</p> <p>Ethernet portgroups (4 int each) <input type="text" value="1"/> Serial portgroups (4 int each) <input type="text" value="1"/></p>
11.	<p>Custom MAC address for Qemu nodes only. You can define your own MAC address for first interface:</p> <p>First Eth MAC Address</p> <p><input type="text" value="aa:bb:cc:00:de:ad"/></p>
12.	<p>QEMU Version</p> <p><input type="text" value="tpl(2.12.0)"/></p> <p>EVE will pre-set the best recommended QEMU version for each node template. This value can be changed per your needs.</p>
13.	<p>QEMU Arch</p> <p><input type="text" value="tpl(x86_64)"/></p> <p>Qemu architecture is pre-set per image vendor recommendations. This value can be changed per your needs</p>
14.	<p>QEMU Nic</p> <p><input type="text" value="tpl(vmxnet3)"/></p> <p>virtio-net-pci e1000 e1000-82545em vmxnet3 tpl(vmxnet3)</p> <p>Type of Qemu NIC is pre-set per image vendor recommendations. This value can be changed per your needs.</p>
15.	<p>QEMU custom options</p> <p><input type="text" value="-machine type=pc-1.0,accel=kvm -cpu Nehalem -serial mon:stdio -nographic -r"/></p> <p>Qemu custom options are pre-set per image vendor recommendations. This value can be changed per your needs</p>
16.	<p>Startup configuration</p> <p><input type="text" value="None"/></p> <p>Startup configuration: Value can be changed to set your node to boot from saved configurations. Refer to section 11.3 for more details.</p>
17.	<p>Delay (s)</p> <p><input type="text" value="0"/></p> <p>The Delay value is set in seconds and can be used to delay a node from booting after it is started. Example: if the value is set to 30, the node will wait 30 seconds before processing its boot sequense. This feature is useful in conjunction with the "Start all nodes" function if your lab requires certain nodes to start up before others or to avoid a mass-start of very heavy nodes.</p>

<p>18.</p>	<div style="display: flex; justify-content: space-between;"> <div style="width: 45%;"> <p>Console</p> <div style="border: 1px solid #ccc; padding: 2px; margin-bottom: 5px;">telnet</div> <p>The setting can be changes per your needs.</p> <p>⚠ NOTE: The Docker template contains a wide variety of images, therefore, please refer to section 14.1.3 for recommended console types for each docker image. Windows nodes can use either RDP or VNC but RDP needs to be enabled in Windows itself.</p> </div> <div style="width: 50%;"> <p>Console types for each template are pre-set with recommended settings.</p> </div> </div>
<p>19.</p>	<div style="display: flex; justify-content: space-between;"> <div style="width: 45%;"> <p>First Eth MAC Address</p> <div style="border: 1px solid #ccc; height: 20px; width: 100%;"></div> <p>manually set the MAC address for the first ethernet interface. This will enable the use of licenses that are tied to a particular MAC address.</p> <p>MAC Address format must be like: 00:50:0a:00:0b:00</p> </div> <div style="width: 50%;"> <p>OPTIONAL: Templates for Cisco FirePower, F5, Linux, and Citrix have the option to</p> </div> </div>

9.1.2 Edit node

EVE provides two ways to edit nodes after being added to the topology canvas.

⚠ NOTE: A node must be **wiped** each time an image or startup configuration has been changed.

9.1.2.1 Edit nodes globally

From the Topology page. Click “Nodes” from the left sidebar to bring up the nodes list. Refer to section [8.1.2](#) for more details.

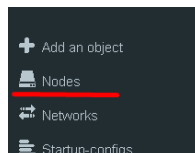

9.1.2.2 Edit node individually.

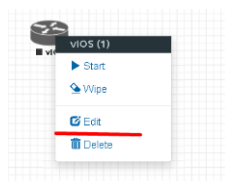

Right click on the node and click Edit

The “Edit node” window will appear. It is very similar to the window that is displayed when you add a new node. To change values for the node, refer to the nodes value table in section [9.1.1.1](#).

EDIT NODE ✖

Template
Cisco vIOS

ID
1

Image
vios-adventerprisek9-m-15.6.2T

Name/prefix
vIOS

Icon
Router.png

UUID
b5fa3320-98ed-4ea4-ad21-627d427b8a6a

CPU Limit

CPU 1	RAM (MB) 1024	Ethernets 4
-----------------	-------------------------	-----------------------

QEMU Version tpl(default 2.4.0)	QEMU Arch tpl(i386)	QEMU Nic tpl(e1000)
---	-------------------------------	-------------------------------

QEMU custom options
-machine.type=pc-1.0,accel=kvm -serial.mon:stdio -nographic -nodefconfig -nodef

Startup configuration
None

Delay (s)
0

Console
telnet

Left 839	Top 218
--------------------	-------------------

9.1.3 Wipe Node

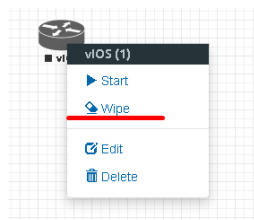

The “Wipe node” function will clear the NVRAM of the node. Each time a node setting is changed (CPU, RAM, boot image or startup configuration) a wipe must be issued on that node. For more information refer to section [11.3](#)

9.1.4 Interconnecting nodes

To connect nodes on the lab, use the drag and drop style method

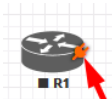
 Connector symbol: Moving the mouse over a node will make an orange male plug appear. The male plug is used to connect nodes on the topology, drag and drop style. Release the mouse pointer on the second node.



The connection window will appear. Choose the interface you want to use to interconnect the nodes. Click Save when finished.

ADD CONNECTION BETWEEN R1 AND R2



Source ID: 1
Source Name: R1
type - Node

Choose Interface for R1

Gi0/0

Gi0/0

Gi0/1

Gi0/2

Gi0/3

Gi0/0

Destination ID: 2
Destination Name: R2
type - Node

Save
Cancel

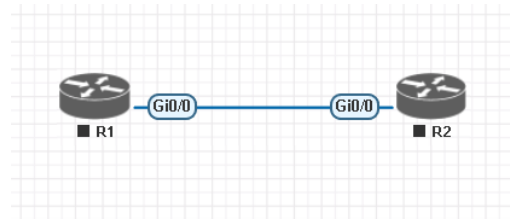

9.1.5 Edit connection link style

Right click on the connection link and choose Edit Style

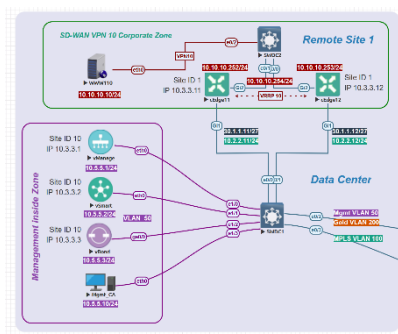
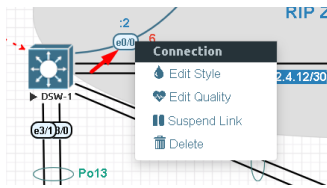

Straight link style

Style: network_id:25 Save Cancel

Style	Link color	Pos eth0	Pos eth1	Link Style	Link Label	Pos Label	Stub
Solid		+	+	Straight	VPN10	+	0

Bezier link style



Flowchart link style

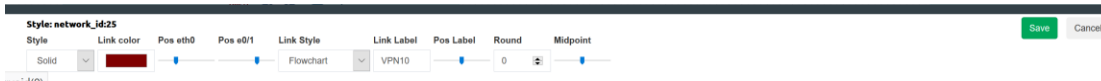

Style: Allows you to choose solid or dashed style for link. This can be edited later in the “Shape Edit” menu.

Link colour: Allows you to choose a colour for the link. This can be edited later in the “Shape Edit” menu.

Pos “interface” label: Allows move and position interface label

Link Style: Allows you to choose a style Straight, Bezier, Flowchart or StateMachine for the link. This can be edited later in the “Shape Edit” menu.

Link label: Allows you to add a label on the link. This can be edited later in the “Shape Edit” menu.

Pos Label: Allows move and position Link label, position it on the link

Curviness: Link curviness feature for Bezier style link

Midpoint: Link mid point change, Flowchart style only

Round: Link round angles, Flowchart style only

Stub: Stub link connection beside node, Straight style only

For edit Link style use mouse right click on link to call out link style editor.

9.1.6 Edit connection link quality

Right click on the connection link and choose Edit Quality. This function will allow apply on live connection Delay in ms, Jitter in ms, Packet loss in % and rate in kbs.

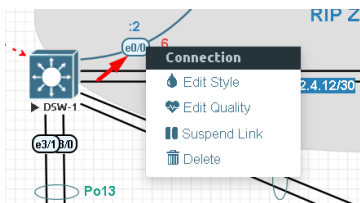

It is recommended to apply value divided by 2 on both link interfaces to achieve precise connection quality. In the example below is applied 25% and 25% packet loss, which gives result of 50% packet loss in connection between nodes.

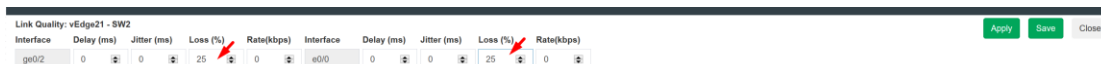

9.1.7 Suspend or resume link connection

The EVE-Pro has integrated feature to detect connection state on the interface.

Right click on the connection link and choose Suspend Link. This function will suspend connection between the two nodes. Literally, it will act like disconnected cable from the node, and interface will detect it as no connection. Suspended link will be marked with red dots.

To resume link connection, right click on the link connection and choose Resume Link

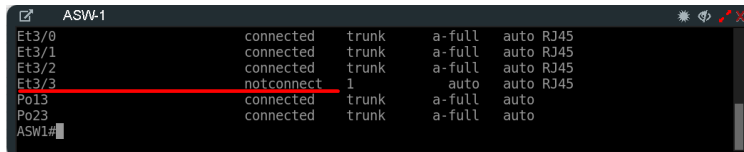
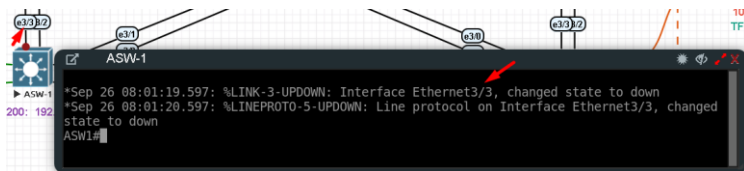
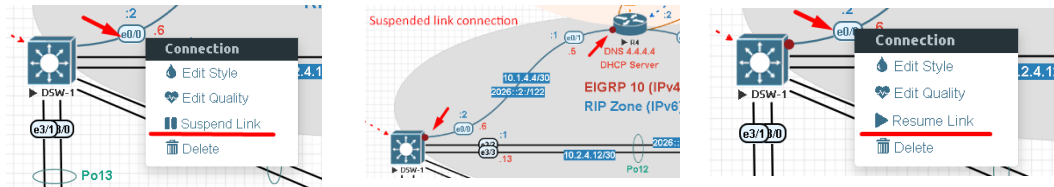

Supported nodes with suspend/resume feature:

Supported nodes for Link Suspend/resume	Not supported
IOL vIOS XRv9K CSR CSR SD-WAN ASA v Firepower FTD Juniper vSRX 12.1X47 Juniper vSRX NG Juniper vMX VCP/VFP Juniper VRR Nokia Timos SR 19.5.1 Windows All Linux All Apple OSX Mikrotik Palo Alto F5 Fortigate Checkpoint Cumulus Cyberoam FW Sophos FW SonicWall FW Viptela Velocloud Versa Networks sd-wan pfSense Brocade vADX Barracuda NGFW HP VSR1000	Arista NXOS 9k ASA ported XRv Old Juniper vMX Juniper vQFX Dynamips Titanium Nexus 7.x

⚠ NOTE: Avoid use Link suspend feature if you have configured:
 IOL L3 router image with:
 If the IOL L3 node interface is configured as DHCP client (ip dhcp), IOL node is attempting to bring up interface in up/up state. If you have enabled Link suspend feature on such configured interface, the node will flap link connection up/down/up.
 Same behave is observed if your Serial interface is configured with PPP encapsulation.

Other observations:

vIOS L2 image has minor internal issue. LACP protocol does not detect interface state as down/down

9.1.8 Delete connection between nodes

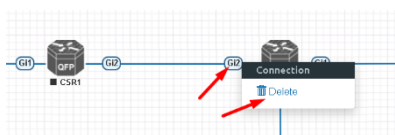

To delete a connection, right click on it and hit “Delete.”

9.1.9 Delete Node

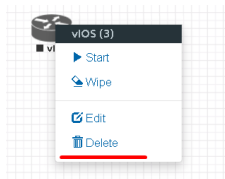

To delete a node, right click it and hit “Delete.” This is a non-reversible function

NOTE: It is strongly recommended to delete connections from a node before deleting the node itself.

9.2 Running labs

9.2.1 Starting lab

Nodes inside a lab may be started individually, in groups, or all at once.

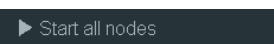

The Start all nodes option will start all nodes on your topology.

⚠ IMPORTANT. Starting all the nodes at once can result in major spikes in CPU utilization. Please make sure you are not using the “Start all nodes” option for heavy labs. Instead, it is recommended to start nodes in small groups.

Starting a node or group of nodes:

Right click on single node or node group and hit “Start.”

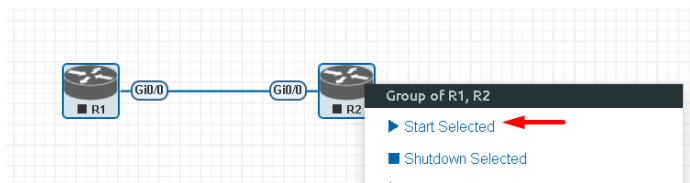
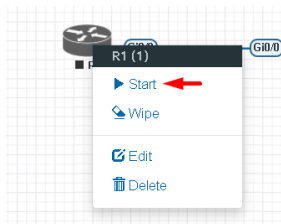

Running nodes will turn blue. Refer to section 8.3 for node states

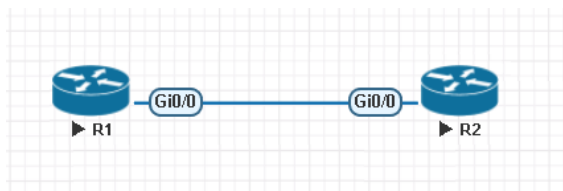

9.2.2 Interconnecting running nodes (hotlinks)

Eve Professional offers the hotlinks feature which allows you to interconnect node in the running state.

 Connector symbol. Moving the mouse over a node will make an orange male plug appear. The male plug is used to connect nodes on the topology, drag and drop style. Release the mouse pointer on the second node



ADD CONNECTION BETWEEN R1 AND R2



Source ID: 1
Source Name: R1
type - Node

Choose Interface for R1

Choose Interface for R2

Destination ID: 2
Destination Name: R2
type - Node

Save Cancel

9.2.3 Link quality delay, packet loss, jitter and rate feature

Please refer to Section [9.1.6](#)

9.3 Saving labs

To save a running lab, refer to the vendor recommended save commands for each node.

Example:

Cisco: "copy run start"

Juniper "commit"

Your current work will be saved in the nodes' NVRAM and the lab can be stopped safely. Starting the lab again will allow you to pick up from where you left off.

⚠ WARNING: Using the wipe action on a node will clear its NVRAM. This is similar to doing a factory reset on a device.

The configurations of nodes can be exported and used as initial or startup configurations for your labs. To export configurations and configuration sets for labs refer to section [11.1](#)

9.4 Stopping labs

■ Stop all nodes

The Stop all nodes option will stop all nodes on your topology.

NOTE: It is recommended to save your running configurations before you stop your nodes.

Stopping a node or group of nodes:

Right click on single node or node group and hit "Stop."

For individual node Stop options refer to section [8.2.5](#)

9.5 Start saved lab

Select the lab you want to start and click “Open”. To start Lab refer section [9.2.1](#)

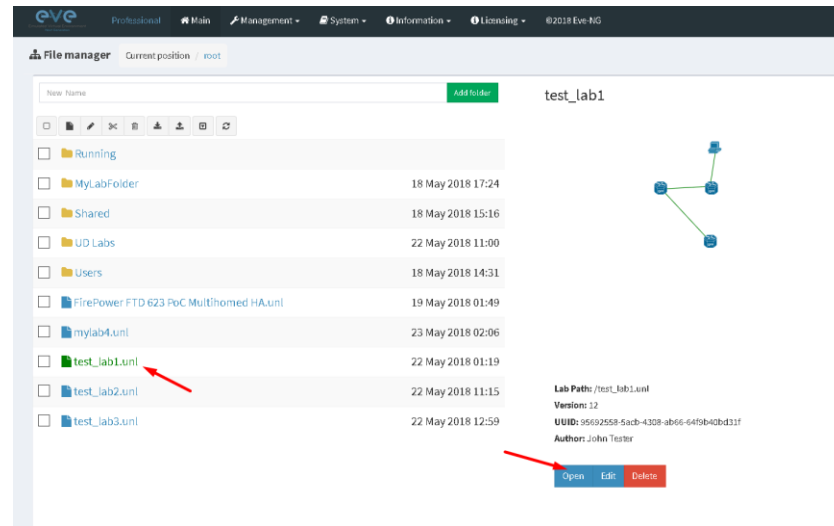

9.6 Working with multiple running labs

Refer to section [7.2.1.1](#)

9.7 Importing labs

Refer to section [7.2.2.6](#)

9.8 Exporting labs

Refer to section [7.2.2.5](#)

9.9 Deleting labs

Refer to section [7.2.2.2](#)

9.10 Moving labs

Refer to section [7.2.2.4](#)

9.11 Shared Project/Lab

EVE-NG provide an option to share single running lab between users. It is designed to run single lab for many users who can participate in lab session and configure it.

Note: Lab sharing option can be used between any of EVE NG User roles.

- ✓ Administrator can share lab for other Administrators, Lab Editors or Lab Users.
- ✓ Lab Editor can share lab for Administrators, other Lab Editors or Lab Users

- ✓ Lab User can share lab for Administrators, Lab Editors or other Lab Users.

9.11.1 Create Lab share

Step 1. Navigate to EVE main Lab tree and select which lab you want to share with others

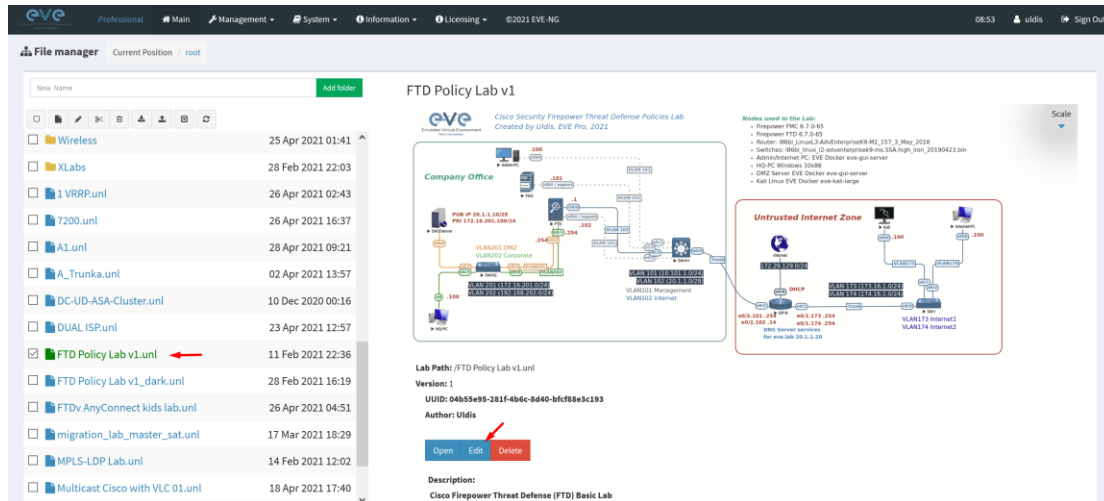

Step 2: From menu “Shared with” select Users to whom you want to share lab

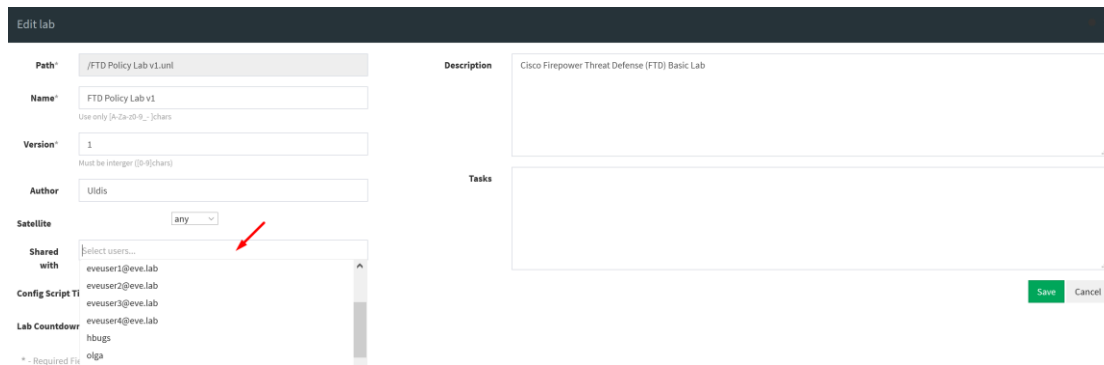

9.11.2 Remove Lab share

Note: Only owner of lab share can remove sharing.

Step 1. Navigate to EVE main Lab tree and select shared and click “Edit”

Step 2: Remove users from Shared with

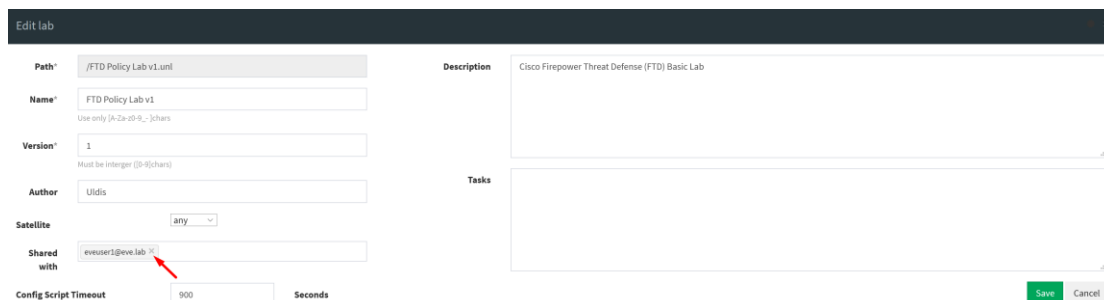

9.11.3 Working with shared lab

Step 1: Owner of shared lab starts the lab.

Step 2: Other user to whom this lab is shared, log into EVE with his account

Step 3: Open Shared Lab folder, the lab shared to him will appear as shared lab with owner user in brackets.

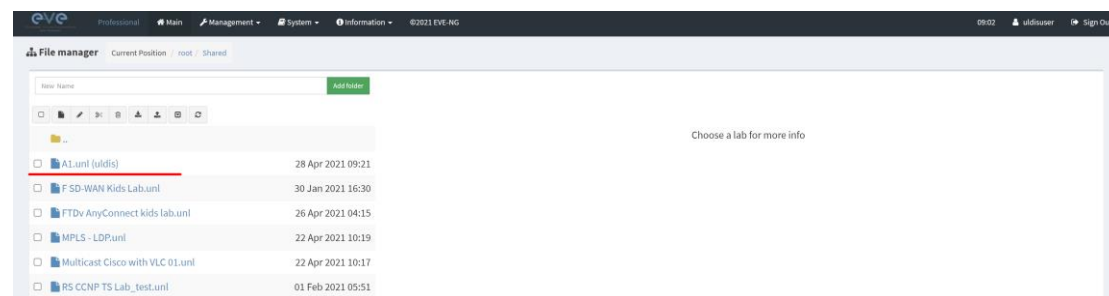

Accordingly, permissions of user roles:

- ✓ Administrator can start, stop or edit lab.
- ✓ Lab Editor can start, stop or edit lab.
- ✓ Lab user can start and stop lab

When you join in the shared lab, on the top of left side bar menu, you will notice the name of lab owner.

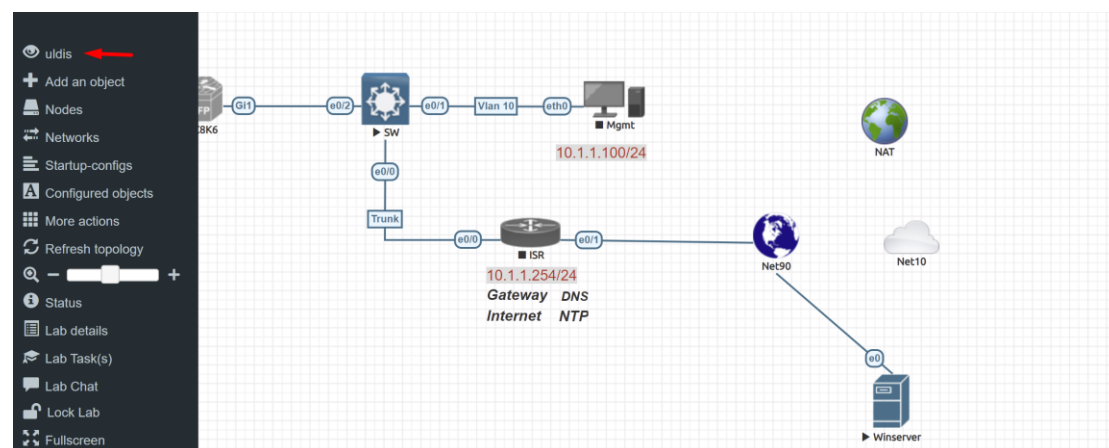

Note: If the Lab is been edited by Administrator, changed links connections or nodes, other shared lab users must refresh this lab topology to obtain changes.

Note: Parallel Consoles

Telnet Consoles: can be opened parallelly for any user

VNC Console: can be opened parallelly for any user

RDP Console: Only one user at same time can use RDP console to the node

9.12 Sticky lab

Pre-requisites for this feature: For Lab selection from the list, the Lab must be upload in the **Shared folder** by admin first. If Lab Menu is selected to “None”, User can close the Lab and open another shared Lab for him.

Applies for User role only. Set the specific Lab for the user “sticky lab”. After login in the EVE User will directed only to this lab. He cannot close the lab to get in main management page. User can Start/Stop/Wipe lab, as well save his lab work on the lab devices. Follow Section: **7.3.1.5**

The screenshot shows the 'Edit User' configuration page. The 'Lab' dropdown menu is open, displaying the following options: 'None', '/Shared/A1.unl', '/Shared/F SD-WAN Kids Lab.unl', and '/Shared/RS CCNP TS Lab_test.unl'. A red arrow points to the selected option, '/Shared/RS CCNP TS Lab_test.unl'. The 'User Name' field contains 'stud01'. The 'Password' and 'Password Confirmation' fields are masked with dots. The 'Email' field contains 'stud01@eve.net'. The 'Name' field contains 'Student 01'. The 'Role' is set to 'Lab User'. The 'Console' is set to 'html5'. The 'Satellite' is set to 'sat1'. The 'Account Validity' section shows 'From' as '-1' and 'to' as '0'. The 'POD' field contains '5'. The 'Quotas' section shows 'CPU' as '-1' and 'RAM (GB)' as '-1'. There are 'Edit' and 'Cancel' buttons at the bottom.

10 EVE Clouds and Networks

10.1 Bridge Network

The EVE Bridge interface acts like an unmanaged Switch. It supports passing along tagged dot1q packets.

Example: We have to connect many nodes in a flat (dot1q) network

Step 1: Add a Bridge Network onto the topology. There are two ways to do this: Right-clicking on the topology area and selecting “Add Network” or in the sidebar click “Add an Object” and then select “Network.” Please refer to sections [8.2.3](#) and [8.1.1.2](#)

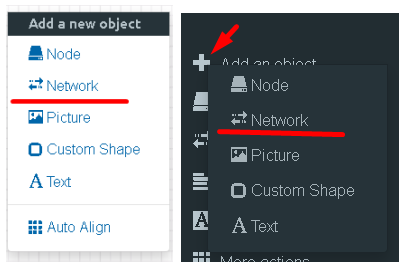

Step 2: Name/prefix can be changed in order to rename your Bridge network. Make sure your network type is set to bridge.

ADD A NEW NETWORK ✖

Number of networks to add:

Name/Prefix:

Type:

Left:

Top:

Step 3: Connect your nodes using the drag and drop connector. Refer to sections [9.1.4](#) and [8.2.3](#)

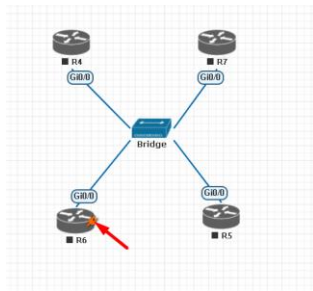

Step 3: Connect your lab node to Private cloud. Your connected nodes in Lab1 and Lab2 will work like being connected to the same network. CDP works. It is convenient if it is necessary to have connections across the multi labs.

⚠ NOTE: Using Private cloud, avoid to connect nodes with same ID to it. It will raise MAC address collision in your connection. Pic below shows correctly interconnected Node ID1 in Lab1 and Node ID5 in Lab2.

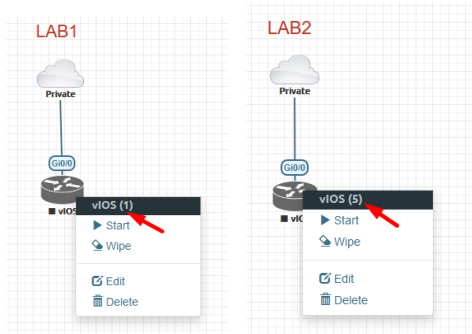

10.4 NAT Network

EVE-NG PRO has an embedded NAT interface with the subnet 172.29.129.0/24. This feature is similar to the VMWare NAT interface, but EVE is translating the 172.29.129.0/24 (this subnet is hardcoded in EVE and is not configurable) subnet to EVE's management interface pnet0.

To add a NAT Cloud onto the EVE topology:

ADD A NEW NETWORK

Number of networks to add:

Name/Prefix: ←

Type: ←

Left:

Top:

Step 1: Add A New Network onto the topology. There are two ways to do this: Right-clicking on topology area and selecting "Network" or in the sidebar, "Add an Object" and then select "Network."

Step 2: Name/prefix can be changed in order to rename your NAT network. Make sure your network type is set to NAT.

Step 3: Connect your nodes using the drag and drop connector. Refer to sections [9.1.4](#) and [8.2.3](#)

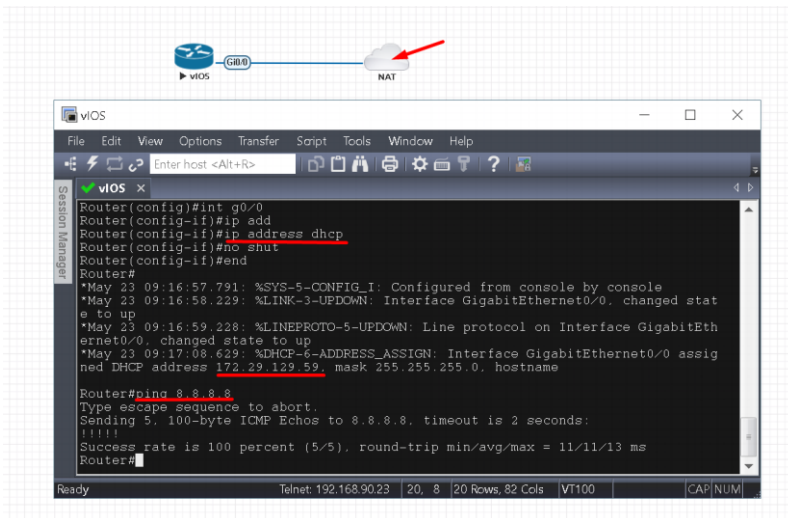

If your EVE management is connected to the Internet, adding a NAT cloud onto the EVE lab enables you to have internet access from within your EVE lab using NAT.

EVE NAT Gateway IP is:
172.29.129.254/24

DHCP is enabled on the EVE NAT Cloud.

10.5 Management Cloud0 interface

EVE management interface is also known as the Cloud0 network for labs. The Cloud0 interface is bridged with your EVEs first NIC. “Cloud” is used as an alias to pnet. Pnet is the bridge interface name inside of EVE.

```
# The primary network interface
interface eth0 inet manual
auto pnet0
interface pnet0 inet dhcp
bridge_ports eth0
bridge_stp off
```

Cloud0 is commonly used inside EVE labs to get management access to nodes running inside EVE from a host machine external to EVE.

- ⚠ **IMPORTANT NOTE:** For EVE VMs running on ESXi, make sure you are NOT using vSwitch NIC Team option. Only single Uplink is in use.
- ⚠ **IMPORTANT NOTE:** For EVE VMs running on ESXi, make sure your management interface bridged with the vSwitch (Port group) has the security settings set to Accept. Any port group or vSwitch used to connect an external network to an EVE Cloud network needs to have the:

- ❖ Promiscuous mode: “Accept”
- ❖ MAC Address changes: “Accept”
- ❖ Forged transmits: “Accept”

vSwitch Settings

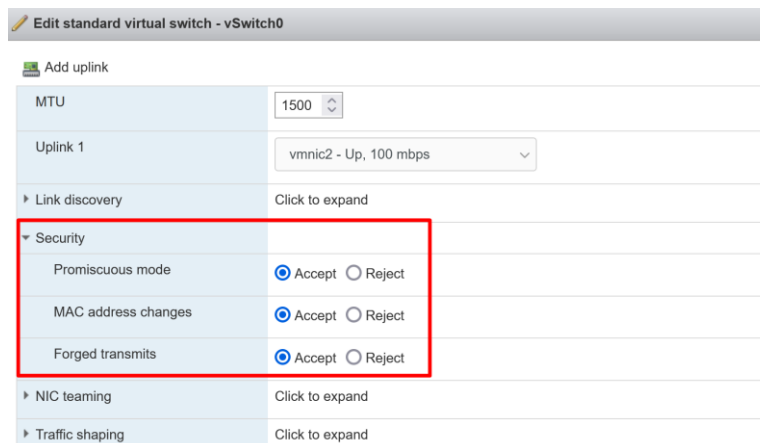

Portgroup Settings

The screenshot shows the Management 90 UD interface. On the left, the vSwitch topology is displayed, showing a list of virtual machines connected to the vSwitch. The physical adapters section shows 'vmmnic1, 100 Mbps, Full'. On the right, the Security policy, NIC teaming policy, and Shaping policy are listed.

Security policy	
Allow promiscuous mode	Yes
Allow forged transmits	Yes
Allow MAC changes	Yes

NIC teaming policy	
Notify switches	Yes
Policy	Route based on ori
Reverse policy	Yes
Rolling order	No

Shaping policy	
Enabled	No

EVE Cloud0 bridging table.

Lab name	EVE interface name (inside)	Type	Notes
Cloud0	pnet0	Bridged	Cloud0/pnet0 is bridged with your primary EVE ethernet port. It is assigned a management IP address used for WEB GUI access. The EVE management subnet can be used as a management network in labs.

⚠ Question: How can I obtain my Cloud0 subnet and gateway IP. Many EVE VMs only have a DHCP address assigned on the pnet0 interface.

Answer: SSH to EVE and type the following from the CLI:

```
route
root@eve-ng:~# route
Kernel IP routing table
Destination Gateway Genmask Flags Metric Ref Use Iface
default 192.168.90.1 0.0.0.0 UG 0 0 0 pnet0
172.17.0.0 * 255.255.0.0 U 0 0 0 docker0
172.29.129.0 gateway IP type: 255.255.255.0 U 0 0 0 nat0
192.168.90.0 * 255.255.255.0 U 0 0 0 pnet0
root@eve-ng: #
```

Example: We want to use Cloud0 as a management network for an ASAv node in an EVE lab. From the above-obtained information, we know that our Cloud management subnet is 192.168.90.0 with a mask of 255.255.255.0 and the Gateway IP is 192.168.90.1.

ADD A NEW NETWORK

Number of networks to add:

Name/Prefix:

Type:

Left:

Top:

Step 1: Add A New Network onto the topology. There are two ways to do this: Right-clicking on topology area and selecting “Network” or in the sidebar, “Add an Object” and then select “Network.”

Step 2: Name/prefix can be changed in order to rename your Cloud0 network. Make sure your network type is set to Management(Cloud0).

Step 3: Connect your ASAv using the drag and drop connector to the Cloud0 network. Refer to sections [9.1.4](#) and [8.2.3](#)

Step 4: Start the node and configure the interface connected to Cloud0 with an IP address from the management subnet (192.168.90.0/24 in this example). Make sure you do not assign duplicate IPs.

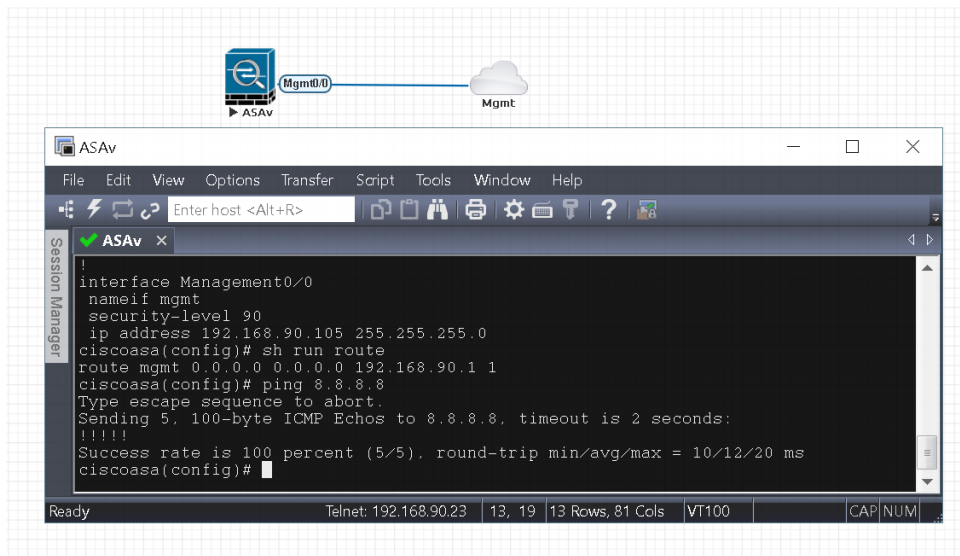

The native management host (home PC) can be used to manage nodes in the EVE lab over https. Example below showing http connection to Fortigate FW node in the EVE lab from native PC using Chrome browser.

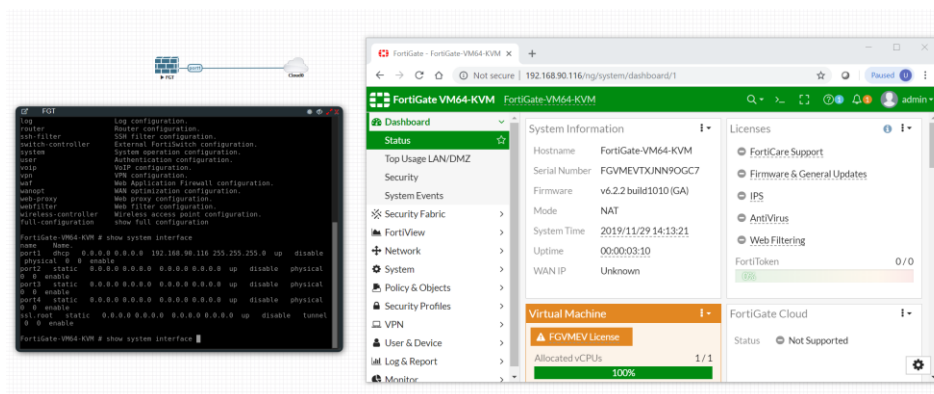

NOTE: Cloud interfaces can be used to connect multiple nodes to a single cloud instance on the topology.

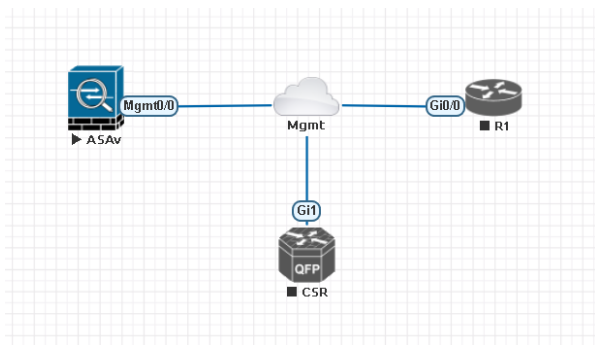

10.6 Remove cloud interfaces

For security reasons you can make cloud (Cloud0-9) interfaces invisible for the Lab Editors and Lab Users.

```
echo -n 1 > /opt/unetlab/natonly
```

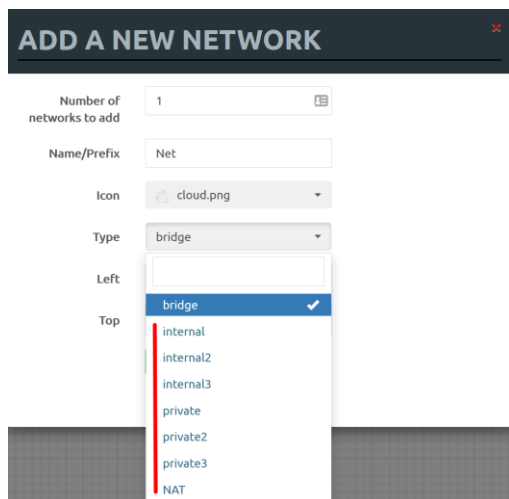

To set back Clouds0-9 visible:

```
echo -n 0 > /opt/unetlab/natonly
```

All Clouds 0-9 will remain visible for Admin users.

10.7 Other cloud interfaces

Other cloud interfaces can be used to extend a lab connection inside of EVE or bridged with other EVE interfaces to connect external networks or devices.

EVE Cloud bridging table.

Lab cloud name	EVE interface name (inside)	Type	ESXi VM corresponding interface	VMware Workstation corresponding interface	Bare HW Server	Notes

Cloud0	Pnet0	bridged	Network adapter 1	Network Adapter	First ethernet Eth0	Cloud0/pnet0 is bridged with your primary EVE ethernet port. It is assigned a management IP address used for WEB GUI access. The EVE management subnet can be used as management network in the labs.
Cloud1	Pnet1	bridged	Network adapter 2	Network Adapter 2	Second ethernet Eth1	Cloud1 can be bridged with your EVE second ethernet port to achieve connection to another network or device. The IP address is not required to be configured on it. It will act like a pure bridge your external connection with EVE lab node.
Cloud2	Pnet2	bridged	Network adapter 3	Network Adapter 3	Third ethernet Eth2	Same as Cloud1
Cloud3	Pnet3	bridged	Network adapter 4	Network Adapter 4	Fourth ethernet Eth3	Same as Cloud1
Cloud4-9	Pnet4-9	bridged	Network adapter 5-10	Network Adapter 5-10		Same as Cloud1

If some of the clouds (e.g. Cloud1) are bridged to another ethernet (VMnet) you can connect your EVE lab to an external VM or physical device (like e.g. a switch, IP phone or access point).

- ⚠ For ESXi make sure that you have set Promiscuous mode security settings on the vSwitch and Port group to Accept. Please refer to section [10.5](#)

The next sections will explain how you can use Cloud networks in EVE to connect to other external (e.g. VMWare) VMs or physical devices.

10.8 Connecting external VM machines to the EVE Lab

10.8.1 ESXi VM machines

External ESXi VM machines can be connected to EVE labs using cloud interfaces.

- ⚠ **NOTE:** A single Cloud interface can be used to connect more than one external VM to the EVE lab.

Example: Connecting a Web Security Appliance (WSA) to the lab using the Cloud1 interface.

Step 1: Create a new or use an existing portgroup on your ESXi and assign it to EVE and WSA VMs as shown below. Make sure you have set Promiscuous mode on the vSwitch (portgroup WSA-MGMT) to Accept.

⚠ NOTE: VM machines must be in a powered off state to assign network interfaces.

Portgroup WSA-MGMT (with vSwitch5 as parent) settings:

WSA-MGMT	
Accessible:	Yes
Virtual machines:	2
Virtual switch:	vSwitch5
VLAN ID:	0
Active ports:	0

vSwitch topology	
WSA-MGMT	No physical adapters
VLAN ID: 0	
Virtual Machines (2)	
EVE-PROV24	
coeus-10-1-3-039-S000V	

Security policy	
Allow promiscuous mode	Yes
Allow forged transmits	Yes
Allow MAC changes	Yes

NIC teaming policy	
Notify switches	Yes
Policy	Route based on originating port ID
Reverse policy	Yes
Rolling order	No

Shaping policy	
Enabled	No

Parent vSwitch5 settings:

vSwitch5	
Type:	Standard vSwitch
Port groups:	1
Uplinks:	

vSwitch Details	
MTU	1500
Ports	4352 (4319 available)
Link discovery	Unknown
Attached VMs	2 (0 active)

NIC teaming policy	
Notify switches	Yes
Policy	Route based on originating port ID
Reverse policy	Yes
Rolling order	No

Security policy	
Allow promiscuous mode	Yes
Allow forged transmits	Yes
Allow MAC changes	Yes

EVE and WSA VMs settings

<p>EVE VM, second port is assigned to portgroup WSA-MGMT. It is Cloud1 on the EVE topology.</p>	<p>Cisco Web security appliance (WSA), Management port is assigned in portgroup WSA-MGMT.</p>
---	---

Hardware Configuration		Hardware Configuration	
CPU	16 vCPUs	CPU	1 vCPUs
Memory	32 GB	Memory	4 GB
Hard disk 1	40 GB	Hard disk 1	250 GB
Hard disk 2	150 GB	Network adapter 1	WSA-MGMT (Connected)
USB controller	USB 2.0	Network adapter 2	UNUSED (Connected)
Network adapter 1	Management 90 UD (Connected)	Network adapter 3	UNUSED (Connected)
Network adapter 2	WSA-MGMT (Connected)	Network adapter 4	UNUSED (Connected)
Video card	4 MB	Network adapter 5	UNUSED (Connected)
Others	Additional Hardware		

EVE Lab connected to the WSA (Cloud1)

- ⚠ NOTE: ESXi WSA VM obtained the IP 192.168.10.3 from the DHCP pool on the lab switch. The gateway is 192.168.10.1
- ⚠ NOTE: The Firefox Docker node user for management obtained the IP 192.168.10.2 from the DHCP pool configured on the lab switch.

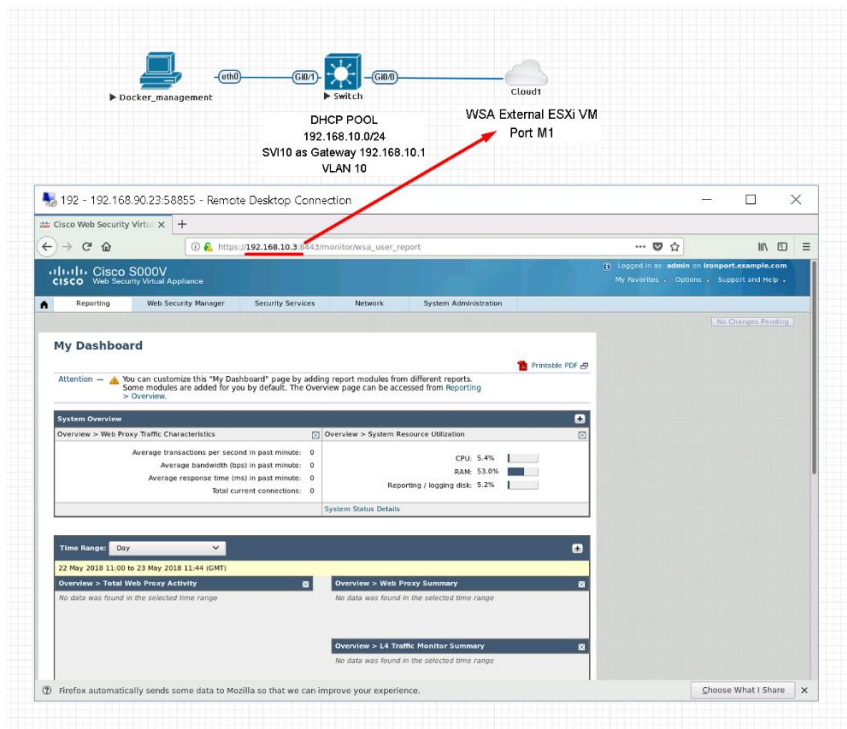

10.8.2 VMWare workstation machines

External (meaning not running inside EVE) VMWare workstation machines can be connected to EVE labs using cloud interfaces.

- ⚠ NOTE: A single Cloud interface can be used to connect more than one external VM to the EVE lab.

Example: Connecting Web security Appliance (WSA) to the lab using **Cloud2** interface.

- ⚠ NOTE: VMs must be in a powered off state to assign network interfaces.

Step 1: Open your VMWare Workstation Virtual Network Editor and configure the VMnet interface for the Cloud and WSA VMs. If necessary add a new VMnet. The example below is showing VMnet2 Settings in VMWare workstation. DHCP must be disabled for VMnet2.

Virtual Network Editor settings:

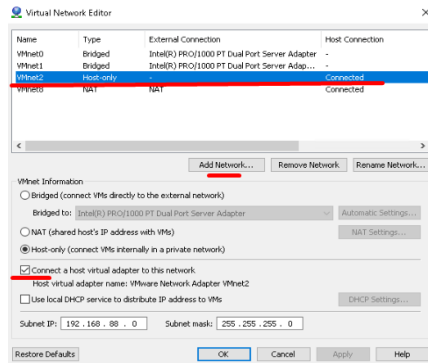

EVE and WSA VMs settings

EVE VM, the third port (Network adapter 3) is assigned to VMnet2. This is Cloud2 inside your EVE labs.

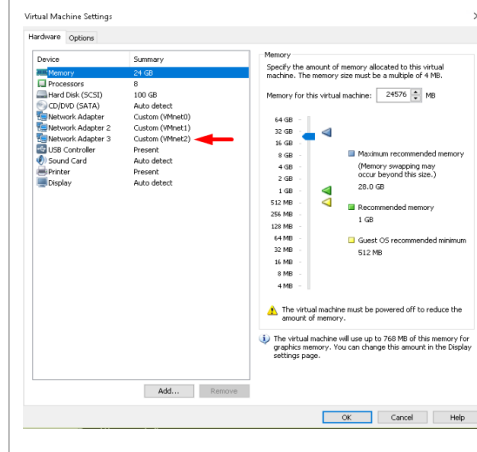

Cisco Web Security Appliance (WSA), Management port is assigned to VMnet2

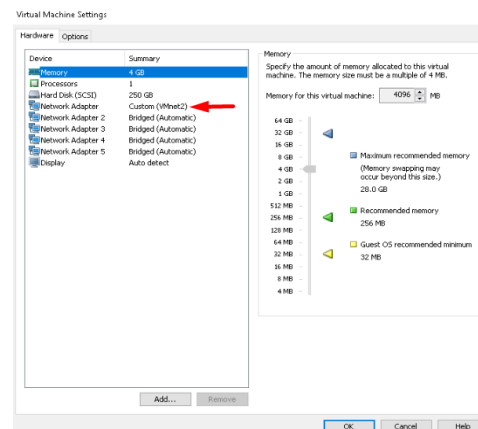

EVE Lab connected to the WSA (Cloud2)

- ⚠ NOTE: ESXi WSA VM obtained the IP 192.168.10.3 from the DHCP pool on the lab switch. The gateway is 192.168.10.1
- ⚠ NOTE: The Firefox Docker node user for management obtained the IP 192.168.10.2 from the DHCP pool configured on the lab switch.

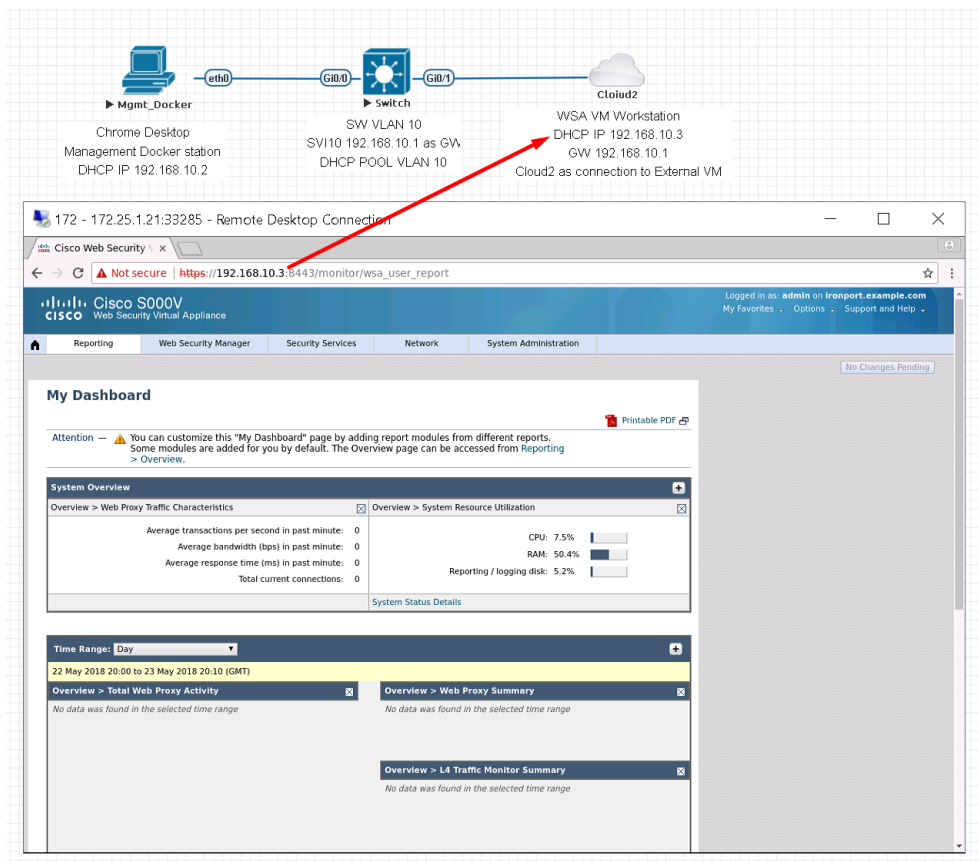

10.9 Connecting EVE Lab to a physical device

10.9.1 ESXi EVE

To connect a physical device (e.g. router, switch) to an EVE lab over a cloud interface, we have to bridge the ESXi NICs ethernet port to a VMnet interface.

- ⚠ **IMPORTANT NOTE:** Make sure that you have set Security Policy (Promiscuous mode, forged transmits and MAC changes) settings on the vSwitch and Port group to Accept.
- ⚠ **IMPORTANT NOTE:** If you are building trunk between EVE lab node to real Switch, please make sure you have set your ESXi vSwitch interface to accept all vlans. Reference: <https://kb.vmware.com/s/article/1004074>
- ⚠ **IMPORTANT NOTE:** Do not use NIC teaming for connection to the physical device. Reference: <https://kb.vmware.com/s/article/1004109>

The Example below is showing ESXi Server settings of the virtual network bridged to the physical interface.

[Logical chain of the networking bridge:](#)

EVE Lab Cloud0 → Portgroup “Management 90 UD” → vSwitch 1 → Physical Adapter eth1

vSwitch1 settings bridged with Server Ethernet port vmnic1 (physical adapter)

vSwitch1
Type: Standard vSwitch
Port groups: 2
Uplinks: 1

vSwitch Details

MTU	1500
Ports	4352 (4317 available)
Link discovery	Listen / Cisco discovery protocol (CDP)
Attached VMs	7 (4 active)
Beacon interval	1

NIC teaming policy

Notify switches	Yes
Policy	Route based on originating port ID
Reverse policy	Yes
Rolling order	No

Security policy

Allow promiscuous mode	Yes
Allow forged transmits	Yes

vSwitch topology

Management 90 UD
VLAN ID: 4095

Virtual Machines (7)

- vCentre 90.95
- S2016 EVE 90.201
MAC Address 00:0c:29:b0:c4:5b
- EVE-PRO.98.100
MAC Address 00:0c:29:d0:aa:8e
- EVE-PROv24
MAC Address 00:0c:29:3d:ae:b8
- EVE COMM 89
- Cisco Identity Services Engine
- ASAv 90.35 PROD
MAC Address 00:50:56:a7:79:f0

Physical adapters
vmnic1, 100 Mbps, Full

Portgroup “Management 90 UD” Settings associated with vSwitch1

Management 90 UD

Accessible: Yes
Virtual machines: 7
Virtual switch: vSwitch1
VLAN ID: 4095
Active ports: 5

vSwitch topology

Management 90 UD
VLAN ID: 4095

Virtual Machines (7)

- vCentre 90.95
- S2016 EVE 90.201
MAC Address 00:0c:29:b0:c4:5b
- EVE-PRO.98.100
MAC Address 00:0c:29:d0:aa:8e
- EVE-PROv24
MAC Address 00:0c:29:3d:ae:b8
- EVE COMM 89
- Cisco Identity Services Engine

Physical adapters
vmnic1, 100 Mbps, Full

Security policy

Allow promiscuous mode	Yes
Allow forged transmits	Yes
Allow MAC changes	Yes

NIC teaming policy

Notify switches	Yes
Policy	Route based on originating port ID
Reverse policy	Yes
Rolling order	No

Shaping policy

EVE VM Settings

EVE VM Cloud0 is connected to Portgroup “Management 90 UD”

Hardware Configuration	
CPU	16 vCPUs
Memory	32 GB
Hard disk 1	40 GB
Hard disk 2	150 GB
USB controller	USB 2.0
Network adapter 1	Management 90 UD (Connected)
Network adapter 2	WSA-MGMT (Connected)
Video card	4 MB
Others	Additional Hardware

EVE Lab Connected to a physical device

Physical Topology

Cisco 887M device port Fastethernet 3 is physically connected to Server port eth1.

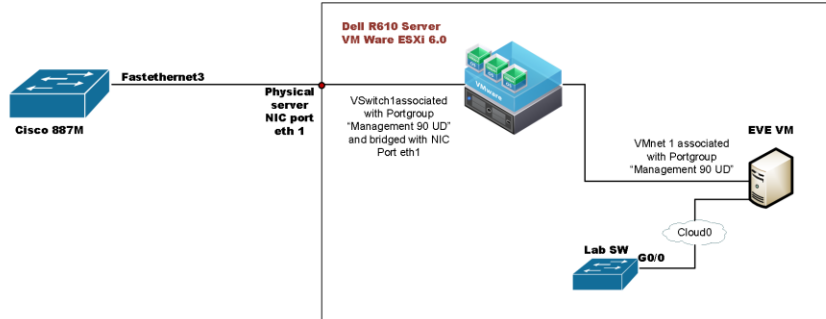

EVE Lab Topology

EVE lab switch port G0/0 is configured as trunk and connected to Cloud0 over bridged chain to the physical Cisco 887M Router switchport Fastethernet 3

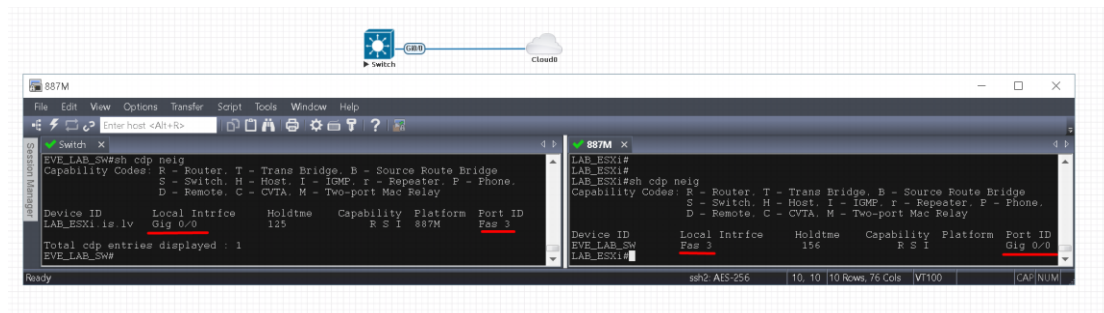

10.9.2 VMWare workstation EVE

Similar to the ESXi connection, it is recommended to have a second ethernet interface on your PC. It can be a USB ethernet extender as well. Not all ethernet adapters fully support a layer2 connectivity over it. MS Windows OS itself strips off any tags added to the packet. Even if your NIC supports 802.1q VLAN tagging, Windows 10 strips these tags off. The example below will show a Windows 10 host connected to a physical 3750G-24 switch. The Windows 10 Host has an Intel (R) PRO/1000 PT Dual port server adapter and is bridged with VMWare workstation (version 14) VMnets.

Virtual Network Editor Settings, Bridged VMnet interfaces with Real NIC Ports

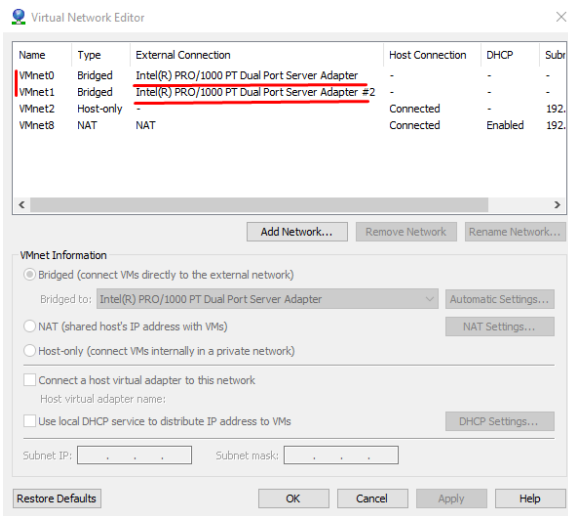

EVE VM Settings. Network adapter is bridged to VMnet0 (ethernet Intel Pro 1), and Network adapter 2 is bridged to VMnet1 (ethernet Intel Pro 2).

Responding cloud interfaces on EVE VM:

Cloud0→Network Adapter→VMnet0→IntelPro

Cloud1→Network Adapter 2→VMnet1→IntelPro#2

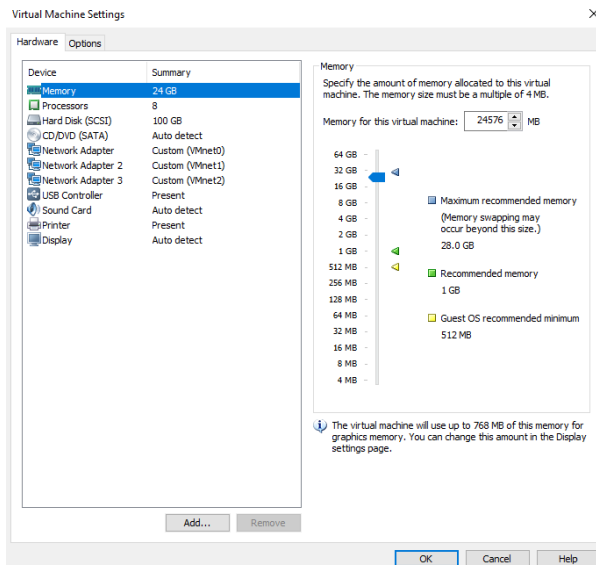

Physical connection scheme and VMware bridging.

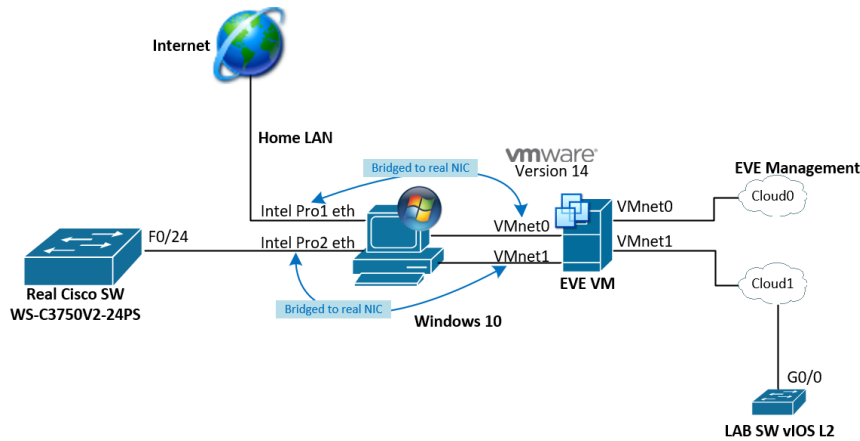

EVE Lab scheme.

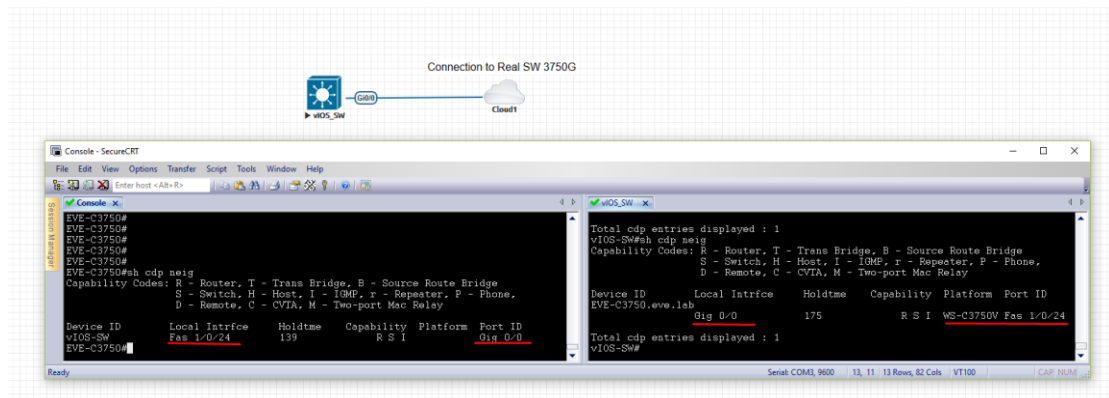

The following solution allows Windows hosts to transmit tagged packets over ethernet. This has been used in the example above.

- ⚠ Warning. You are making changes to your Windows registry files! This is at your own risk.

<https://www.intel.co.uk/content/www/uk/en/support/articles/000005498/network-and-io/ethernet-products.html>

10.9.3 Bare metal server EVE

A physical server usually has more than one ethernet port, free ports can be bridged with EVE clouds and used for external connections. EVEs internal interface settings are already bridged in order, pnet0-9 are mapped to eth0-9. Refer to the bridging table in section 10.6

```
cat /etc/network/interfaces
```

```
# Cloud devices
iface eth1 inet manual
auto pnet1
iface pnet1 inet manual
bridge_ports eth1
bridge_stp off

iface eth2 inet manual
auto pnet2
iface pnet2 inet manual
bridge_ports eth2
bridge_stp off
```

Basically, your servers physical port eth0 is bridged to pnet0 which is Cloud0 in your labs, eth1 is bridged to pnet1 which is Cloud1 in your labs (and so on). Refer to the bridging table in section 10.6

The example below shows how to connect a bare-metal EVE server with a physical Cisco 3750E switch.

Physical connection topology:

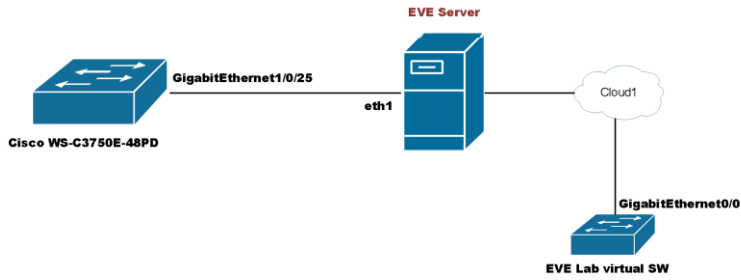

The EVE lab switch's CDP neighbor is the 3750E switch's port Gig 1/0/25: A trunk has been configured between the EVE lab switch and the physical 3750E switch.

```

Switch#sh cdp neig
Capability Codes: R - Router, T - Trans Bridge, B - Source Route Bridge
                  S - Switch, H - Host, I - IGMP, r - Repeater, P - Phone,
                  D - Remote, C - CVTA, M - Two-port Mac Relay

Device ID         Local Intrfce   Holdtme    Capability Platform Port ID
NottsCoreRackSwitch1 DataServices local
                  Gig 0/0         140        R S I   WS-C3750E Gig 1/0/25

Total cdp entries displayed : 1
Switch#
  
```

11 Advanced EVE Lab features

11.1 Lab design objects

EVE Pro has drawing elements integrates to add drawings and text information to the lab topology. Objects can be placed on the topology in two ways.

Example below, EVE lab with design elements:

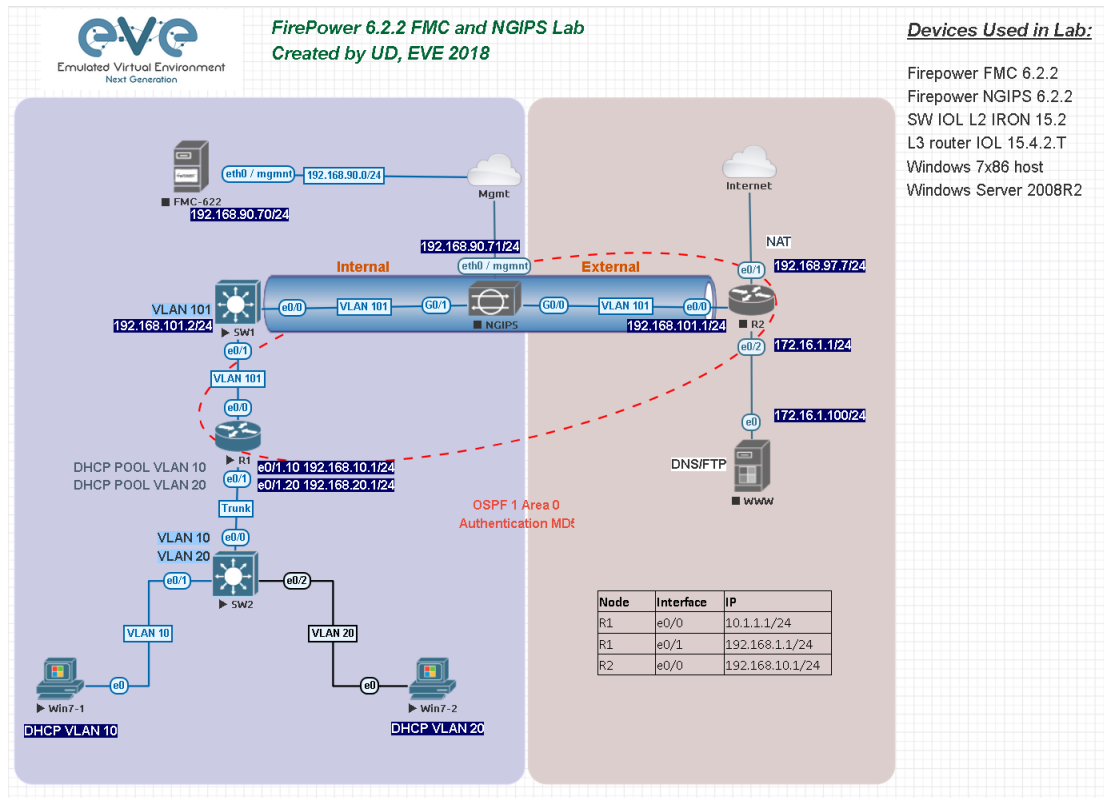

Option 1: Side bar -> Add an object

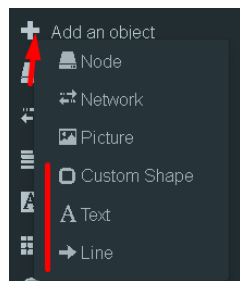

Option 2: Right-click on a free area on the topology canvas to add an object.

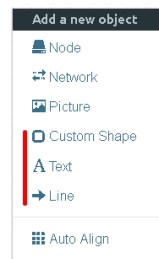

11.1.1 Custom shape

There are three custom shapes that can be added to the topology: square, round square and circle (sphere).

Type: Square, round square or circle

Name: This field can be filled with your preferred shape's name. If the field is left empty, EVE will generate a name for the shape.

Border type: Two options: line or dashed

Border width: Increase or decrease the width of the border. This can be edited later in the "Shape Edit" menu.

Border colour: Allows you to choose a colour for the shape's border. This can be edited later in the "Shape Edit" menu.

Background colour: Allows you to choose a colour to fill your shape with. This can be edited later in the "Shape Edit" menu.

Example: Added a circle and square on the topology. Shapes can be moved around the topology drag and drop style (click and move with mouse).

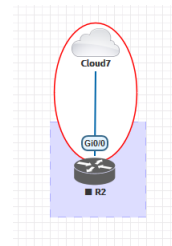

11.1.2 Resize square or circle objects

Move your mouse over the right bottom corner of the object until a corner symbol appears. Left click and drag your mouse to change object size or style (rectangle, sphere)

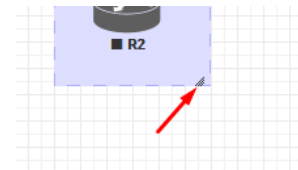

11.1.3 Text

It is also possible to add text or other MS Office objects to your EVE topology. Rich HTML Office option allows you to copy texts from MS Word, Excel or Visio.

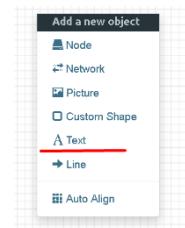

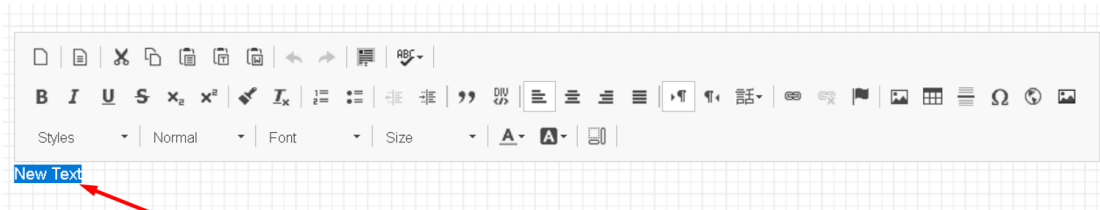

Your text. Can be copied from MS Office. Similar like in MS office you can edit this text here

Example: Excel table on topology:

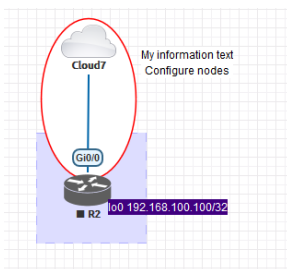
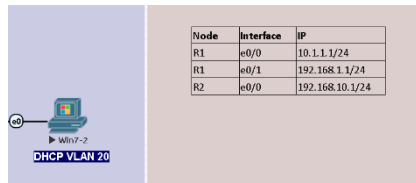

Example: text objects added to the topology.

Example: Visio object added to the topology

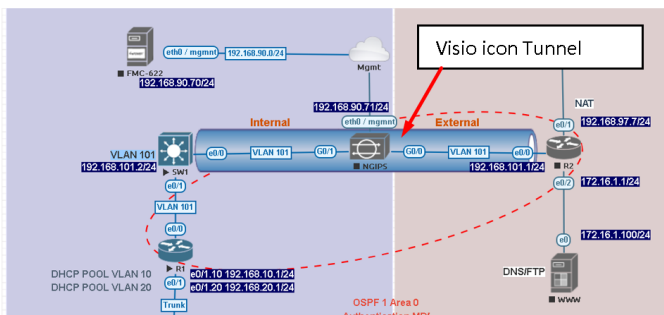

11.1.4 Add picture to the topology

Custom images may be added by using HTML editor:

Step 1: Add a text object to the topology and press Image button for import.

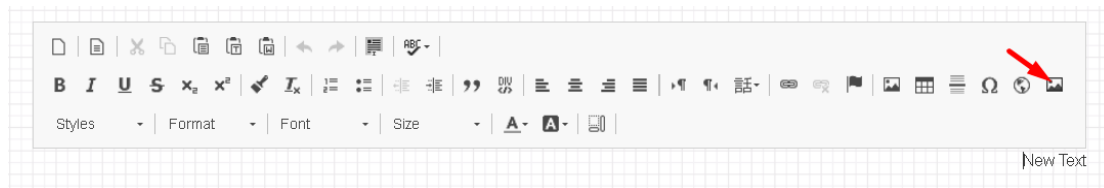

Step 2: User browse to import your image.

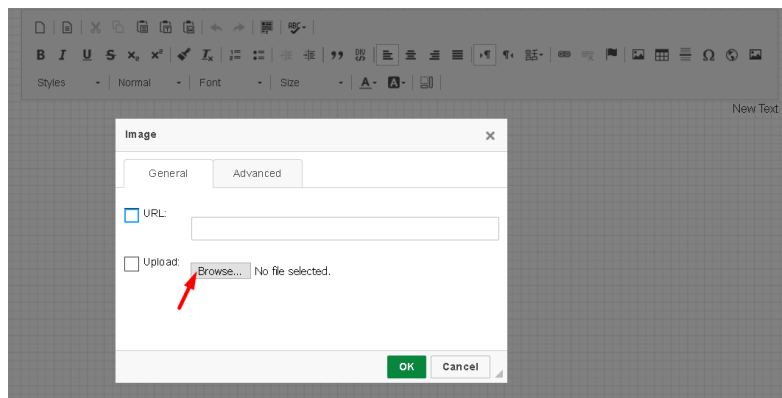

Step 3: Double click on object you wish to resize, then change width and height.

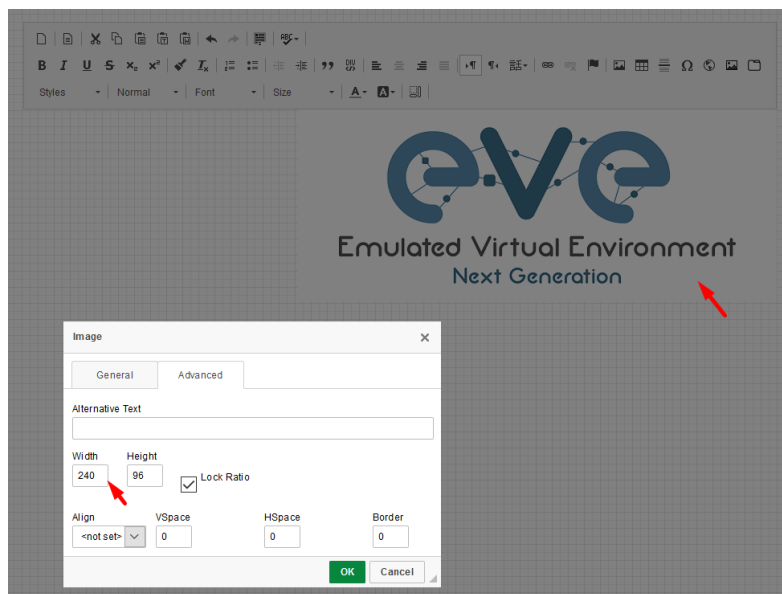

11.1.5 Custom object linking with telnet or other protocol

This feature allows you to link your eve topology object with external source. It can be web site or other protocol like Telnet to call out console for external object.

Step 1. Add the text or picture using HTML editor. Sections [11.1.3](#) or [11.1.4](#).

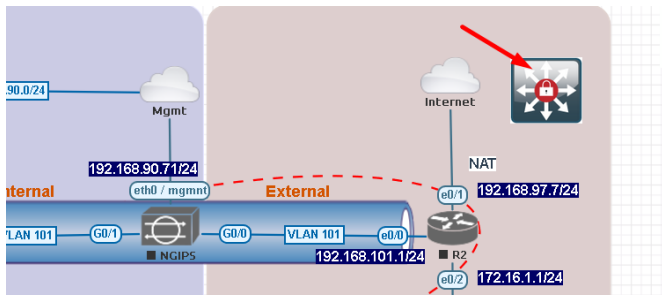

Example: Custom icon added from MS Visio.

Step 2. Position your object in place where you want it to be.

Step 3. Highlight text or activate object.

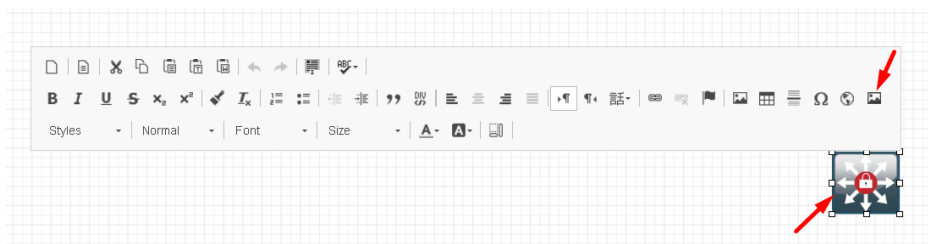

Step 4. Use link button to assign custom protocol for your object. Example: Protocol Other, type in URL: **telnet://10.1.1.10**

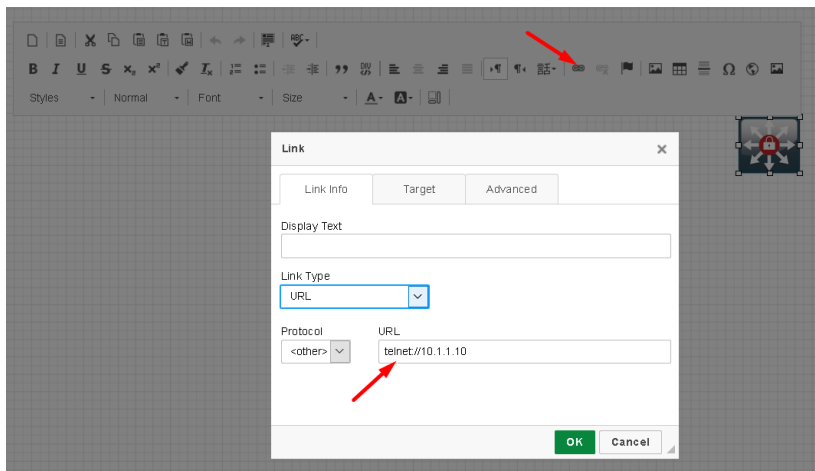

Step 4. Tab Target, Example: Target/New Window

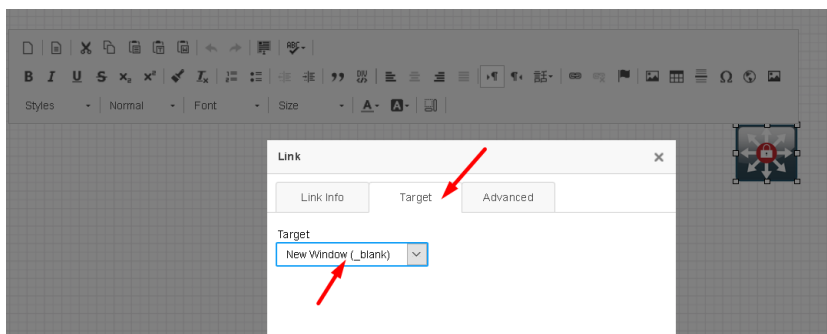

Step 5. OK for Save.

NOTE to edit picture object assigned with link, use mouse mark area of object and it and double click on area beside object.



11.1.6 Line object

Line object allows you to draw and design lines on the topology.

Step 1. Add a Line object to the topology

ADD LINE ✕

Width:

Arrow Style:

Paint Style:

Line Style:

Line Color:

Line Label:

Width: Increase or decrease the width of the line. This can be edited later in the “Shape Edit” menu.

Arrow Style: Allows you to make arrows to your Line object. Single arrow, Double arrows or no Plain. This can be edited later in the “Shape Edit” menu.

Paint Style: Allows you to solid or dashed style for line. This can be edited later in the “Shape Edit” menu.

Line Style: Allows you to choose a style Straight, Bezier, Flowchart or StateMachine for the line. This can be edited later in the “Shape Edit” menu.

Line colour: Allows you to choose a colour for the line. This can be edited later in the “Shape Edit” menu.

Line label: Allows you to add a label on the line. This can be edited later in the “Shape Edit” menu.

Example, Dashed, Bezier, double arrow line with label:

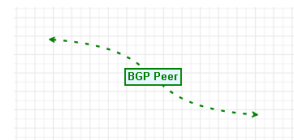

Positioning and moving line object. Line object has invisible connection points at the ends. Use mouse to find that point, drag and drop move line connection point to your preferred lab location. Use mouse to move other line endpoint on lab location.

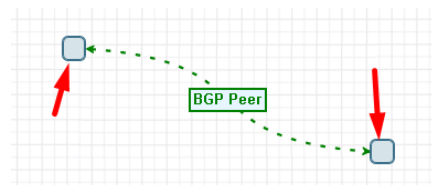

To move all line, use CTRL to mark line endpoint and move line over topology to position it.

Edit Line object. Right click on line to call out edit window:

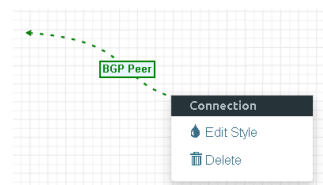



11.1.7 Nodes connection links design

Refer Section [9.1.5](#)

11.1.8 Cloning objects and overlay positions

Right click on the object you want to clone and choose “Duplicate”. You can also change the object’s overlay position using the “Send to Back” or “Send to front” options.

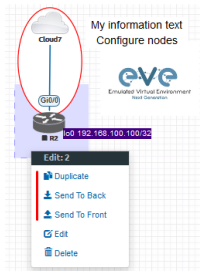

11.1.9 Objects Editing

Right click the object and choose “Edit” for additional options.

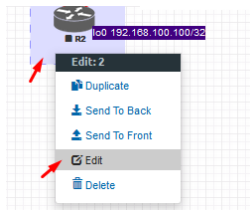

At the bottom of the “Topology Canvas” page, additional object options will appear



Z-index: Used to change the object’s overlay position on the “Topology Canvas.” An object with a higher numerically valued z-index will cover an object with a lower numerically valued z-indexed.

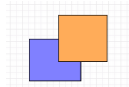

Example: The blue object has a z-index of -1 and the orange object’s z-index is 0. Orange object is top over blue object.

Border width: Used to change the object’s border width.

Border type: Used to change the border style of the object between solid and dashed.

Border colour: Used to change the colour of the object’s border

Background colour: Used to change the background colour of the object

Transparent: Turns off background colour (filling) and makes the object transparent.

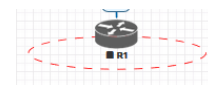

Rotate: Used to rotate the object on the topology.

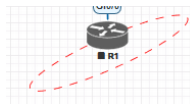

Name: Used to change the object's name.

To save the object, press Save (green button).

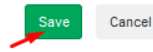

11.1.10 Lock objects movement

The “Lock Lab” feature prevents objects from being moved around on the canvas (among other things). For more information about this feature, refer to section 8.1.14.

11.2 Custom design logical topology

EVE Pro includes a feature to upload your own custom topology picture and map nodes to it for easy access.

11.2.1 Custom design upload

Before you upload a custom picture in the lab, make sure it is in .png or .jpg format with resolution 130-150x130-150 pixels.

TIP: It is best is to create a topology in the MS Visio and after convert it to the .png picture format with resolution 140x140.

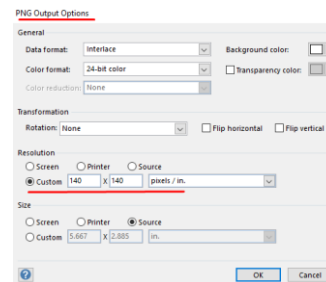

Step 1: Open “Add an Object” and then “Pictures” from the left sidebar or right click on a free area on topology canvas and hit “Add Picture.”

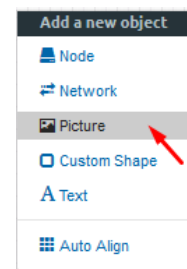

Step 2: Browse your PC for a .png or .jpg file and hit “Add”.

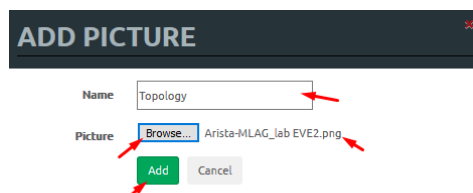

Once the picture is added to the topology canvas, the sidebar will display a new option: “Logical maps”

Step 3: Open the “Logical maps” menu item.

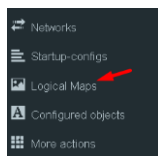

Pictures window management

	Delete uploaded picture from the lab
	Image Map: Map nodes to places in the picture
Topology	Display uploaded picture. Work with lab and custom topology
	Zoom/unzoom uploaded custom topology
	Makes the window transparent to see the “Topology Canvas” behind it. Clicking again returns to the normal view.
	Close “Pictures” window.

11.2.2 Custom topology mapping

This feature allows you to map the lab nodes to your custom topology picture.

Step 1: Open the Image Map window:



Step 2: Select a node, from the dropdown menu, that you want to map to the topology.

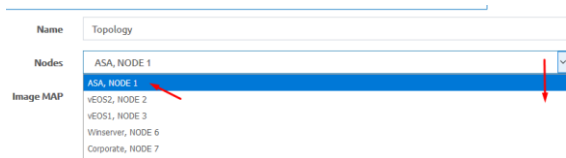

Step 3: Move your mouse over a node icon on the “Image Map” and click to map it. The grey circle means that the node is mapped.

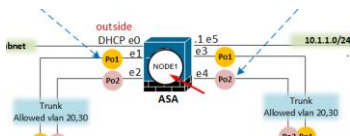

Step 4: Continue mapping the rest of the nodes.

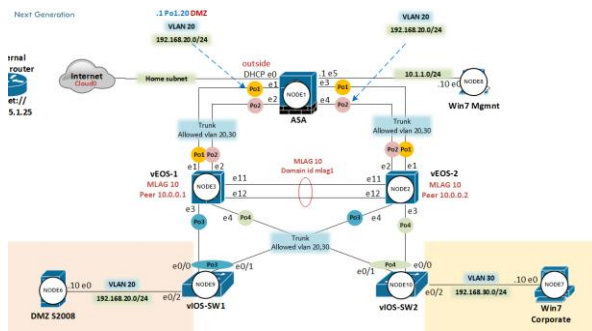

Step 5: OPTIONAL. You can also add a mapping for a device external to your EVE server in order to telnet, VNC, or RDP to it. This way you can open sessions to all your devices (whether external or internal) in one place.

Select from menu:

Nodes

And map with node on topology.



Change image map adding protocol, IP and port.

Image MAP

Image MAP

Step 6: Save your mapping and refresh the browser with F5.

11.2.3 Delete topology or mapping

To delete a single node mapping, right click on node mapping circle and click “Delete.”

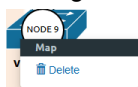

To delete the entire custom topology, click delete.

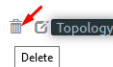

11.3 Multi-configuration sets export feature

Eve Professional/Learning Center includes a "Multi-configuration Set" feature that allows you to save and manage multiple sets of configurations in a single lab. The "Configuration Export" and "Startup-configs" features will allow you to set these saved configurations as startup configs for your nodes when they boot.

⚠ IMPORTANT NOTE: Before you start using the “Multi-configuration Set” feature, you must complete at least one configuration export.



Nodes will be greyed out without the option to enable “Startup-configs” until you complete at least one configuration export for each node.

Node boot order:

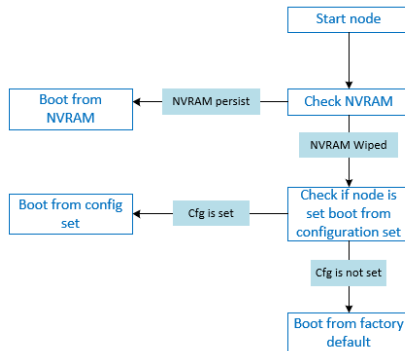

NVRAM: NVRAM is used as writable permanent storage for the startup configuration. During the boot process, the node will always check NVRAM for a saved configuration. Saving the configuration to NVRAM requires a vendor specific command. Cisco: copy run startup (wr), Juniper: commit, etc. It is **MANDATORY** to save a node’s configuration before you can export it.

Exported configuration: A node configuration that has been exported from the node. It can be used to backup configurations or to set them as startup-configs.

Wipe node: Wiping a node will erase the NVRAM (running config) or the temporary image snapshot, depending on the type of node. Upon a successful wipe, the node will boot with the factory default configuration or the configuration included in the base image you are using. If you have the “Startup-config” feature enabled for the node, then it will boot with the chosen config set. You must wipe a node after changing certain node template settings like the image or startup-config. You also must wipe the node the first time you want to enable the “Startup-config” feature.

Factory default configuration: The base configuration that is applied from the manufacturer.

11.3.1 Supported nodes for configuration exports

- Cisco Dynamips all nodes
- Cisco IOL (IOS on Linux)
- Cisco ASA
- Cisco ASA v
- Cisco CSR1000v
- Cisco Nexus 9K
- Cisco Nexus Titanium
- Cisco vIOS L3
- Cisco vIOS L2

Cisco Viptela vEdge, vSmart, vBond, till version 18.4 only, version 19.x and later is not supported due implemented password setup feature on the first boot.

Cisco XRv
Cisco XRv9K
Juniper VRR
Juniper VMX
Juniper vMX-NG
JunipervQFX
JunipervSRX
Juniper vSRX-NG
Mikrotik
PFsense FW
Timos Alcatel
vEOS Arista

11.3.2 Startup config management

11.3.2.1 Global commands

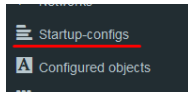

Configurations can be managed via the “Startup-configs window which can be accessed from the sidebar menu while on the Topology page.

Topology page, More Options:

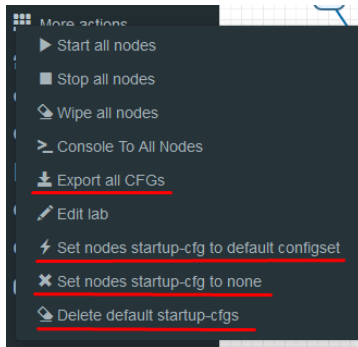

Export all CFGs – Exports all supported node configurations.

Set nodes startup-cfg to default configset- Sets all supported nodes to boot from the default configuration set.

Set nodes startup-cfg to none - Sets all supported nodes to boot from NVRAM configuration.

Delete default configuration set. **Warning**, this will delete your exported default configuration set for all nodes.

11.3.2.2 Individual node commands

Select node, right click

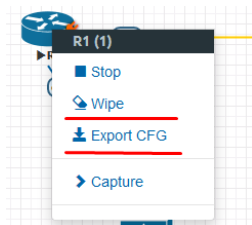

Wipe: Wipes the NVRAM for a single node

Export CFG: Exports the configuration for a single node

11.3.2.3 Multiple selected nodes commands

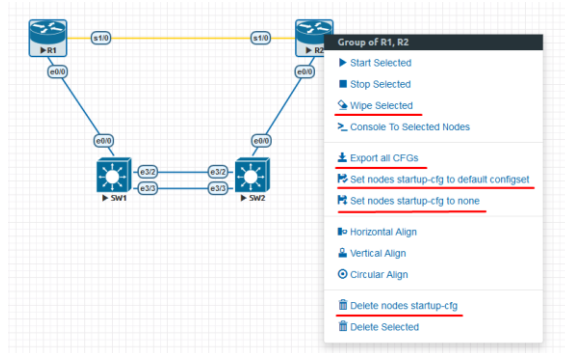

Wipe Selected: Wipes the NVRAM for selected nodes

Export all CFGs: Exports the configuration for selected nodes

Set nodes startup-cfg to default configs set: Set selected nodes to the default config set

Set nodes startup-cfg to none: Set nodes to boot from NVRAM or from factory default if wiped.

Delete nodes startup cfg: Delete selected node's startup cfg. (clean default set)

11.3.2.4 Startup-configuration window

No configuration exports or manual configs loaded for nodes

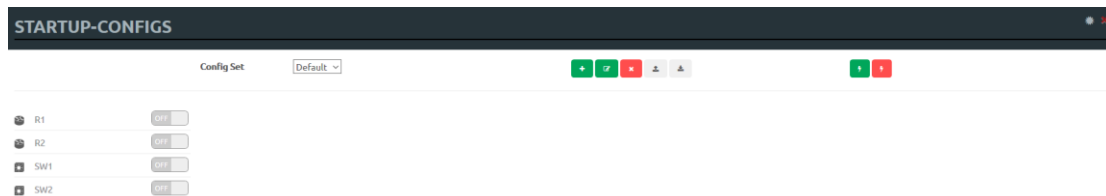



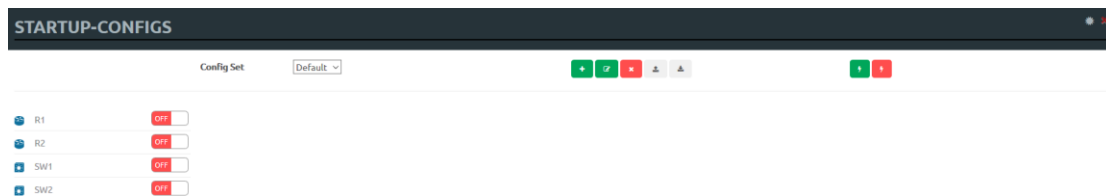



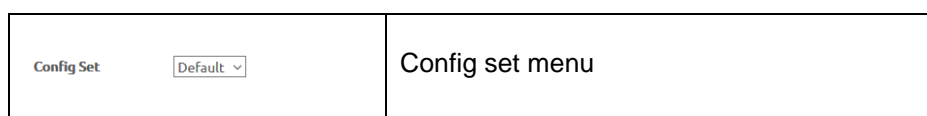



Startup-configs are exported and the "Configuration Export" feature can be used.

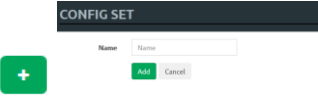
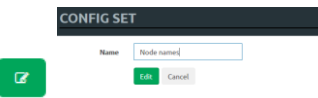

11.3.2.5 Startup-config window information

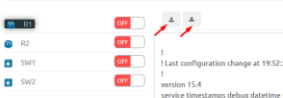

	<p>No configuration is available for node. Grey node</p>
	<p>Configuration is available and can be used. Blue node. Exported configuration persist</p>
	<p>Configuration persist but it is disabled. Node will boot from NVRAM or factory default if it is wiped</p>
	<p>Configuration persists and node will boot from the configuration after being wiped</p>
	<p>Add new config set.</p>
	<p>Rename config set. The Default Config Set cannot be renamed.</p>
	<p>Select a Config Set and delete it. You cannot delete the Default Config Set. The Default configuration set can be cleaned using the sidebar / More options / Delete default configuration set</p>
	<p>Upload configuration set from your local PC</p>
	<p>Download configuration set to your Local PC</p>
	<p>Apply Config Set button: Sets all nodes to boot from the chosen config set.</p>
	<p>Config Reset button: Sets all nodes to boot from none. Node will check boot order. If the Wipe function is used, nodes will boot from factory default.</p>
	<p>Individual node export or import configuration. Configuration export/import file format is .txt.</p>

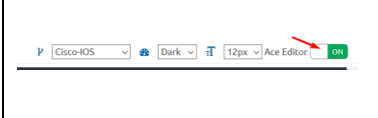
	<p>Ace Editor. Different vendor configuration edit option. Just Text visual format.</p>
---	---

11.3.3 Export Default configuration set

⚠ NOTE: The default configuration set is hardcoded. It is mandatory to export a nodes config before you can start building custom configuration sets.

Example:

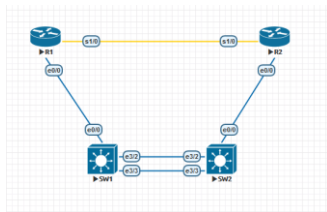

Step 1: **MANDATORY:** Configure your nodes and make sure you applied the vendor specific command to save the running configuration to NVRAM. If you do not save the configuration, it will not be exported and in the notification area, you will receive an error message stating the node cannot be exported.

In this example the nodes have been configured with hostnames only and the configurations have been saved to NVRAM.

Step 2: Chose any method to export configurations to the Default Config Set. You can use export a single node, a group of nodes, or all nodes. Only supported nodes configurations will be exported.

Step 3: In the example below a group of nodes were selected to export configurations.

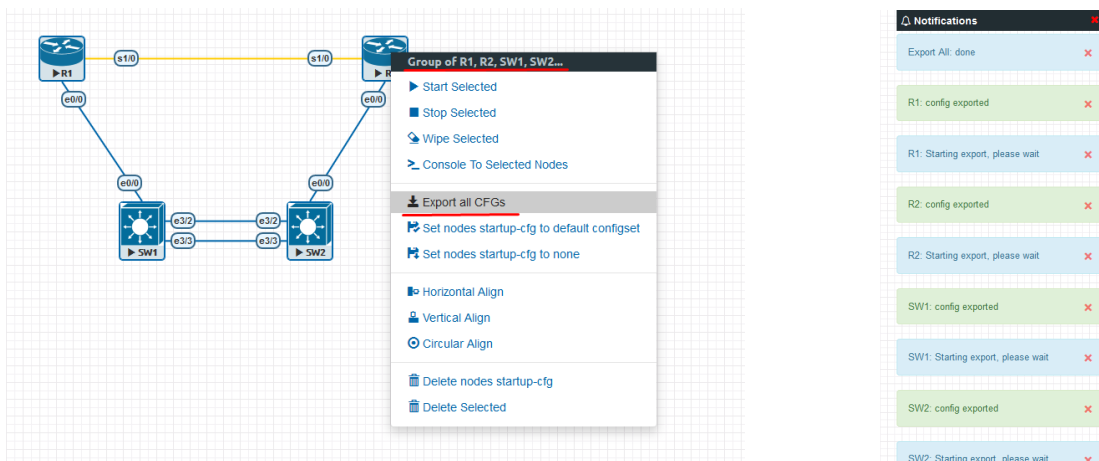

Default configuration set is completed. The notification area will display "Export All: done" when complete.

NOTE: you can configure your nodes with your preferred configuration and make it the default configuration set.

11.3.4 Boot nodes from exported Default config set

Step 1: Stop all nodes

Step 2: Open sidebar and click Startup-configs. Make sure your config is set to default and the nodes config switch is green (switch on/off beside node). Press the green “Apply Config Set” button (Set all nodes to selected config set) and all your nodes will boot with the default config set after wiping them.

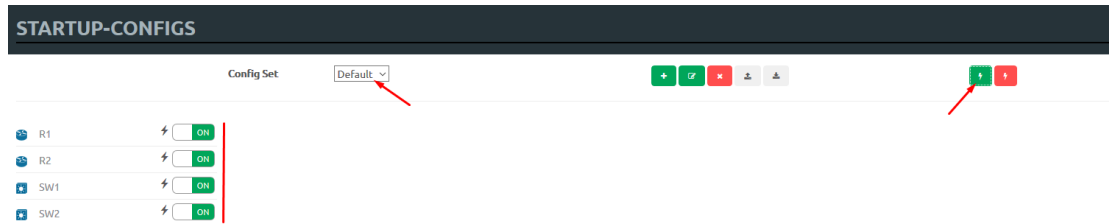

Step 3: Wipe nodes. For more information refer to section 9.1.3

Step 4: Start nodes

11.3.5 Export new custom config set

This section will describe how to create a new custom configuration set for the same example above.

⚠ Make sure your nodes are running and booted from the default set.

Step 1: Create new custom named (e.g. “IP Addressing”) configuration set, Press Add new config set.

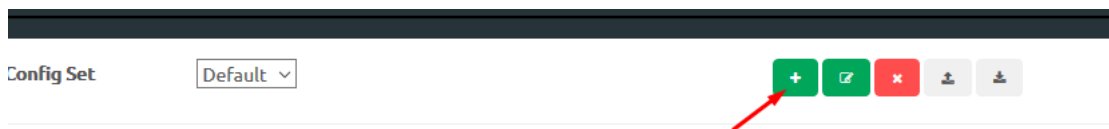

Name it and press Add.

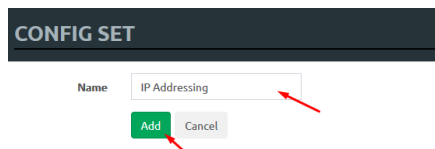

The new configuration set is created.

⚠ NOTE: It will duplicate the default configuration set under your IP Addressing config set.

Step 2: Select newly created Config set IP Addressing and hit the green confirm button (Set all nodes to selected config set) on the right.



Step 3: Make sure your nodes have the Startup-config slider switched to “ON” and verify the config set menu has the “IP Addressing” set selected.

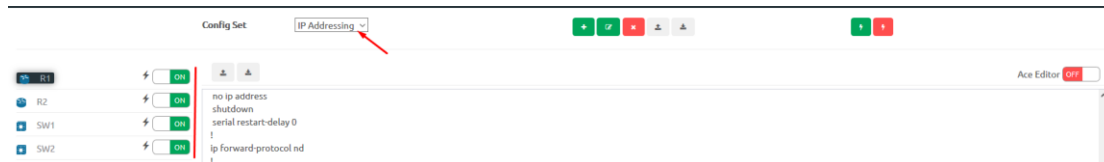

Step 4: Return back to your lab and continue configuring nodes until your preferred configuration is complete. In this Example, the IP addresses are configured on the nodes.

Step 5: **IMPORTANT**: YOU MUST save the configuration on all nodes, even if the configuration was not changed.

Step 6: Use any method (individual, group or all) to export the new configurations to the IP Addressing set.

Step 7: You can verify that the configs were exported by re-opening the “Startup-config” window.

Make sure the correct config set is selected, and check if the configuration is exported for the node or nodes.

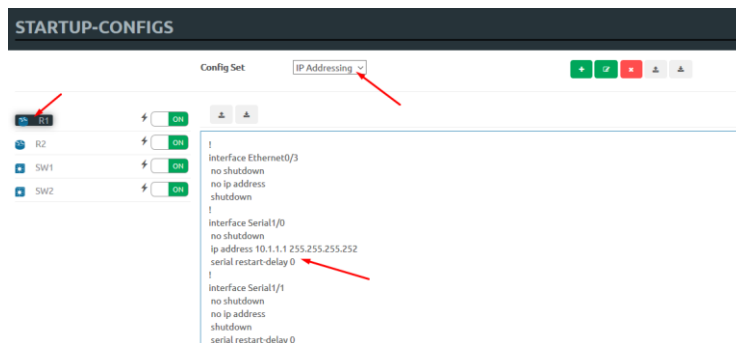

Repeat steps 1-7 of this section for the next configuration set.

11.3.6 Edit exported configurations

It is possible to edit your configurations for the nodes manually.

Step 1: Select a config set and apply it with the green confirm button (Set all nodes to selected config set) on the right.

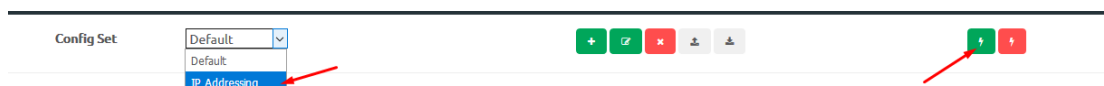

Step 2: Select the node you want to edit the configuration of and make your changes. Click “Save” when you are finished.

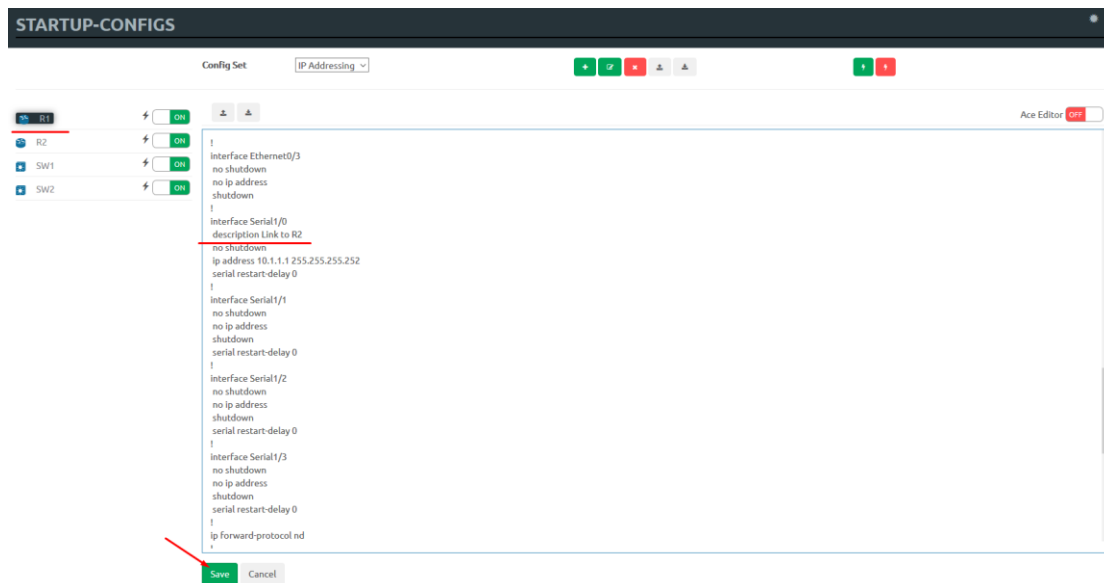

Step 3: Apply the config set to all nodes with the green “Apply Config Set” button on the right (Set all nodes to selected config set).



- ⚠ NOTE: you can manually copy/paste any configuration into the config set editor and apply it to your node. Make sure your configuration interfaces match the lab node’s interface names.

11.3.7 Set lab to boot from config set

To set your lab nodes to boot from the exported configuration, follow the steps below:

Step 1: Wipe nodes. Refer to section 11.3 for information about wiping nodes and the order of operations during boot.

Step 2: Open the “Startup-configs” window from the left sidebar.

Step 3: Select your preferred config set and apply it by pressing the green “Apply Config Set” button on the right (Set all nodes to selected config set).



Step 4: Start nodes.

11.3.8 Set lab to boot from none

To reset your lab nodes’ configuration to factory default follow the steps below:

Step 1: Wipe nodes. Refer to section 11.3 for information about wiping nodes and the order of operations during boot.

Step 2: Open the “Startup-config” window from the left sidebar

Step 3: Press the red “Config Reset” button on the right (Set all nodes to no startup-config).



Step 4: Start nodes

11.3.9 Delete a config set

Select the config set you want to delete and click the “Delete” button. You cannot delete the default config set.



11.3.10 Rename a config set

Step 1: Select the config set you want to rename. Change the name and hit “Save.” You cannot rename the default config set.

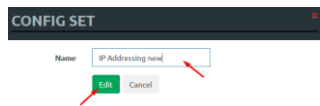

11.3.11 Export a config set to your local PC

It is possible to export configuration sets to your local PC.

Step 1: Select the config set you wish to export.

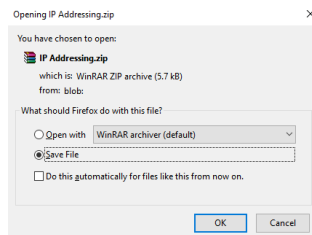

Step 2: Save it on your local PC.

NOTE: You can open this archive and edit your node configs manually. Archived configs are saved in txt format. After editing you can archive it back to .zip format and import it in EVE.

11.3.12 Import config set from local PC.

It is possible to import config sets to your lab.



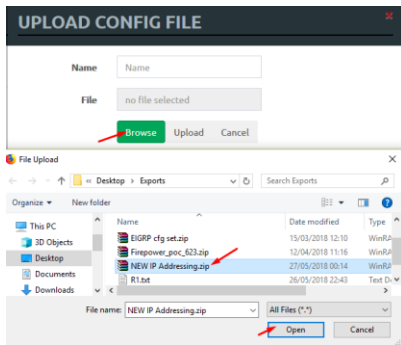

Browse to the file on your PC, select the archive or config set and upload it.

Uploaded config sets without a Name will appear in the config set menu with the name "Import". To rename config sets, refer to section 11.3.10

11.3.13 Export a single nodes config to your local PC

Open the "Startup-configs" window from the Side bar. Select the node that you want to export the configuration of and click the "Export" button.

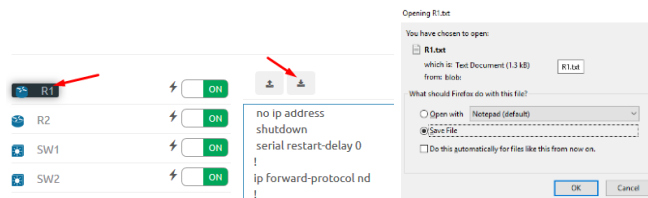

11.3.14 Import a single nodes config from your local PC

Open the "Startup-configs" window from the sidebar. Select the node that you want to import the configuration to and click the "Import" button. Browse to the file on your local PC and click "Upload."

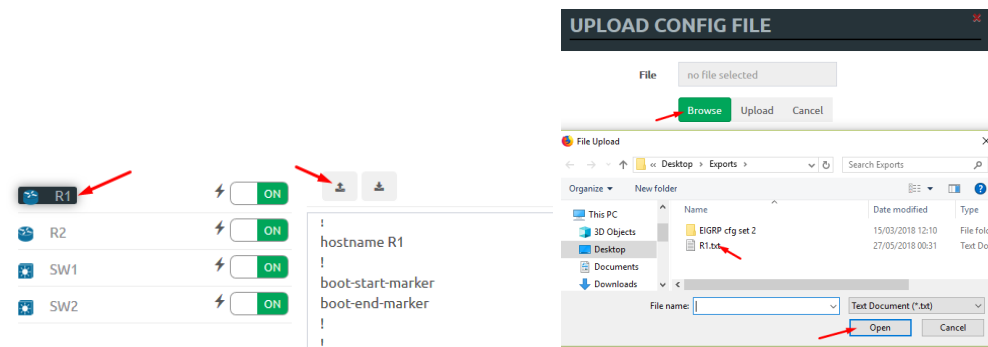

NOTE: The configuration must be in txt file format.

11.3.15 Set lab nodes to boot from different config sets

The "Multi Configuration set" feature allows you to set nodes to boot from different config sets in the same lab.

Option 1: Open the "Nodes" list from the left sidebar. Choose your node and select a config set from the dropdown. Stop the node, wipe it and start it again. Your node will boot from the selected config set.

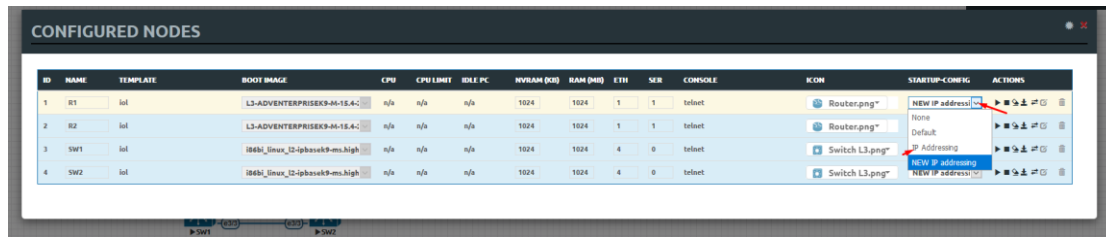

Option 2: Stop the node, right-click on the node and click “Edit.” Select your preferred config set for the node and click “Save.”

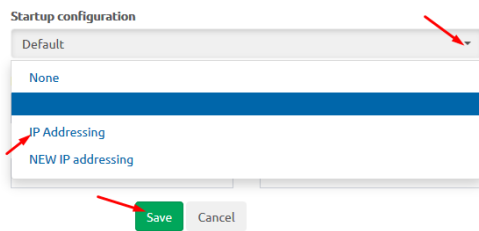

11.3.16 Lab config script timeout

Lab config script timeout is used when nodes are waiting to boot from a config set. The node will literally wait during boot until the configuration is applied from the config set.

Hit “More actions” and then “Edit lab” from the sidebar. Set the config script timeout in seconds. By default, this timer is set to 300 seconds for new labs.

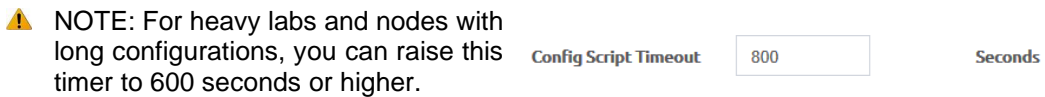

11.4 Lab Timer

For self-controlled lab timing, EVE Pro has integrated a “Lab Timer” feature.

11.4.1 Set the Lab Countdown Timer

Step 1: Click “More Options” and then “Edit Lab” from the sidebar.

Step 2: Set the “Lab Countdown Timer” in seconds for the time you wish to display on the topology and confirm by clicking “Save”. 7200 seconds = 120 minutes.

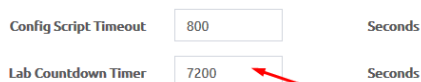

Step 3: To start your lab, be sure all nodes are running.

Step 4: Hit “Lock Lab” from the sidebar. A red sign means that the lab is locked.

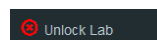

Step 5: When ready to start, click “Refresh Topology” from the sidebar. The countdown timer will be displayed on the “Topology Page” in the top left corner.

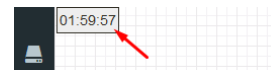

11.4.2 Stop the Lab Countdown Timer

Step 1: Click “Unlock Lab” Grey means that the lab is unlocked.

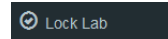

Step 2: Hit “Refresh Topology” from the sidebar

⚠ NOTE: The lab timer does not stop nodes or disconnect sessions from the lab.

11.5 Lab Tasks

Lab task or workbook creation feature.

11.5.1 Creating a new simple task

Step 1: On the side bar click on “Lab Task(s)” to open the Lab Task(s) management window.

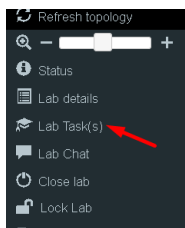

Step 2: Click on the “+” sign to create a new task. Enter the name of the task name and click on “Add” to create the task.



 A form titled "LAB TASK" with a close button (X) in the top right. It contains a text input field labeled "Name" with the value "1. Switching". Below the field are two buttons: "Add" (green) and "Cancel" (grey).

11.5.2 Edit a simple task

Step 1: Press the edit button next to the name of the newly created task.

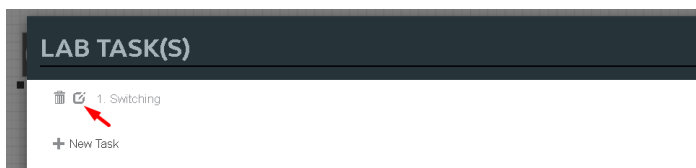

Step 2: Use the rich text editor Window to create your Task / Workbook. It is a recommended option to copy/paste task content from MS Word. Save your Task content by clicking on the “Save” button.

Task 1.1 Basic configuration

Objectives

- Configure switches' hostnames accordingly diagram.

- Configure VTP mode accordingly table below:

Device	VTP mode	Version	VTP domain	VTP password
SW-CM2	transparent	2	evelab	eve
DL5	server	2	evelab	eve
S-AL51	client	2	evelab	eve
S-AL52	client	2	evelab	eve

body div table tbody tr th p span span span span

Save Cancel

11.5.3 Create a multi tabs task (task on multiple tabs/pages)

Step 1: Click on the “+” sign to create a new task. Enter the name of the task name and click on “Add” to create the task.

LAB TASK(S)

+ New Task

LAB TASK

Name: 1. Switching

Add Cancel

11.5.4 Edit a multi tabs task (task on multiple tabs/pages)

Step 1: Press the edit button next to the name of the newly created task.

LAB TASK(S)

1. Switching

+ New Task

Step 2: Click on the “Insert tabs” button.

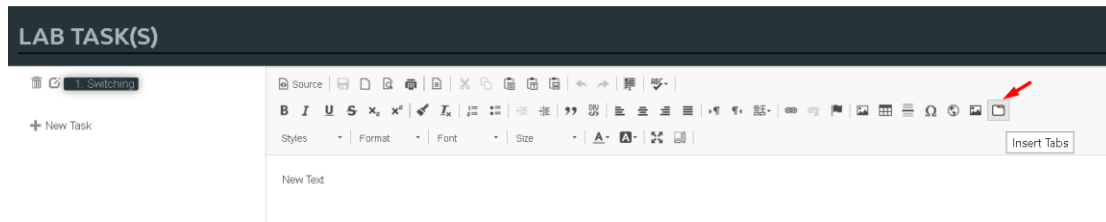

Step 3: Enter the name of your new task group and choose the number of tabs (must be between 2 and 9). Tab names can be changed later.

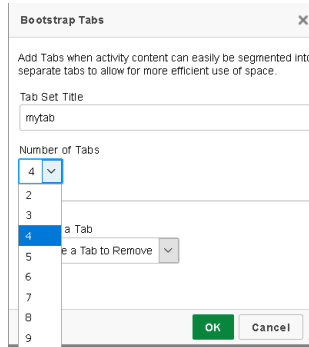

Step 4: To save your your tabbed task, press “Save”.

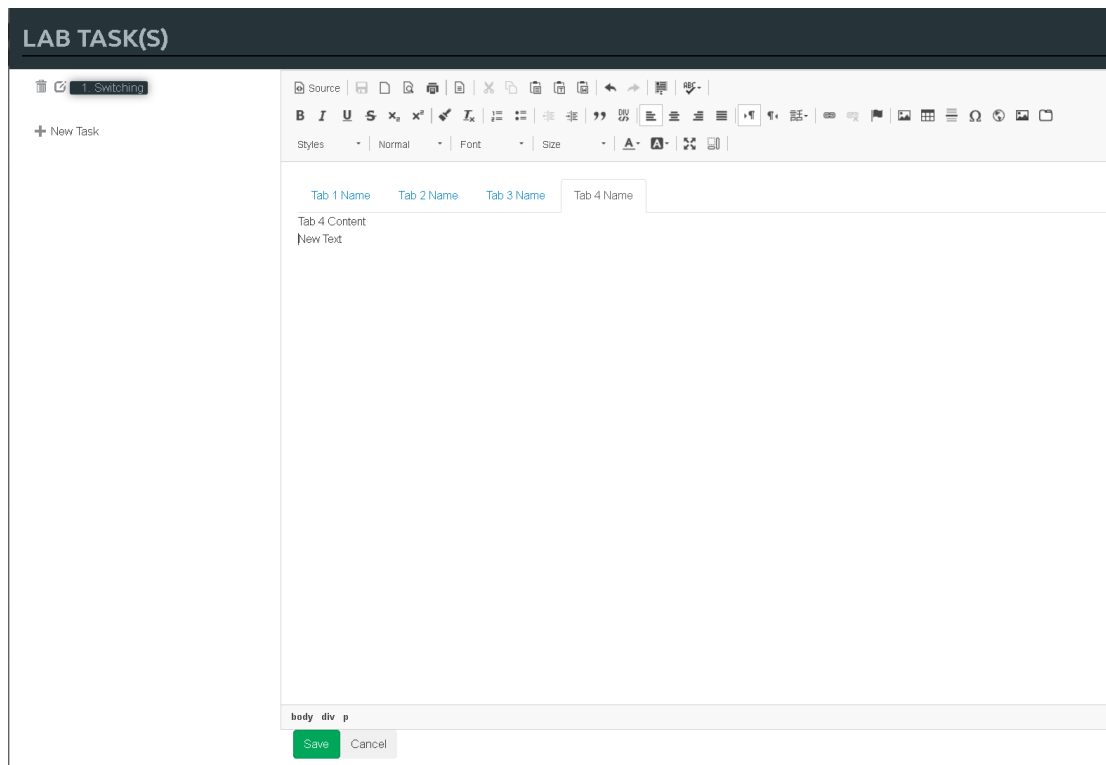

11.5.5 Edit tabs (Multi tabbed task).

Step 1: Activate the tab for which you want to edit its content and press the edit button.

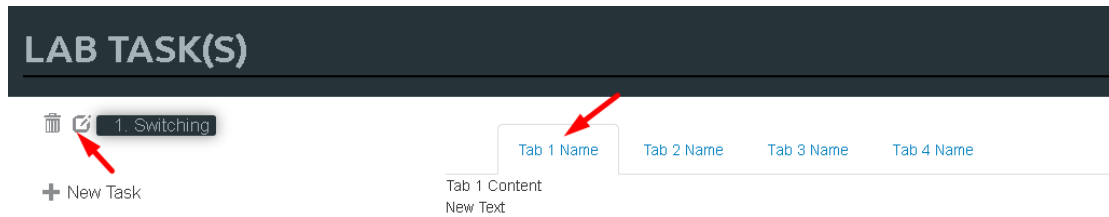

Step 2: Rename your tab,

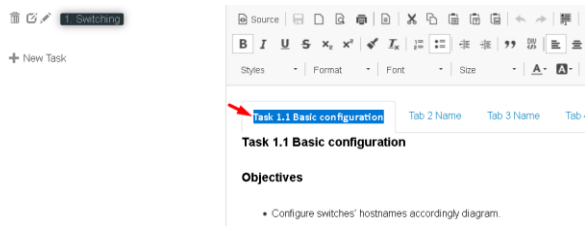

Step 3: Press the “Show Blocks” button, this will help find the right place to create the task tab content. Make sure that you are copying or creating the tabbed task content into the correct place (Tab 1 Content)

NOTE: It is strongly recommended to use “full screen” for the rich html text editor when you are working with tabbed tasks. Press the “full screen” button to work with tasks. Press it again to exit full screen mode.

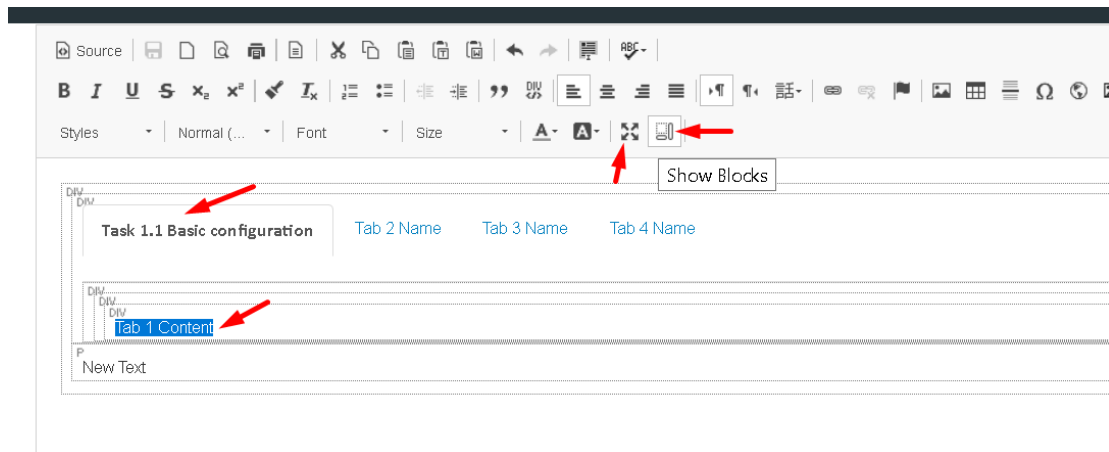

Step 4: Save your modified task by clicking on “Save”. To edit another tab, repeat steps 1-3.

11.5.6 Create a task with your PDF workbook

Step 1: create new Task and name it and press Add:

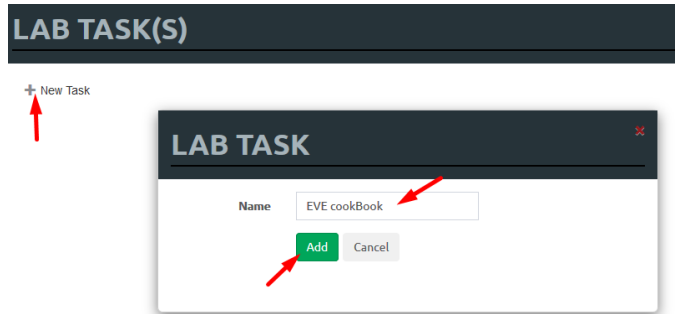

Step 2: Press edit Task and locate PDF button, Press it

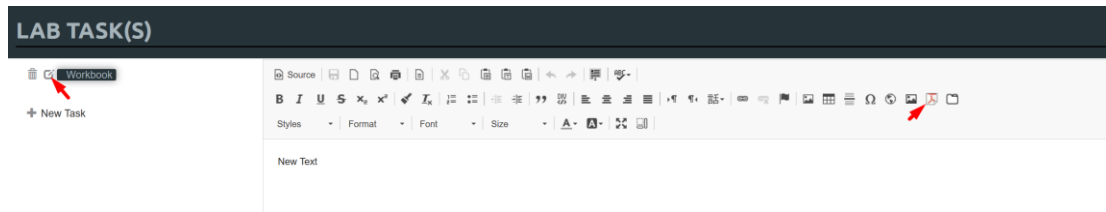

Step 3: Navigate to your pdf document, Press OK.

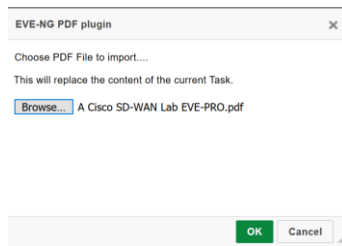

Step 4: To view your uploaded book, use, Side Bar/Tab Tasks/your taskname



11.5.7 Create a task with Online document (PDF or HTML)

Online document or web site task (https ONLY, iFrame allowing use Secure http only)

Step 1: Have ready your link to online web site or document. Example:

<https://www.eve-ng.net/images/EVE-COOK-BOOK-latest.pdf>

Step 2: create new Task and name it and press Add:

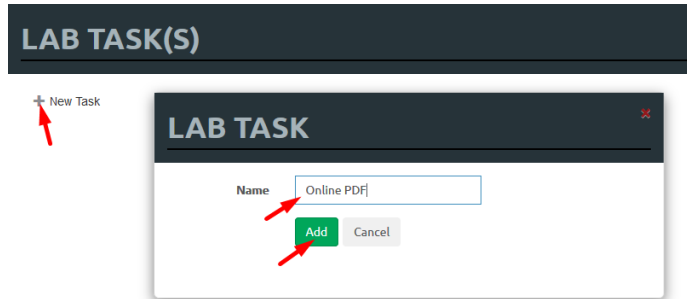

Step 3: Press edit Task and locate iFrame button, Press it

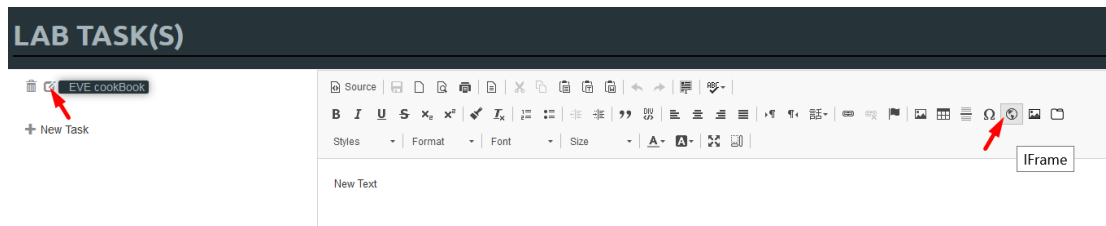

Step 4: Type the path to your online document, set Width to 100%, and Height resolution to 10000.

The path location is <https://www.eve-ng.net/images/EVE-COOK-BOOK-latest.pdf>, which prepared in Step 1. Press OK for iFrame properties and Save Task, Press Save

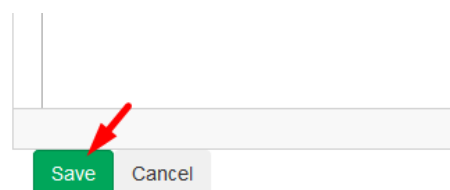
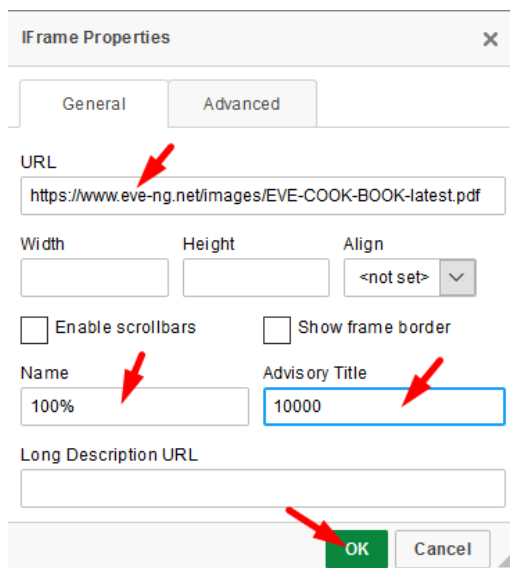

Step 5: To view your uploaded book, use, Side Bar/Tab Tasks/your taskname

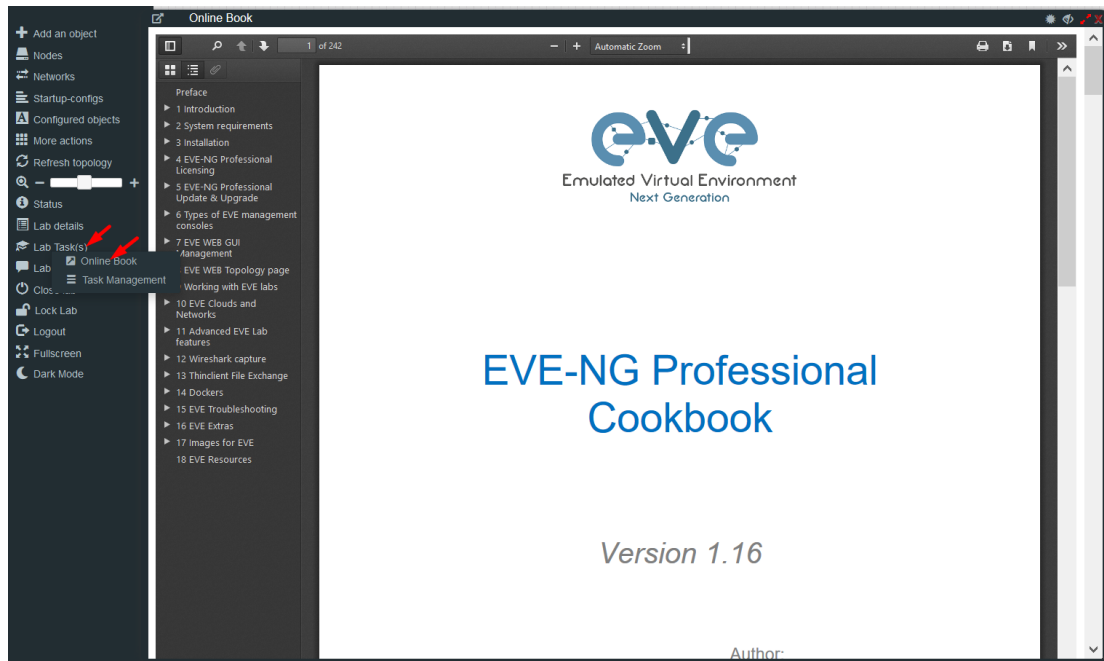

11.5.8 Delete a task

Step 1: From the Side bar click on “Task Management”:

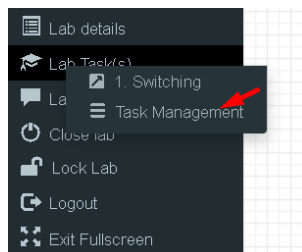

Step 2. Click on the delete symbol next to the task name which you want to delete.

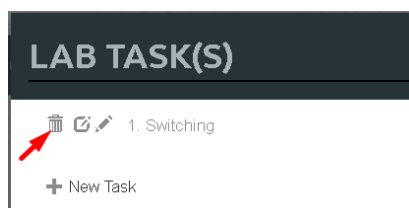

12 Wireshark capture

All EVE-NG Professional and Learning Centre console types have the integrated Wireshark capture feature. This means that it is not necessary to have Wireshark installed on the client machine you are using to access EVE with.

EVE-NG Professional currently supports ethernet interface capturing only.

12.1 Native Console Wireshark capturing

Step 1: Right click on the node you wish to capture, choose "Capture" and then the relevant interface. The capture will open in an HTML session. EVE-PRO supports capture for ethernet and serial interfaces.

Select the interface frame type which will be captured:

- Ethernet for Ethernet, Fast Ethernet, Gigabit Ethernet.
- Serial interface frames: HDLC, PPP or Frame Relay.

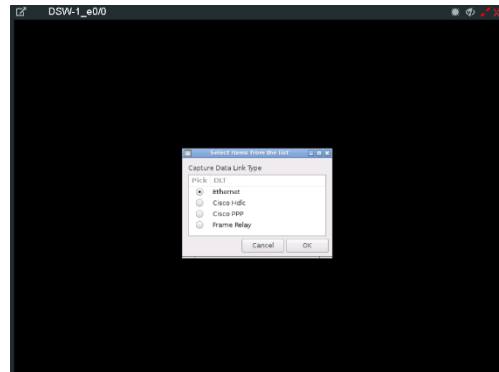

Step 2: To save the captured file to your client PC, stop the capture and choose File/Save As

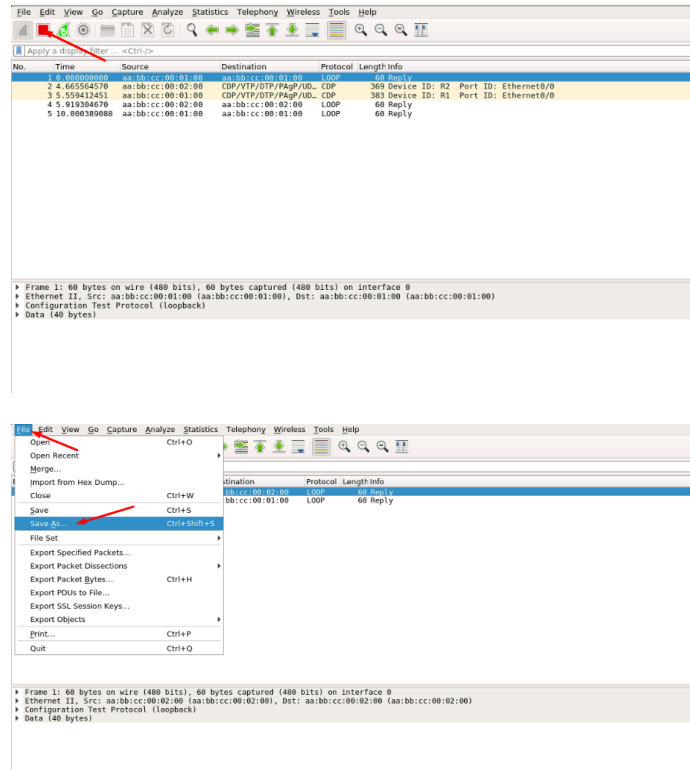

Step 3: Choose the location where you want to save the captured file

IMPORTANT:

`/nobody/thinclient_drives/GUACFS/Download`

Enter a name for your captured file and press Save. Your browser will offer to download your capture file and save on your local PC. Refer Section [12.2](#)

12.2 HTML5 Console Wireshark capturing

Step 1: Right click on the node you wish to capture, choose "Capture" and then the relevant interface. The capture will open in an HTML session. EVE-PRO supports capture for ethernet and serial interfaces. Select the interface frame type which will be captured:

- Ethernet for Ethernet, Fast Ethernet, Gigabit Ethernet.
- Serial interface frames: HDLC, PPP or Frame Relay.

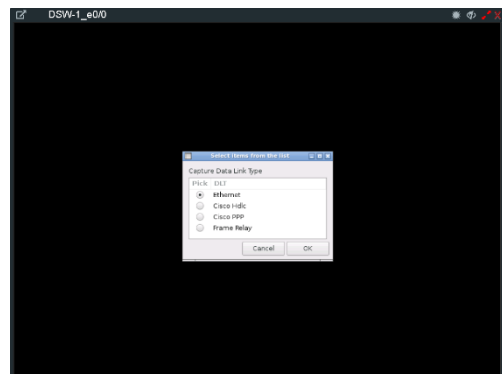

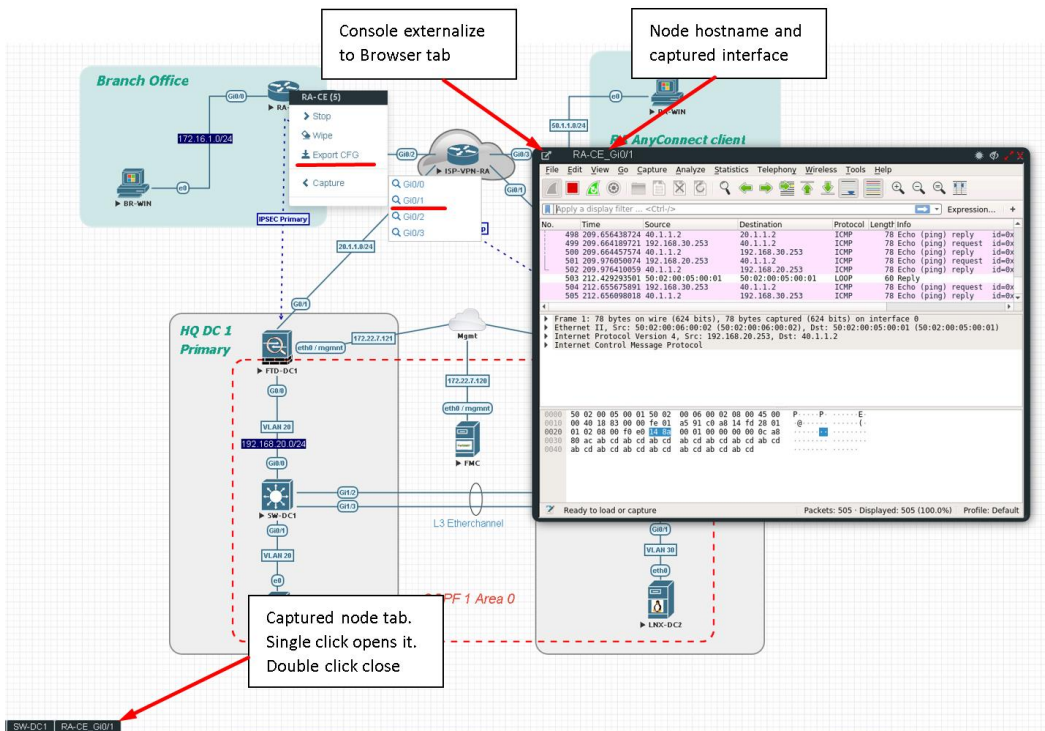

Step 2: To save the captured file to your PC, stop the capture and choose File/Save As

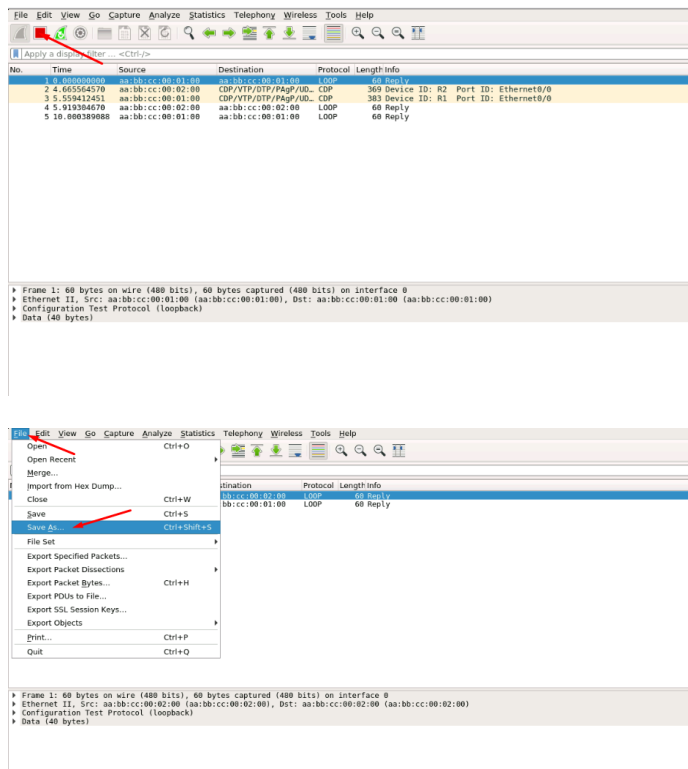

Step 3: Choose the location where you want to save the captured file

IMPORTANT:

/nobody/thinclient_drives/GUACFS/Download

Enter a name for you captured file and press Save.

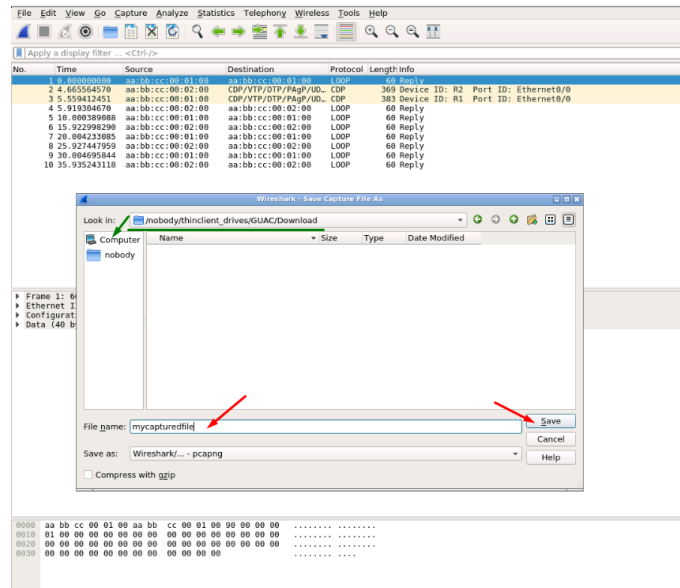

Step 4: A window will open that will allow you to save your captured file on your client PC. If the client PC's browser is set to download automatically, your captured file will be saved in the default browser download folder.

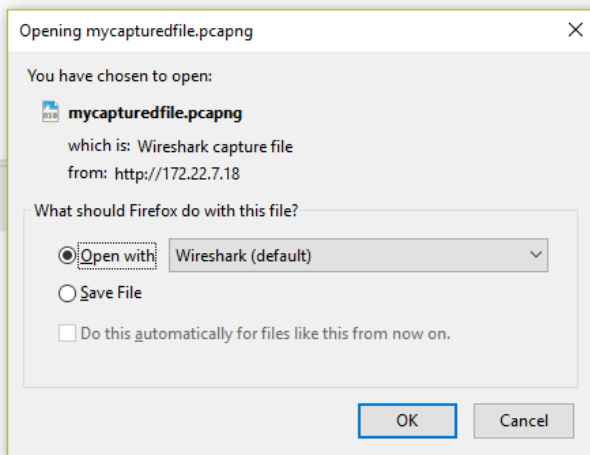

12.3 HTML5 Desktop Console Wireshark capturing

Step 1: Right click on the node you wish to capture, choose “Capture” and then the relevant interface. The capture will open in an RDP session. EVE-PRO supports capture for ethernet and serial interfaces.

Select the interface frame type which will be captured:

- Ethernet for Ethernet, Fast Ethernet, Gigabit Ethernet.
- Serial interface frames: HDLC, PPP or Frame Relay.

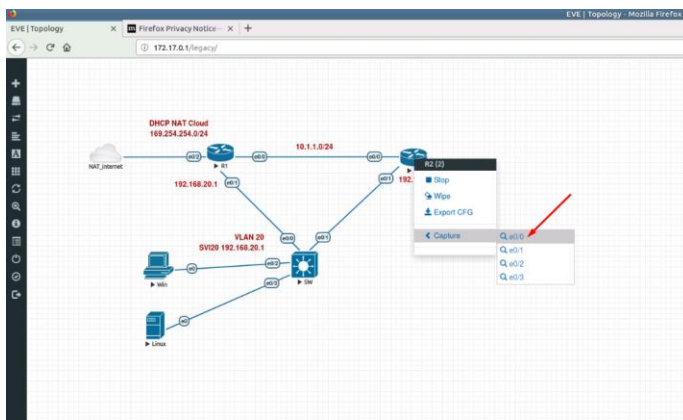
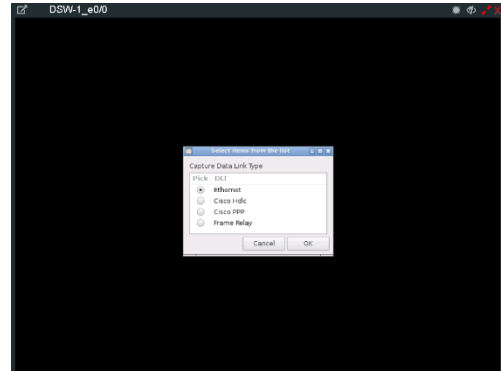

Step 2: Stop capturing with the STOP button.

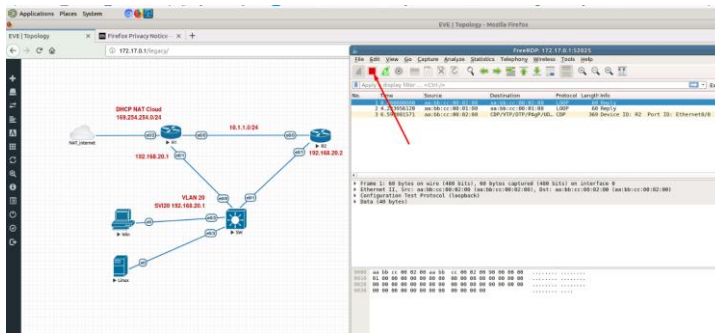

Step 3: Chose File/Save As

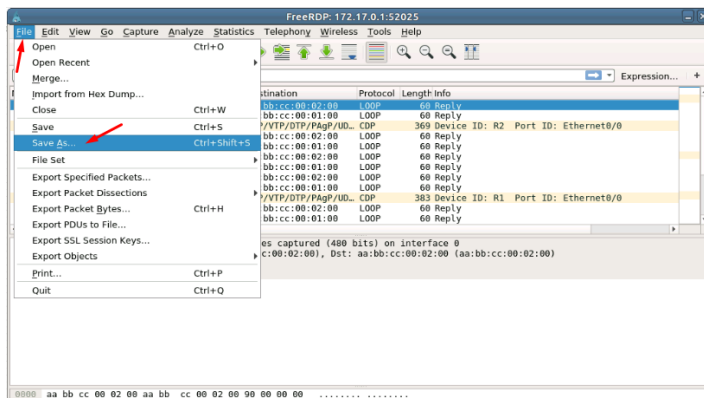

Step 4: Chose the path to save the captured file,

IMPORTANT:

/nobody/thinclient_drives/media/nobody/thinclient_drives/GUACFS/Download/

Enter a name for captured file. Press Save.

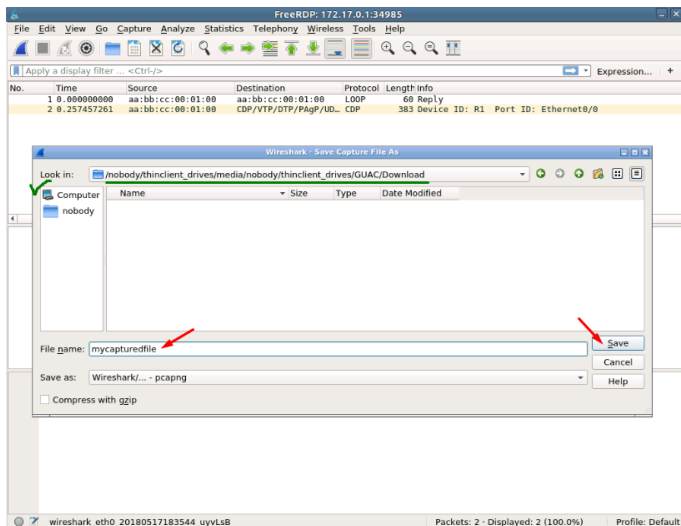

Step 4: A window will open that will allow you to save your captured file on your client PC. If the client PC's browser is set to download automatically, your captured file will be saved in the default browser download folder.

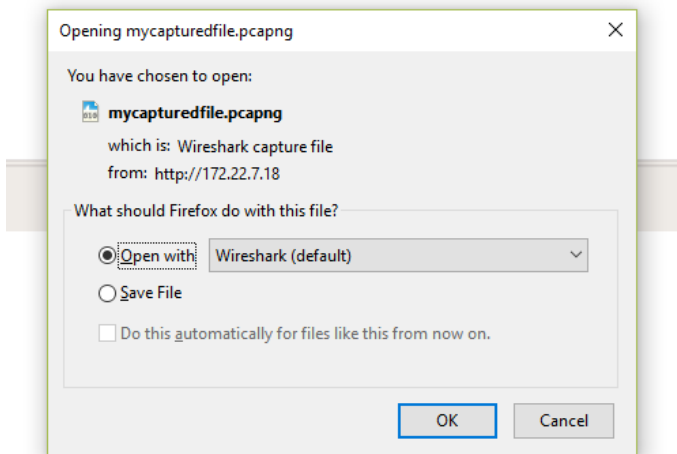

13 Thinclient File Exchange

! NOTE: Thinclient file exchange feature is available for HTML5 or desktop HTML5 consoles only. Make sure you are logged in EVE with one of it.

The Thinclient file exchange feature allows you to transfer files between your native client workstation and the integrated Docker Desktop. It is used when managing EVE via HTML5 consoles. This feature eliminates the need for file transfer software on your client workstation and makes it very easy to import/export labs or download Wireshark captures.

13.1 Thinclient files downloading

The Thinclient file exchange feature allows you to download files from your EVE Server over an HTTP/HTTPS session to your client PC. Examples below will show you how to download exported lab files. This feature is not restricted to just lab files or Wireshark captures. It can be used to download or upload any miscellaneous files you may need.

Example: HTML5 console to server-gui Docker node: We want to export our test.txt file and download it to our client PC over HTML5.

Step 1: Create and save test.txt file on your HTML5 server-gui station.

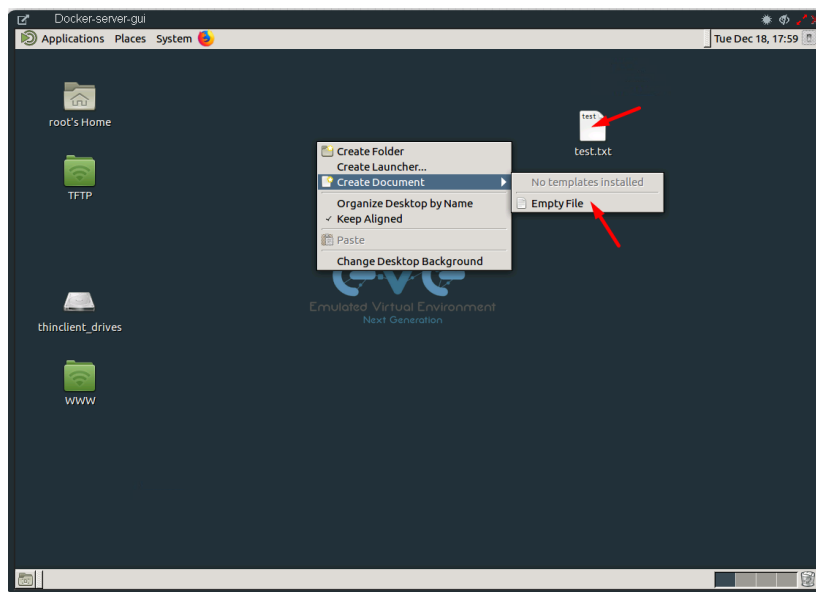

Step 2: Navigate to the desktop of the HTML5 server-gui station and double click **thinclient_drives** and navigate to: **thinclient_drives/GUACFS/Download/**

Step 3: Drag and drop the test.txt file from right to left.

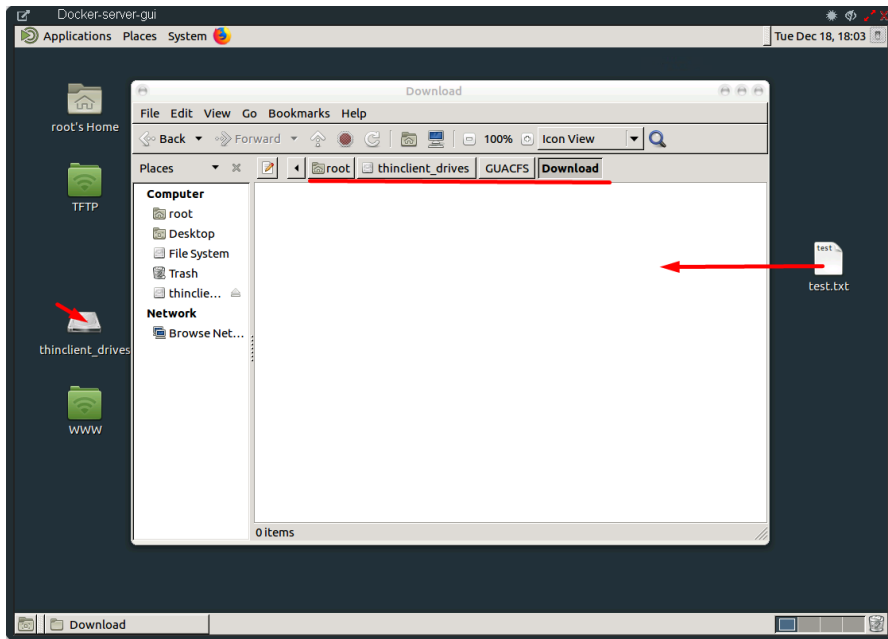

Step 4: A window will open that will allow you to save your captured file on your client PC. If the Native PC's browser is set to download automatically, your selected file will be saved in the browsers default download folder.

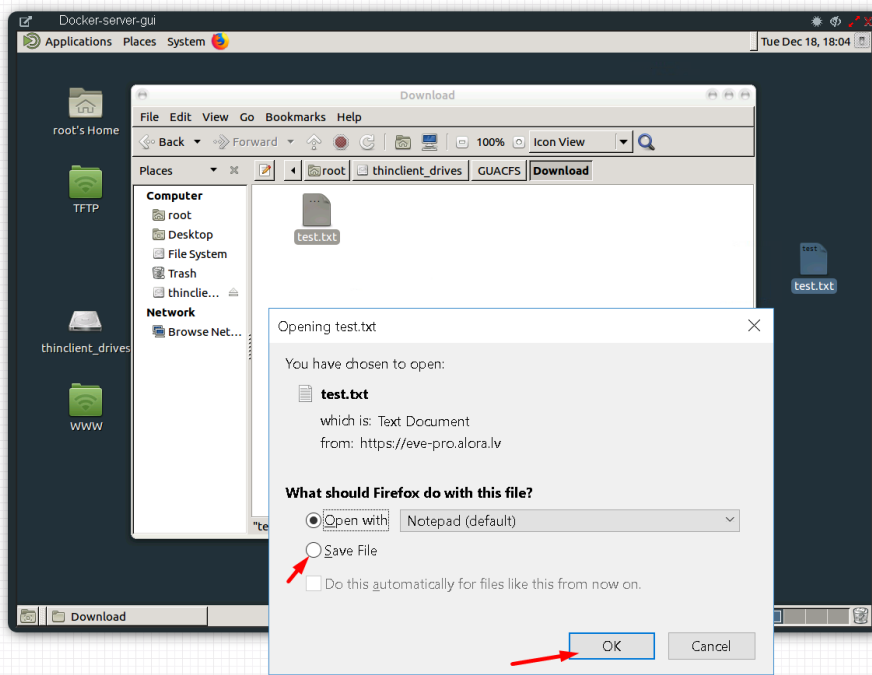

NOTE: Please refer to section 12 for downloading Wireshark capture files from EVE HTML5 consoles.

13.2 Thinclient File upload

Sometimes it is necessary to upload files to your EVE labs. The Thinclient file exchange feature allows you to upload files from your client PC to the EVE HTML5 server-gui station. The

example below will show you how to upload a text file to the EVE HTML5 server-gui station. Any other files can be uploaded the same way.

Step 1: Adjust your browser so that you can see it and the file that you want to transfer.

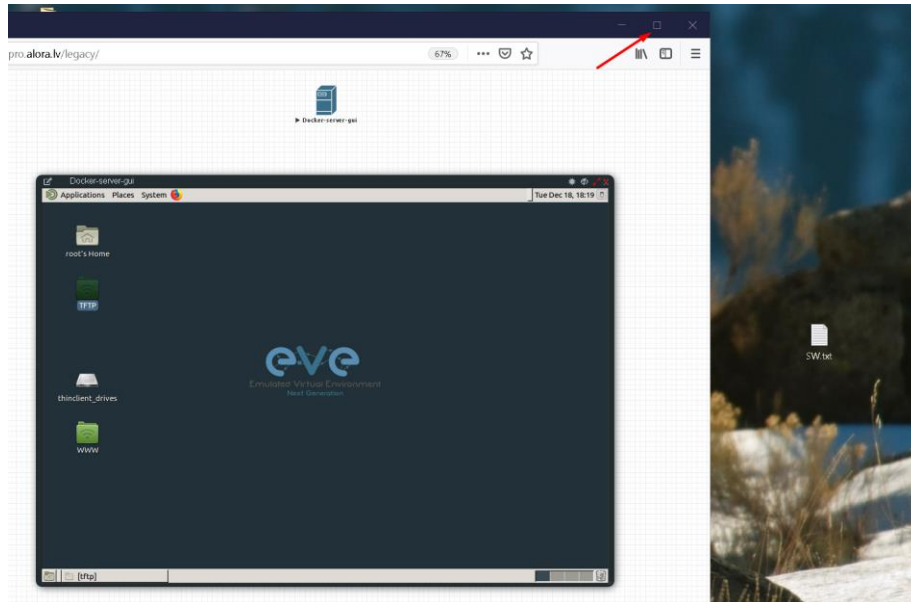

Step 2: On the EVE HTML5 Desktop navigate to: **thinclient_drives/GUACFS/** and drag and drop the file from your client PC to opened location on HTML5 Desktop.

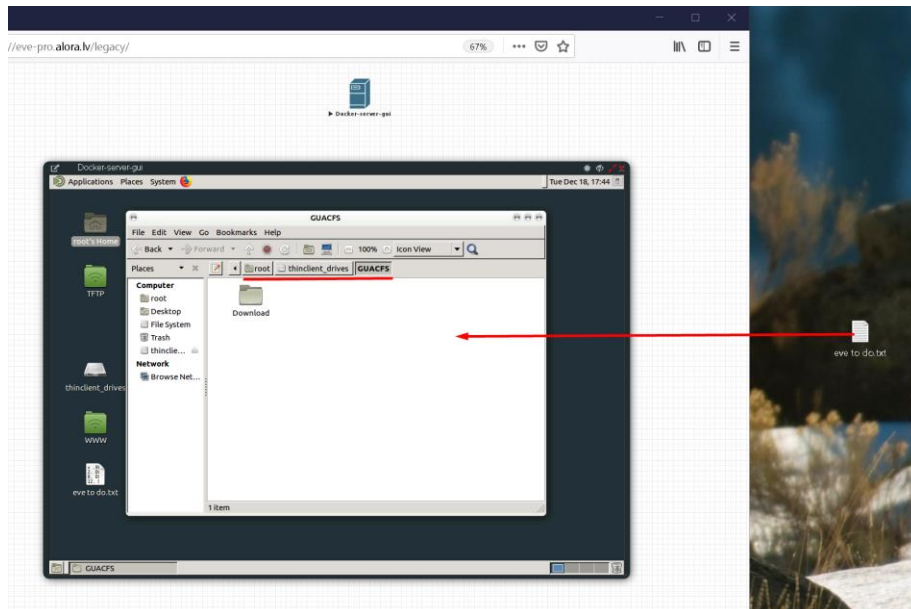

Step 3: Next you will see a notification in the bottom right corner.

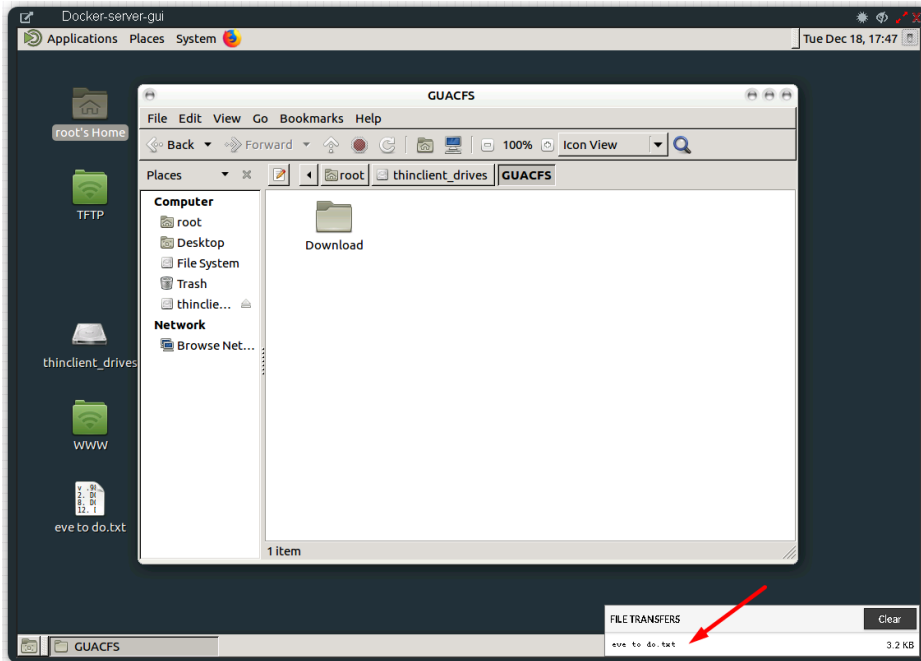

Step 4: To finish the operation and see the uploaded file in the HTML desktop station, press the refresh button. Our Text file SW.txt has been uploaded.

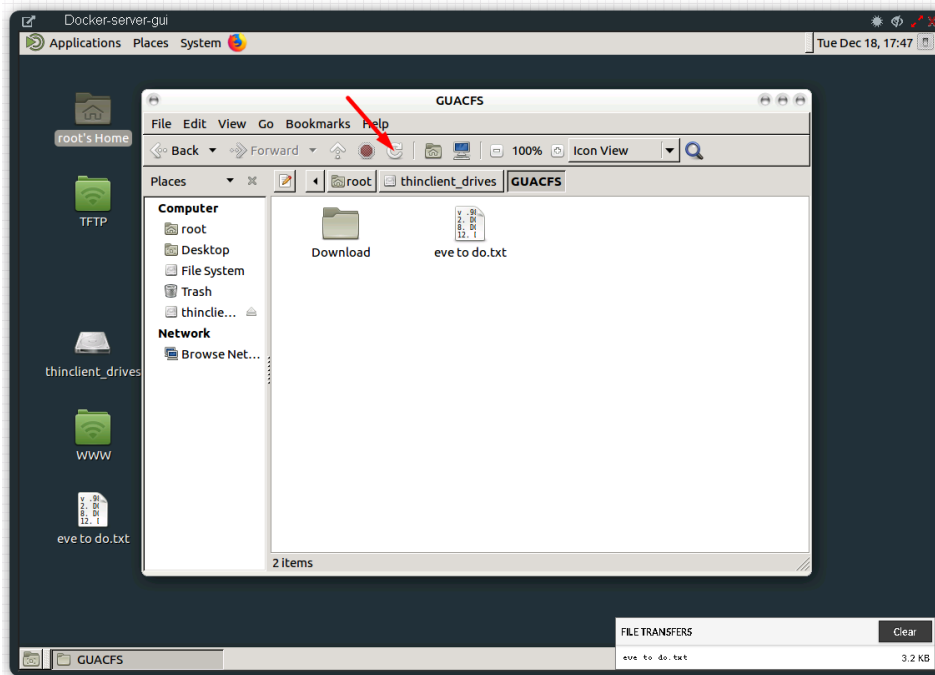

13.3 Other Thinclient file operations

Files that have been uploaded via the thinclient feature can also be transferred to nodes inside your EVE labs via TFTP. In the example below we have uploaded a config file (sw.txt) and would like to transfer it to node R1.

Step 1: Add the **eve-gui-server** docker node to your lab and edit its settings. Set the console type to RDP and configure the IP address settings (DHCP or static) accordingly so that the

docker node can reach the destination node (R1 in this example). For Docker IP addressing please refer to section [14](#)

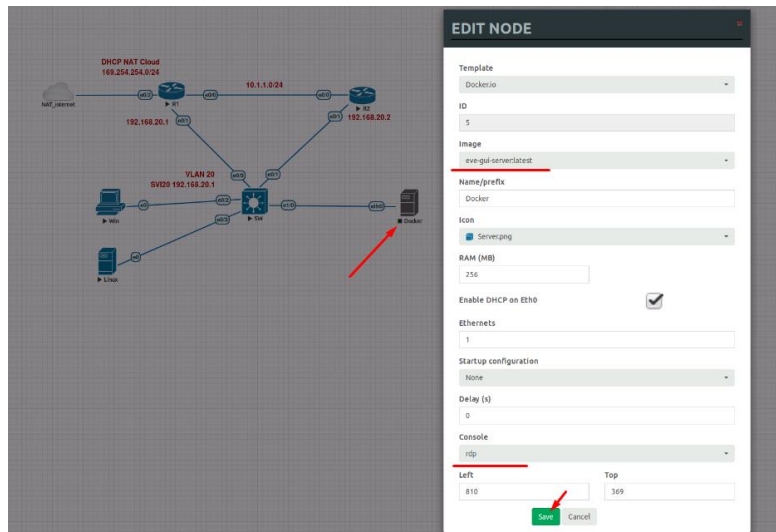

Step 2: Click on the **eve-gui-server** docker node to open an RDP session.

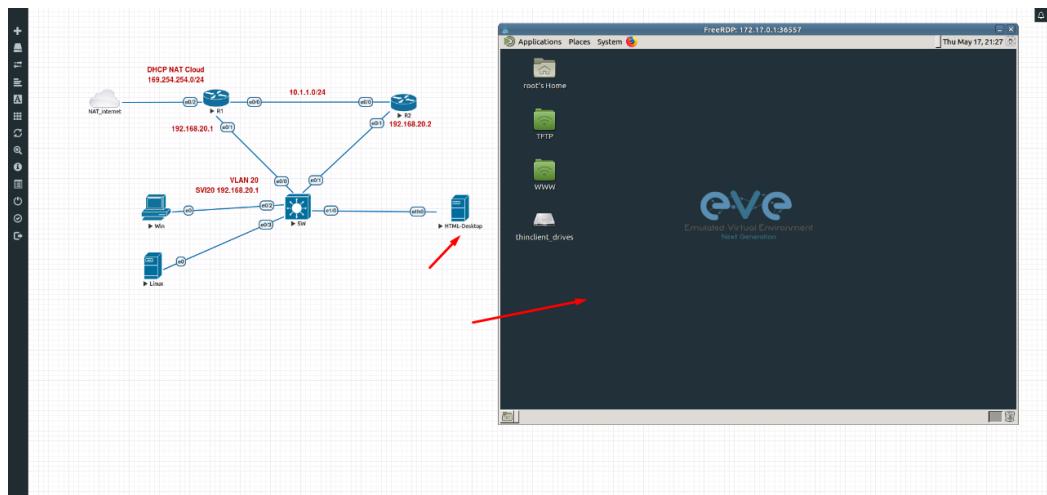

Step 3: Open the **thinclient_drives** location where you uploaded your file to:

[/thinclient_drives/media/nobody/thinclient_drives/GUACFS/](#)

Next, drag and drop your file to the desktop folder named TFTP.

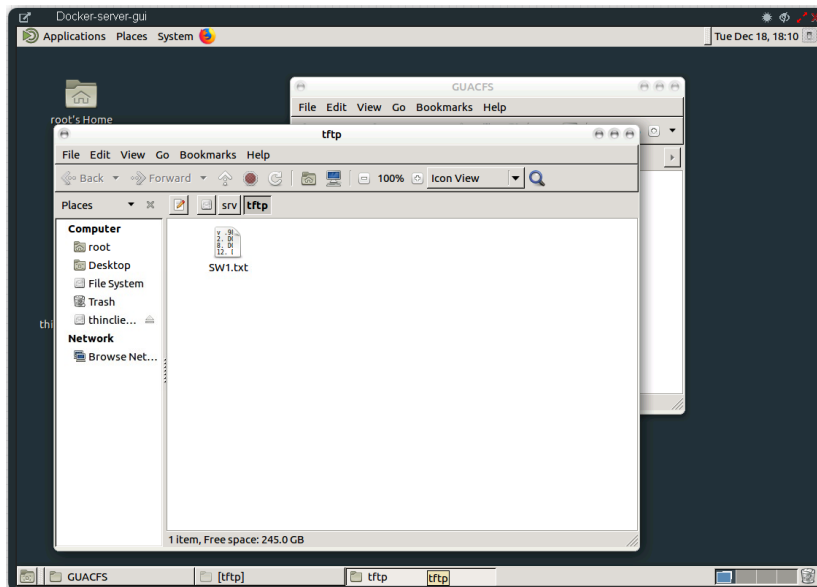
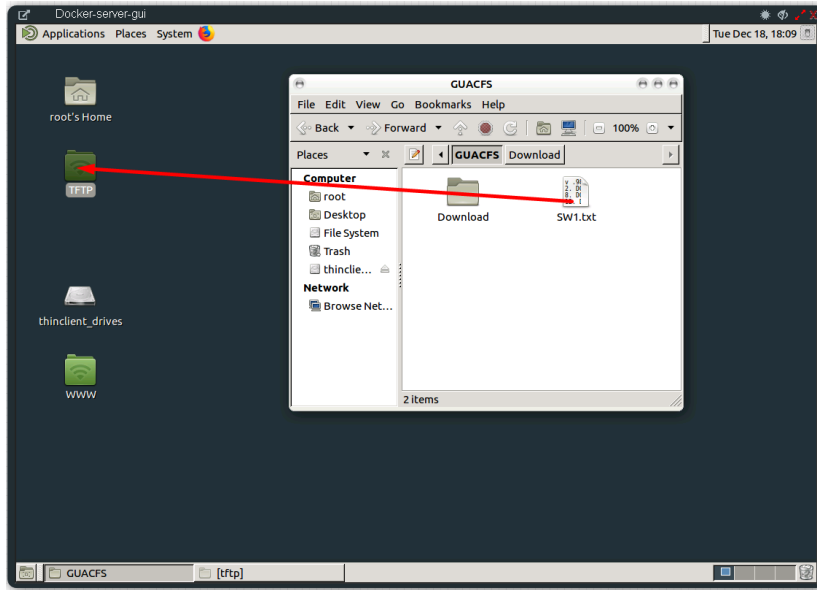

Step 4: Open the destination node's (R1) console and use the tftp command to copy your file:

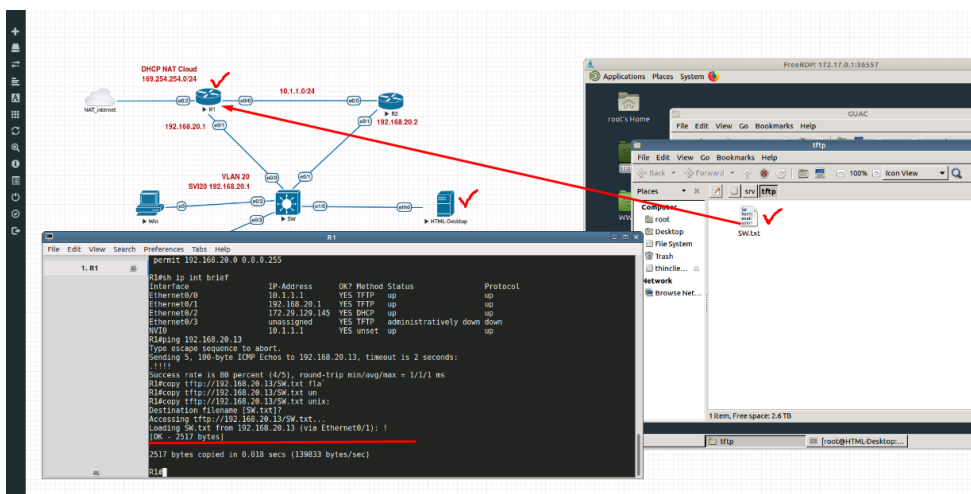

14 Dockers

14.1 EVE integrated docker stations

EVE-NG Professional and Learning Centre edition have integrated Docker stations that allows your server to use its resources more efficiently. Dockers offer the advantage of not having to duplicate processes already running on the host system. With a Docker, you run only the processes you need for the hosted application. In comparison, virtual machines have to run a complete guest operating system, including many of the same processes that are already running on the server host.

⚠ IMPORTANT NOTE: EVE Docker stations for html console access are using network 172.17.0.0/16. Please avoid use this network on the EVE management or other clouds or interfaces.

14.1.1 Docker Machines

eve-gui-server (default)

- Fully featured Linux workstation with integrated Thinclient. For more information on the Thinclient operation please refer to section [13](#).
- napalm
- ansible
- python
- RDP console
- DHCP or Static IP address
- WWW Server (web page home directory www is located on desktop)
- TFTP Server (for access to TFTP server, root/eve or nobody/eve, home directory TFTP is located on desktop)
- FTP server (for access to FTP server, root/eve, home directory for ftp is root)
- Java Integration for ASDM access to Cisco ASA/IPS. For access to ASDM where Java is required, please follow this reference link:

<https://192.168.100.5/admin/public/asdm.jnlp>

Where 192.168.100.5 is the ASA IP for ASDM connection

NOTE: Older ASA require to configure extra SSL encryption to communicate with Java on the docker station. ASA 9.1.5 CLI:

```
ssl encryption aes256-sha1
```

Example: Access to ASA/ ASDM from Docker server-gui station

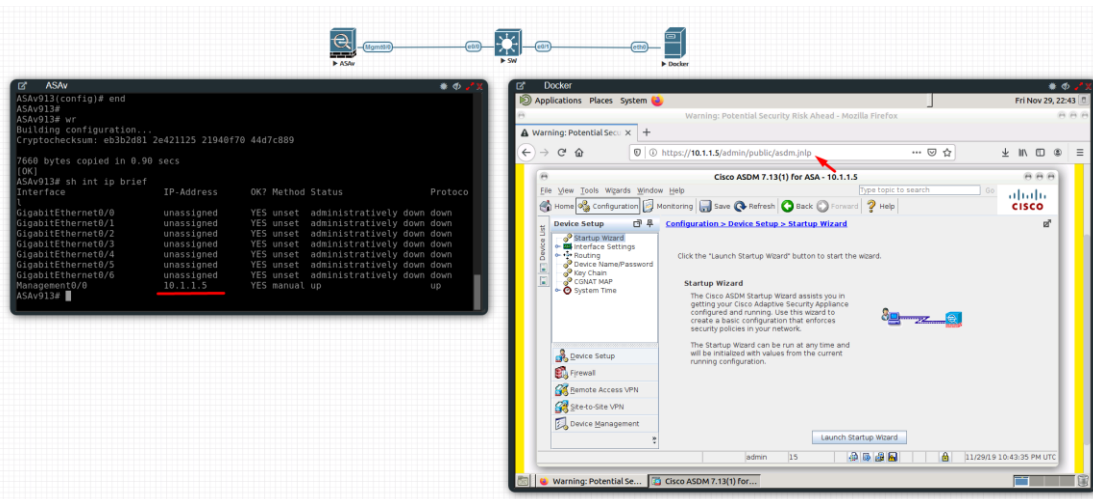

eve-firefox (default)

- A Docker for hosting a Mozilla Firefox browser. Useful for accessing another nodes management interface using http or https. The browser already has Java integrated so that you can utilize GUIs that require it, like ASDM for Cisco's ASA.
- RDP console
- DHCP or Static IP address

eve-wireshark (default)

- Fully featured Wireshark workstation with integrated Thinclient. For more information on the thinclient operation please refer to section 13.
- RDP console

eve-chrome (extra install, section 14.5)

- A Docker for hosting a Google Chrome browser. Useful for accessing another nodes management interface using http or https. The browser already has Java integrated so that you can utilize GUIs that require it, like ASDM for Cisco's ASA.
- DHCP or Static IP address

eve-kali-large (extra install, section 14.5)

- A Docker for hosting a Kali Linux. Fully featured Security vulnerability and penetration test machine
- DHCP or Static IP address
- Java Integration for ASDM access to Cisco ASA/IPS. For access to ASDM where Java is required, please follow this reference link:
- <https://192.168.100.5/admin/public/asdm.jnlp>
- Where 192.168.100.5 is the ASA IP for ASDM connection

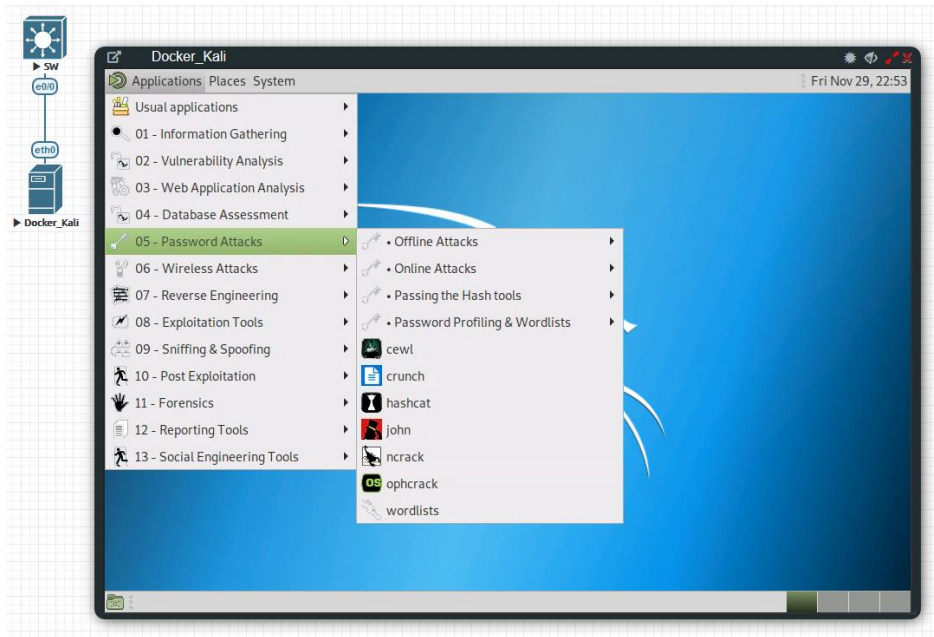

eve-ostinato (extra install, section 14.5)

- A Docker for hosting a Ostinato 0.9 GUI. Fully featured Ostinato 0.9 packet generator and network traffic generator machine
- DHCP or Static IP address
- Fully featured Ostinato GUI

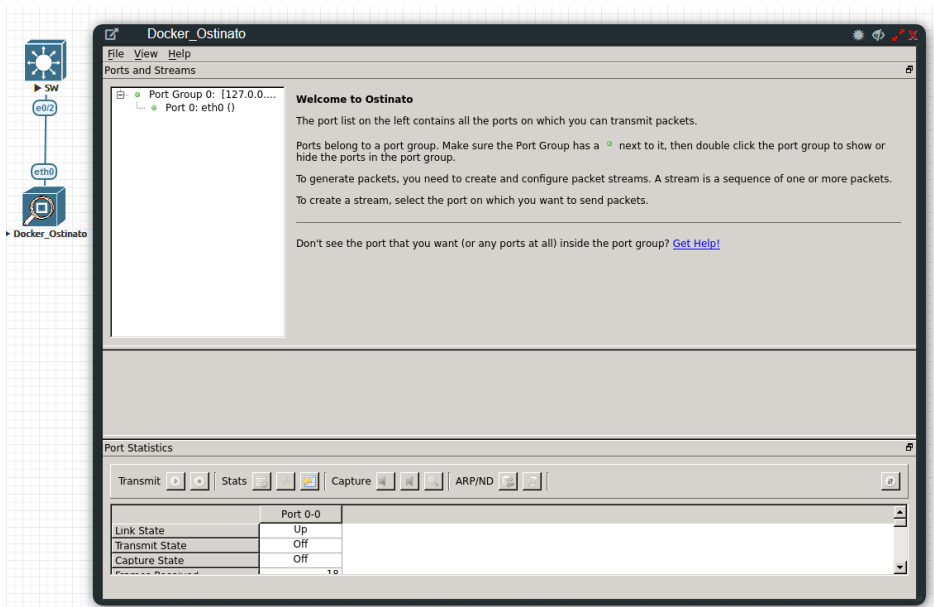

14.1.2 Docker DHCP IP address setup

EVE integrated Docker stations have two options for setting an IP address.

DHCP IP address option.

Step 1: Add the node to the topology and make sure the DHCP option is **enabled** under the edit node window. Refer to section 14.2 for the correct console type.

Step 2: Ensure the docker's DHCP request can reach a DHCP server either in your lab or externally through a Cloud Network like Cloud0.

14.1.3 Docker Static IP and MAC address setup

Step 1: Add the node to the topology and make sure the DHCP option is **disabled** under the edit node window Reference section 14.2 for the correct console type.

Step 2: On the left sidebar menu open Startup-config and use the example syntax below to set the ip for your Docker node. Make sure you are using the exact syntax for your static IP setup:

```
# Set ip address and Default route
ip addr add 10.100.100.103/24 dev eth0 || true
ip route add default via 10.100.100.1 || true

# Set DNS server
cat > /etc/resolv.conf << EOF
nameserver 8.8.8.8
EOF
```

Step 2.1 (Optional): On the left sidebar menu open Startup-config and use the example syntax below to set the custom MAC for your Docker node. Make sure you are using the exact syntax for your static MAC setup:

```
# Set ip address and Default route
ip link set dev eth0 address XX:XX:XX:XX:XX:XX || true
ip addr add 10.100.100.103/24 dev eth0 || true
ip route add default via 10.100.100.1 || true

# Set DNS server
cat > /etc/resolv.conf << EOF
nameserver 8.8.8.8
EOF
```

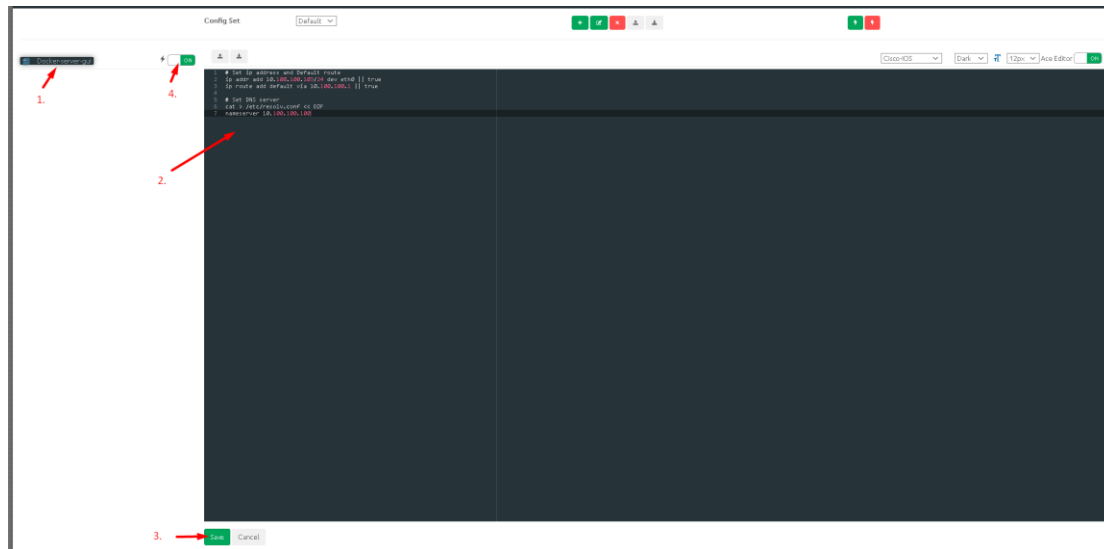

Step 3: Press the Save button below and switch the node to boot from the startup-config.

14.1.4 Docker multi interfaces setup

Step 1: Add the node to the topology and make sure the DHCP option is **disabled** under the edit node window Reference section 14.2 for the correct console type.

Step 2: On the left sidebar menu open Startup-config and use the example syntax below to set the ip for your Docker node. Make sure you are using the exact syntax for your static IP setup. It is recommended to add static routes under interfaces to reach specific networks if required.

```
# Set ip address eth0
ip addr add 192.168.1.200/24 dev eth0 || true
ip route add default via 192.168.1.1 || true

# Set ip address eth1
ip addr add 172.16.1.201/24 dev eth1 || true
# Set static route for eth1
ip route add 10.100.100.0/24 via 172.16.1.1 dev eth1 || true

# Set ip address eth2
ip addr add 10.1.1.10/24 dev eth2 || true
# Set static route for eth2
ip route add 10.10.10.0/24 via 10.1.1.1 dev eth2 || true

# Set DNS server
cat > /etc/resolv.conf << EOF
nameserver 8.8.8.8
EOF
```

14.1.5 Docker server-gui custom WEB page

Step 1: Add the node to the topology and make sure the DHCP option is **disabled** under the edit node window Reference section [14.2](#) for the correct console type.

Step 2: On the left sidebar menu open Startup-config and use the example syntax below to set the ip and html page for your Docker node. Make sure you are using the exact syntax for your static IP setup and custom HTML values:

```
# Set ip address and Default route
ip addr add 10.100.12.100/24 dev eth0 || true
ip route add default via 10.100.12.10 || true

# Set DNS server
cat > /etc/resolv.conf << EOF
nameserver 8.8.8.8
EOF

# Create a Default web page
# Use 'EOF' do avoid variable from expanding

# Delete default index page
rm /var/www/html/index.html || true

# Create a Default web page
# Use 'EOF' do avoid variable from expanding
cat > /var/www/html/index.php << 'EOF'
<center>
<?php
echo gethostname();
?>
<hr>

<hr>

<?php
//whether ip is from share internet
if (!empty($_SERVER['HTTP_CLIENT_IP']))
{
    $ip_address = $_SERVER['HTTP_CLIENT_IP'];
}
//whether ip is from proxy
elseif (!empty($_SERVER['HTTP_X_FORWARDED_FOR']))
{
    $ip_address = $_SERVER['HTTP_X_FORWARDED_FOR'];
}
//whether ip is from remote address
else
{
    $ip_address = $_SERVER['REMOTE_ADDR'];
}
echo 'Client Address:'. $ip_address;
?>
</center>
EOF
```

STARTUP-CONFIGS

Config Set: Default

SW1	ON
SW2	ON
Mgmt-Host	ON
ISP	ON
SW_M	ON
DMZ-S1	ON
DMZ-S2	ON
NTP	ON

```

1 # Set ip address and Default route
2 ip addr add 10.100.12.100/24 dev eth0 || true
3 ip route add default via 10.100.12.10 || true
4
5 # Create a Default web page
6 # Use 'EOF' do avoid variable from expanding
7
8 # Delete default index page
9 rm /var/www/html/index.html
10
11 # Create a Default web page
12 # Use 'EOF' do avoid variable from expanding
13 cat > /var/www/html/index.php << 'EOF'
14 <center>
15 <?php
16 echo gethostname();
17 ?>
18 <hr>
19 <img width="596" height="239" src="data:image/png;base64,iVBORw0KGpoAAAB
20 <hr>
21
22 <?php
23 //whether ip is from share internet
24 if (!empty($_SERVER['HTTP_CLIENT_IP']))
25 {
26     $ip_address = $_SERVER['HTTP_CLIENT_IP'];
27 }
28 //whether ip is from proxy
29 elseif (!empty($_SERVER['HTTP_X_FORWARDED_FOR']))
30 {
31     $ip_address = $_SERVER['HTTP_X_FORWARDED_FOR'];
32 }
33 //whether ip is from remote address
34 else
35 {
36     $ip_address = $_SERVER['REMOTE_ADDR'];
37 }
38 echo 'Client Address: '.$ip_address;
39 ?>
40 </center>
41 EOF

```

Step 3: Press the Save button below and switch the node to boot from the startup-config.

PoC FirePower ASAv FTD Active/Standby lab with ISE and SGT SXP
MAB and Dot1x users SGT tagging
Created by UD, EVE-NG, 2018

The screenshot shows the EVE-NG interface with a browser window open on the DMZ-S1 node. The browser address bar shows '10.100.12.100/'. The page content displays the EVE-NG logo and the text 'Emulated Virtual Environment Next Generation'. Below this, it shows 'Client Address: 10.100.12.100'. A red arrow points to the 'DMZ-S1' node in the network diagram above the browser window.

14.1.6 Docker server-gui SSL WEB page

Following previous chapter, you can enable on the server-gui node SSL/HTTPS certificate.

Step 1: Open Applications/System Tools/MATE Terminal

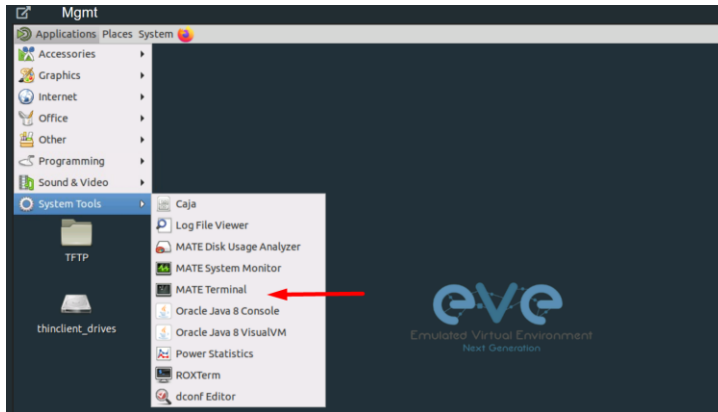

Step 2: Create SSL certificate, single line command, and fill up requested details.

```
openssl req -x509 -nodes -days 365 -newkey rsa:2048 -keyout /etc/ssl/private/apache-selfsigned.key -out /etc/ssl/certs/apache-selfsigned.crt
```

Step 3: Enable SSL certificate for web page.

```
/usr/sbin/a2enmod ssl  
/usr/sbin/a2ensite default-ssl
```

Step 4: Restart apache2 service

```
sv stop apache2  
sv start apache2
```

14.2 Docker Consoles

To set consoles for EVE Docker stations, right click on node and click Edit. Set the required console type

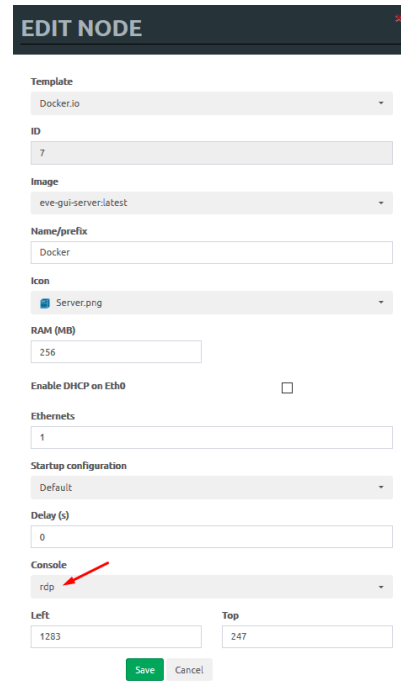
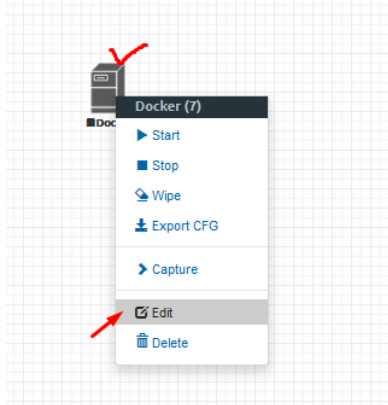

<i>Docker Station</i>	<i>Console type</i>
eve-gui-server (napalm, ansible)	RDP
eve-chrome (optional)	RDP
eve-wireshark	RDP
eve-firefox	RDP
eve-kali (optional)	RDP
eve-kali-large (optional)	RDP
eve-ostinato (optional)	RDP

14.3 Docker cli root access

All EVE docker stations have the following configured CLI root account.

Username: root

Password: eve

! NOTE: The root login for SSH can be commented in sshd file. Use vi to edit and remove comment “#” for PermitRootLogin

```
vi /etc/ssh/sshd_config
PermitRootLogin yes
```

Regular user (root user) SSH access to EVE Docker:

Username: nobody

Password: eve

14.4 Dockers re-install/update

To install or fix docker stations in the EVE Pro issue the following commands from the CLI of EVE.

When dockers are properly installed, your EVE CLI command `dc images` output must show:

```
root@eve-ng:~# dc images
REPOSITORY          TAG          IMAGE ID      sk 1    CREATED      50 GB      SIZE
eve-desktop         latest      ca1333621bd7  sk 1    12 hours ago  3.65GB
eve-gui-server      latest      9db19c879a17 controller 2 days ago  USB 2.0    3.84GB
eve-firefox         latest      0266d108a1bb  sk 1    7 weeks ago   2.12GB
eve-wireshark       latest      82a009773e89  sk 1    7 weeks ago   VM Manager 1.56GB
root@eve-ng:~#
```

If you still see some docker line with <none>

```
root@eve-ng:~# dc images
REPOSITORY          TAG          IMAGE ID      CREATED      SIZE
<none>              <none>      cc286e6ac274  16 seconds ago  1.87GB
eve-gui-server      latest      f3aa6e0e9a56  3 minutes ago   3.04GB
eve-wireshark       latest      638ed7cf5b80  12 minutes ago  887MB
eve-firefox         latest      259293d73b07  13 minutes ago  1.49GB
eve-desktop         latest      78e9c2e618a5  15 minutes ago  2.79GB
```

please use reinstall dockers command:

```
apt install --reinstall eve-ng-dockers
```

Reference for Dockers reinstall and upgrade: <http://www.eve-ng.net/documentation/eve-ng-upgrade>

14.5 Extra docker packages

NOTE: Not included in the default EVE Pro installation. This can take some time depending on your Internet connection and disk speed.

Kali Linux Full, to install issue command:

```
apt update
apt install eve-ng-kali-large
```

Chromium Linux http, to install issue CLI command:

```
apt update
```

```
apt install eve-ng-chrome
```

Ostinato docker, to install issue CLI command:

```
apt update
apt install eve-ng-ostinato
```

Docker-in-docker (DinD) docker. This docker is dedicated for complex docker stacks. Refer section: **14.6.2**. To install issue CLI command:

```
apt update
apt install eve-ng-dind
```

To verify Installed dockers, issue CLI command

```
dc images
root@eve-ng:~# dc images
REPOSITORY          TAG          IMAGE ID          CREATED           SIZE
eve-dind             latest      6e067b53b145     3 days ago       747MB
eve-gui-server       latest      0c764bb836f9     2 months ago     3.69GB
eve-kali-large       latest      6982b7fa25e1     2 months ago     11.8GB
eve-wireshark        latest      413aae02d43d     4 months ago     1.62GB
eve-firefox          latest      8882ac260c1f     4 months ago     2.15GB
eve-ostinato         latest      63497fd2da4d     4 months ago     1.79GB
eve-desktop          latest      b041a187ded9     4 months ago     3GB
dockergui-rdp        latest      be03f3b46439     4 months ago     1.29GB
root@eve-ng:~#
```

14.6 Third parties dockers

Starting EVE-NG Pro version 2.0.6-52, the third party dockers can be installed on the EVE. However, some limitation still exists. You are free to evaluate by yourself if a specific one is working.

Two main categories of dockers require each a specific method for EVE integration:

- ❖ Simple Docker
- ❖ Docker's Stack

14.6.1 Simple docker installation

Simple docker is the classic docker running in a standalone mode. You could find large choice of docker images on <https://hub.docker.com> or create the Docker by yourself.

Complete guide about dockers can be found on <https://docs.docker.com/>

Note: Internet access is a must. For simple docker, you only have to use:

```
dc pull <dockername>
```

Note: "dc" is EVE-NG alias for docker -H tcp://127.0.0.1:4243 which simplify docker operations in the EVE.

Once your new docker is pulled, you are able to use it in EVE-NG topologies. EVE-NG will start it using correct parameters automatically.

Example: SSH to your EVE. Install adosztal AAA docker:

```
root@eve-ng:~# dc pull adosztal/aaa
```

```
root@eve-ng:~# dc images
REPOSITORY          TAG          IMAGE ID          CREATED          SIZE
eve-dind             latest      6e067b53b145     3 days ago      747MB
adosztal/aaa        latest      862d42a1c8f5     8 weeks ago     311MB
eve-gui-server      latest      0c764bb836f9     2 months ago    3.69GB
eve-kali-large       latest      6982b7fa25e1     2 months ago    11.8GB
eve-wireshark        latest      413aae02d43d     4 months ago    1.62GB
eve-firefox          latest      8882ac260c1f     4 months ago    2.15GB
eve-ostinato         latest      63497fd2da4d     4 months ago    1.79GB
eve-desktop          latest      b041a187ded9     4 months ago    3GB
dockergui-rdp        latest      be03f3b46439     4 months ago    1.29GB
root@eve-ng:~#
```

New docker use: Open a new lab, add docker and select adosztal/aaa with console in tenet mode.

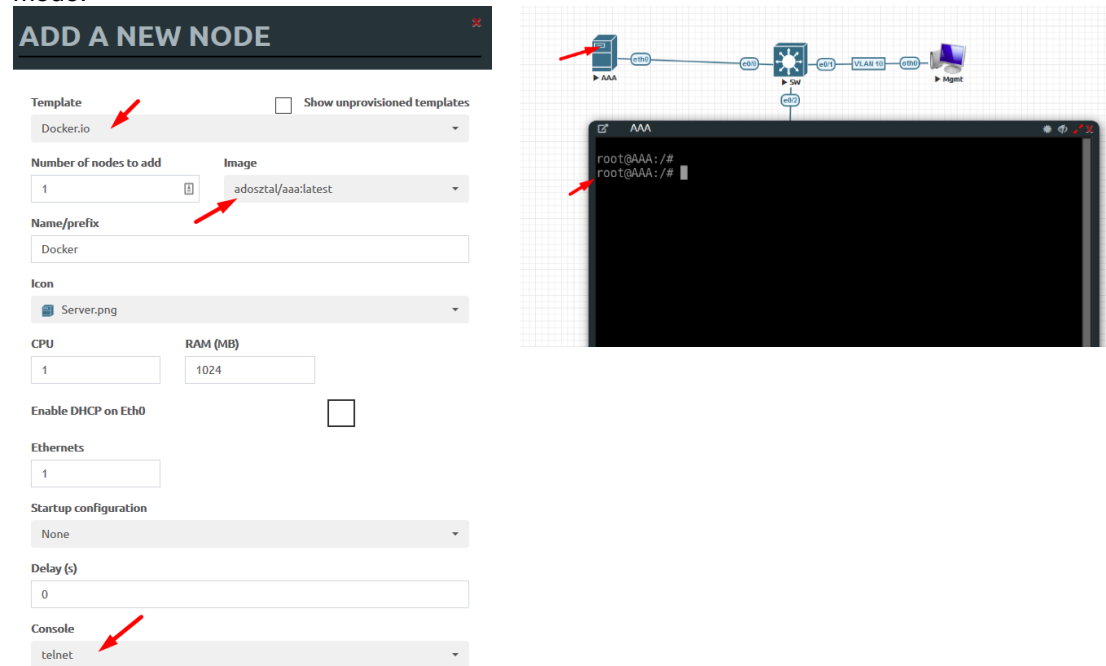

14.6.2 Docker stack installation

Docker's Stack is a complex structure of multi intercommunicating dockers. For example, a Web service docker is using another Database Docker service.

To avoid involve EVE host internal process and network, the new add-on docker is provided: "eve-dind". This add-on is a dedicated docker container allowing to build complex stack. The classic method is based on docker-compose.

The example below illustrates how to build complex docker LibreNMS, Network Management System.

Note: Internet access is a must. SSH to your EVE as root.

Sample:

Step 1: On eve cli, type:

```
apt update
apt install eve-ng-dind
```

Note: install eve-ng-dind add-on docker and is required only once.

Step 2: Create a new lab

Step 3: Add on the lab:

- a. NAT network
- b. Docker eve-dind (set console to 'telnet' and enable dhcp)

Step 4: Connect docker to NAT network

Step 5: Start Docker

Step 6: Open Docker Console

Step 7: Type in console:

```
git clone https://github.com/librenms/docker.git librenms-src
cp -r librenms-src/examples/compose librenms
rm -fr librenms-src
cd librenms
docker-compose up -d
```

Commit your created docker with new name.

Step 8: Open a cli access to your [EVE server](#)

Step 9: Type within the EVE cli:

Find your current running container ID using eve-dind image

```
dc ps -a
```

```
root@eve-ng:~# dc ps -a
CONTAINER ID   IMAGE                                COMMAND                  CREATED        STATUS
PORTS         NAMES
b96743436dd8  eve-dind:latest                    "dockerd-entrypoint.â€¦" About a minute ago Up About a minute
9a4f9db1-4ab2-4e8c-b066-0d25ceeb540b-10-4  eve-gui-server:latest              "/sbin/my_init"        10 hours ago  Up 10 hours
7d83609410aa  eve-gui-server:latest              "/sbin/my_init"        10 hours ago  Up 10 hours
9a4f9db1-4ab2-4e8c-b066-0d25ceeb540b-10-2  eve-gui-server:latest              "/sbin/my_init"        10 hours ago  Up 10 hours
13ee6dc804ae  eve-gui-server:latest              "/sbin/my_init"        8 days ago    Exited (0) 16 hours ago
dd700ee7-f03b-4fd5-8ed8-40d1ad2e6f4f-10-14  eve-gui-server:latest              "/sbin/my_init"        8 days ago    Exited (0) 16 hours ago
```

Step 10: **IMPORTANT:** On the Lab UI stop docker. Do not wipe, but stop.

Step 11: Commit your created docker with custom name.

```
dc commit <containerid> eve-librenms
```

Step 12: On LAB UI: Stop all nodes, Close Lab, Delete Lab

Note, when you add newly created docker in lab, use vendor advised settings, x4 CPU and 8GB Ram for librenms docker. Console: Telnet. Graphic Interface https.

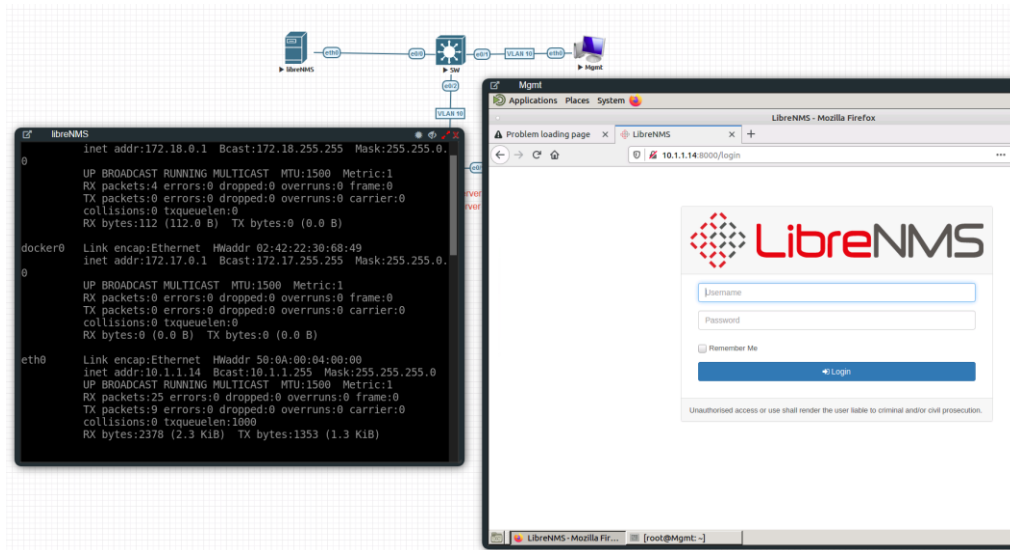

14.7 Customize docker image with your own changes.

Step 1. Connect your existing docker node to the internet

Sometimes you may have your own packages to be installed on the docker and kept for future labs. For this connect your docker to the Internet. It can be achieved connecting docker to Management Cloud0 or NAT cloud. **Example below**, Sever-gui docker is connected to Cloud NAT.

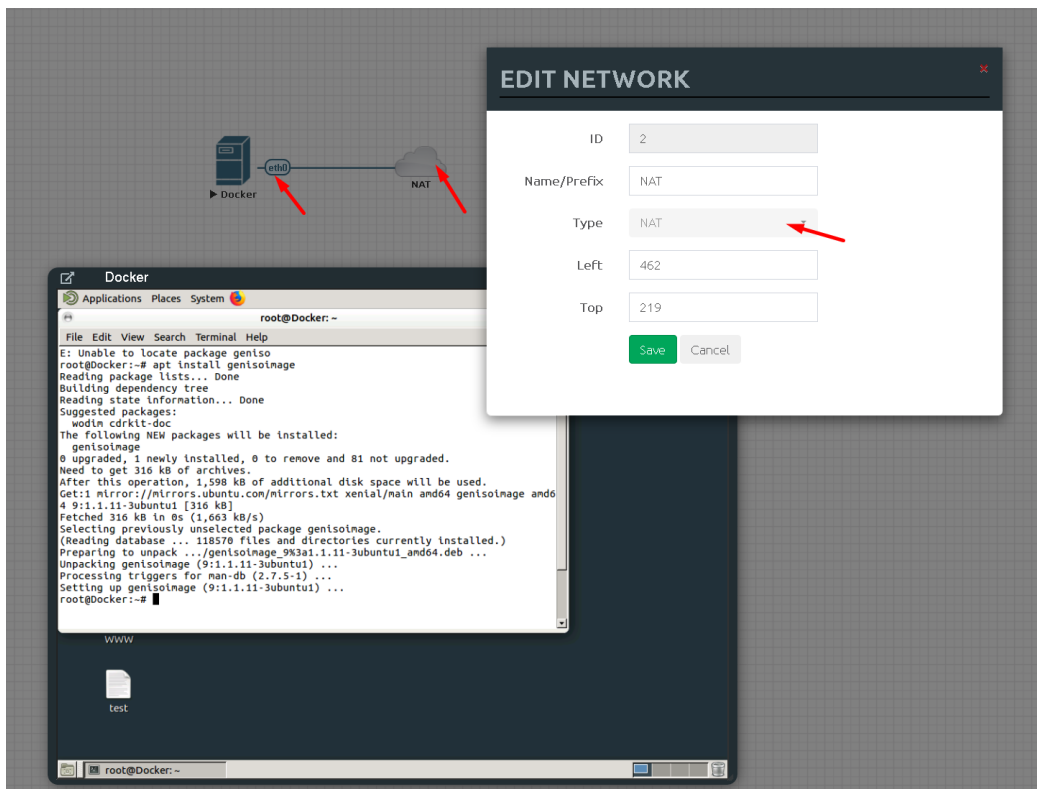

Step 2. Make your installs, packages. Example:

In the screen above I did install genisoimage package

```
apt install genisoimage
```

Step 3. Obtain your RUNNING docker container ID:

From EVE CLI issue command:

```
dc ps
```

```
root@eve-ng:~# dc ps
CONTAINER ID   IMAGE                                COMMAND                  CREATED        STATUS        PORTS
NAMES
0d4b3f8c314c  eve-gui-server:latest              "/sbin/my_init"        33 hours ago  Up 2 minutes
b37bf9cb-0c6f-4bcb-b838-10d877ecce78-10-5  packages.Example
root@eve-ng:~# ^C
root@eve-ng:~#
In the screen above I did install the genisoimage package
```

Step 4. Commit your prepared docker image with new name. example below I called it eve-geniso

```
dc container commit <containerid> <newimagenam>
```

```
dc container commit 0d4b3f8c314c eve-geniso
```

Step 5 check if new Docker image is created

```
dc images
```

```
root@eve-ng:~# dc images
REPOSITORY    TAG          IMAGE ID          CREATED          SIZE
eve-geniso    latest      e6dd56c3b26c    4 seconds ago   3.19GB
eve-kali      latest      d1fda568e8a0    3 weeks ago     4.77GB
eve-nso      latest      f2a7a3d6a423    8 weeks ago     3.95GB
eve-ostinato latest      e89cad6b1813    2 months ago    1.34GB
eve-gui-server latest      a13cb401c8dd    3 months ago    3.11GB
eve-firefox   latest      8900664e9f3b    4 months ago    1.49GB
eve-chrome    latest      51fd92216b99    4 months ago    1.61GB
eve-wireshark latest      0c49fe2dc6bb    7 months ago    888MB
eve-desktop   latest      c285d1ec833c    7 months ago    2.39GB
dockergui-rdp latest      a65b62fa69b6    9 months ago    553MB
phusion/baseimage 0.9.22     877509368a8d    2 years ago     225MB
root@eve-ng:~#
```

Step 6. Optional, If you want to keep this image and later load in other EVE installs, then you must create exportable .tar image.

```
dc image save -o /root/mysuperimage.tar <image name>
```

Step 7 Optional, upload your .tar file in new EVE root, and install it in Dockers location.

```
dc image load -i /root/mysuperimage.tar
```

14.8 Delete docker image from EVE

Step 1. From EVE CLI issue command to check docker ID to be removed.

```
dc images
```

```
root@eve-ng:~# dc images
REPOSITORY    TAG          IMAGE ID          CREATED          SIZE
eve-geniso    latest      e6dd56c3b26c    4 seconds ago   3.19GB
eve-kali      latest      d1fda568e8a0    3 weeks ago     4.77GB
eve-nso      latest      f2a7a3d6a423    8 weeks ago     3.95GB
eve-ostinato latest      e89cad6b1813    2 months ago    1.34GB
eve-gui-server latest      a13cb401c8dd    3 months ago    3.11GB
eve-firefox   latest      8900664e9f3b    4 months ago    1.49GB
```

Step 2. Use command: **dc rmi -f <id of docker image>**.

```
dc rmi -f e6dd56c3b26c
```

Step 3. Check with **dc images** if docker is removed.

Step 4. Finish removal with **apt remove --purge eve-ng-kali**, where eve-ng-kali is your docker repository name.

15 EVE Cluster System

The EVE-NG cluster refers to a group of EVE-NG nodes working together as a single entity to provide users with better scalability and availability.

The EVE-NG cluster model is designed to work as a one + many systems, the EVE-NG management server is acting as "Master" node, EVE-NG installations as "Satellite" can be members of this cluster.

One "Master" EVE-NG can have several satellites joined into its cluster but each satellite can only be joined to one Cluster/Master.

Any existing EVE-NG Pro installation is already a EVE-NG "Master", cluster members will need to be installed as "satellite" and can then easily be joined.

15.1 EVE Cluster design models

15.1.1 Bare metal servers cluster

Design 1 EVE-NG Cluster Bare HW servers, recommended

EVE Cluster 208 vCPU, 896GB RAM, 16TB SSD. Cluster members can be different HW configuration. The 1GB LAN connection or better is required

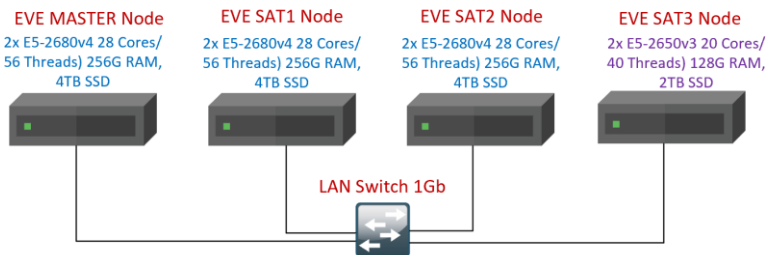

15.1.2 ESXi Virtual Machines cluster

Design 2 EVE-NG Cluster VM Ware ESXi Virtual Machines

EVE Virtual ESXi Cluster 112 vCPU, 384GB RAM, 8TB SSD. Cluster members can be different VM configuration and located on same or different ESXi servers

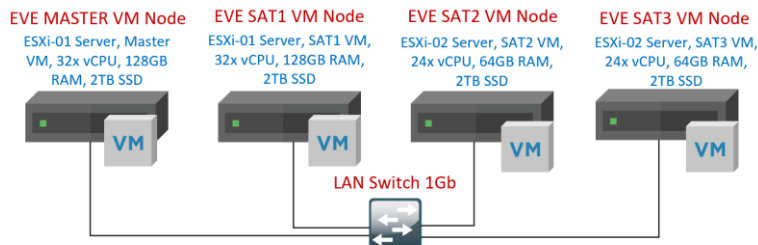

15.1.3 Hybrid cluster

Design 3 Hybrid EVE-NG Cluster Bare metal and VM Ware ESXi Virtual Machines

EVE Hybrid Bare HW and ESXi Cluster 120 vCPU, 384GB RAM, 6TB SSD. Cluster members can be different VM configuration and located on same or different ESXi servers

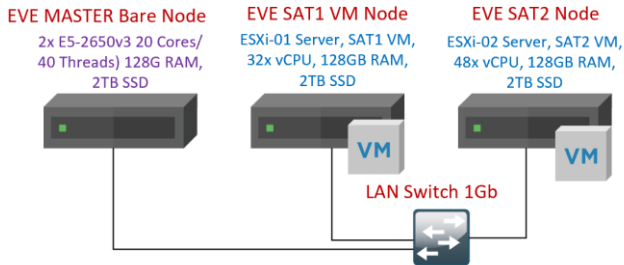

15.1.4 VM Ware workstation light cluster

Design 4 Light EVE-NG Cluster Desktop PCs and Wifi Laptop with VM Ware workstation and Virtual Machines

Light EVE Cluster with Desktop PCs and Laptop Wifi.

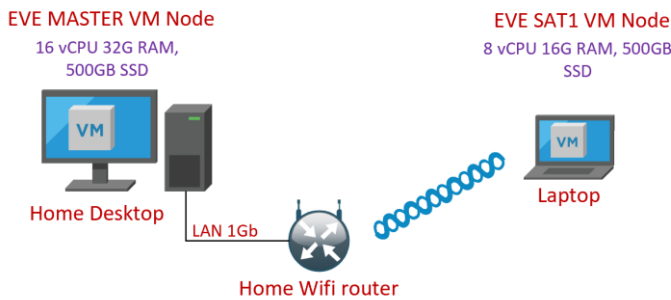

15.1.5 Google Cloud cluster

NOTE: Your EVE VM must have Public IP address to join GCP satellite

Design 5 EVE-NG Cluster Desktop PCs VM Ware workstation VM and Google Cloud VMs

High speed internet is required

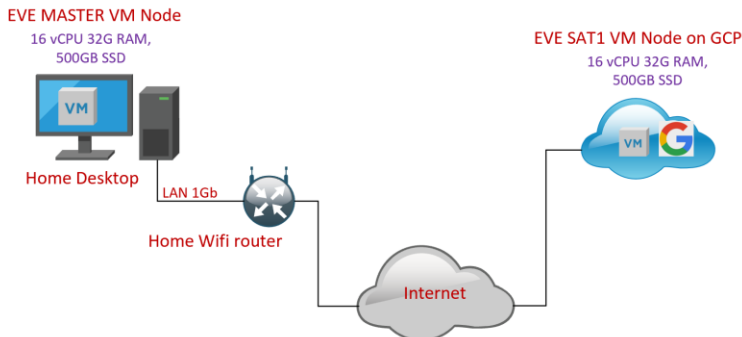

15.2 EVE Cluster pre-requisites

15.2.1 Firewall rules between Master and Satellite nodes

Node	Protocol	Port	Direction	Source	Destination
MASTER	TCP	22	ingress and egress	MASTER node IP	SATELLITE nodes IPs
MASTER	UDP	all	ingress and egress	MASTER node IP	SATELLITE nodes IPs
SATELLITE	TCP	22	ingress and egress	SATELLITE node IP	MASTER Node IP
SATELLITE	UDP	all	ingress and egress	SATELLITE node IP	MASTER Node IP

15.2.2 EVE Cluster internal management network

An EVE Cluster for internal management is using network **172.29.130.0/24**. Please avoid use it in your network

15.2.3 EVE Cluster Member's hardware requirements

Any suitable Hardware or virtual device. Please refer Chapter **2**

15.2.4 NTP Synchronization requirements

It is mandatory that during install your cluster Satellite member have same time NTP synchronization as the Master server.

15.3 EVE Cluster MASTER Node Installation

- ⚠ **Mandatory Prerequisites:** Internet must be reachable and DNS must resolve from your EVE Server. EVE ISO installation requires internet access and DNS to get updates and install the latest EVE-PRO version from the EVE-NG repository, to check it, do a named ping, for example ping www.google.com
- ⚠ It is mandatory that during install your cluster Satellite member have same time NTP synchronization as the Master server.

Any existing EVE-NG Pro installation is already a EVE-NG "Master", cluster members will need to be installed as "Satellite" and then can be easily joined. Please refer Chapter 3

15.4 ESXi EVE Satellite VM installation

Download EVE-NG Professional ISO distribution image:
<https://www.eve-ng.net/index.php/download/>

15.4.1 EVE-NG Satellite ESXi VM Setup and Settings

Step 1: Upload EVE ISO image to the ESXi store.

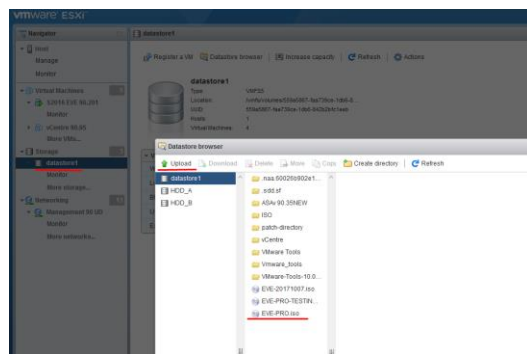

Step 2: Create NEW VM

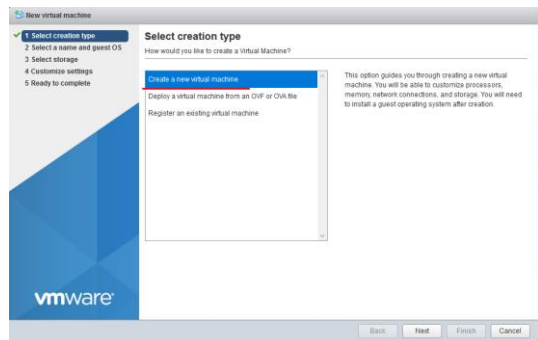

Step 3: Enter the name for your EVE-SAT01 VM and select Guest Operating system Linux and version: Ubuntu 64-bit

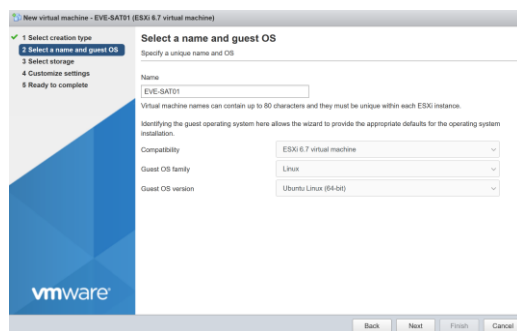

Step 4: Select Location where your EVE VM will be stored in HDD.

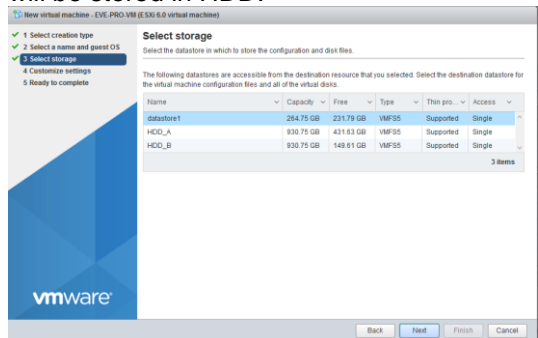

Step 5: **IMPORTANT** Customize your EVE VM CPU Settings. Set CPU Number of Cores and number of cores per processor. Set Intel VT-x/EPT Virtualization to ON (checked).

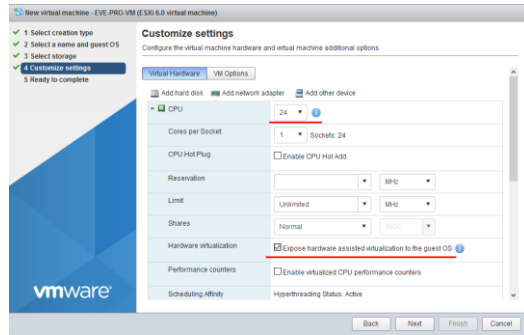

Step 6: Assign desirable RAM for your EVE Satellite

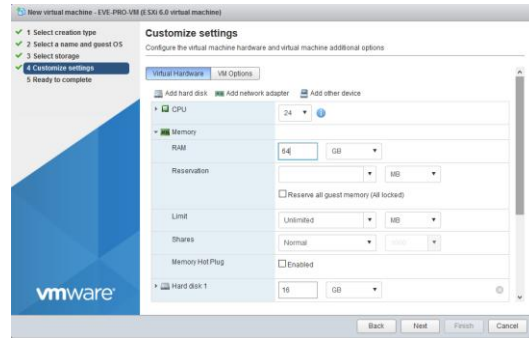

Step 7: Set the size of HDD for your new EVE Satellite VM. It is recommended to set "Thick Provisioned eagerly provisioned". Server EVE HDD is recommended to set at least 500Gb

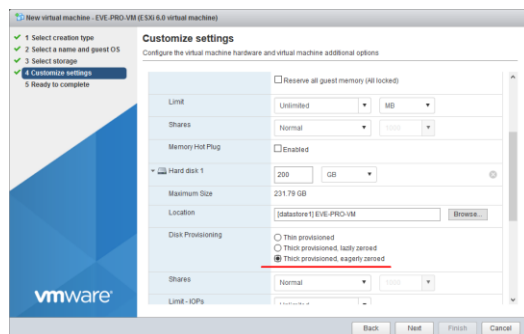

Step 8: Set your Management network. Adapter type VMXNET3

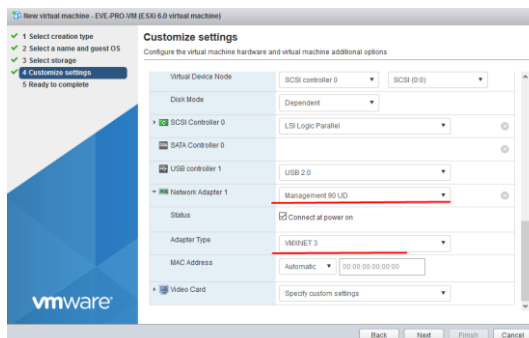

Step 9: Add new device to your EVE VM, CD/DVD

Step 10: Set DVD drive to "Datastore ISO File" and browse your uploaded EVE-PRO.iso. Make sure that Status is checked ON, "Connect at power on"

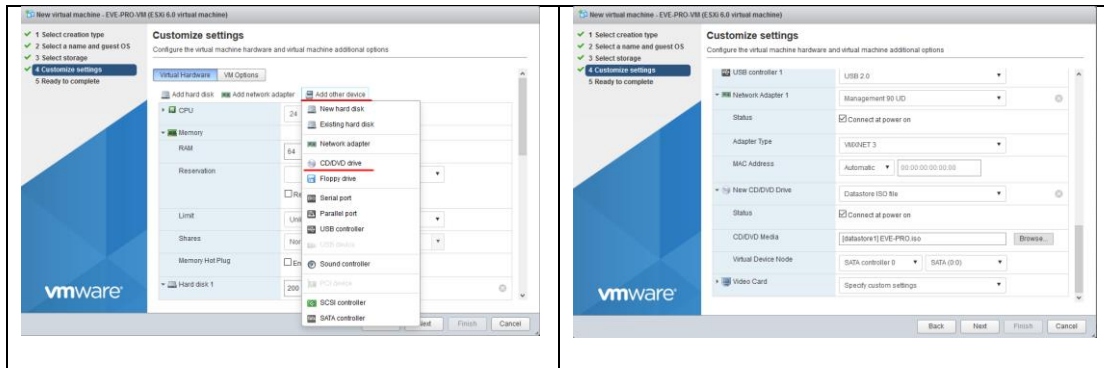

15.4.2 EVE-NG Satellite ESXi VM Installation steps

⚠ Mandatory Prerequisites: Internet must be reachable from your PC and VMware. EVE ISO installation requires internet access to get updates and install the latest EVE-PRO version from the EVE-NG repository. DNS must work as well, to check it, do a named ping, for example ping www.google.com

Satellite EVE ESXi VM Installation from ISO has 3 Phases

Phase 1 (Ubuntu installation)

Step 1: Power ON EVE VM. Chose Install EVE Satellite and confirm with Enter.

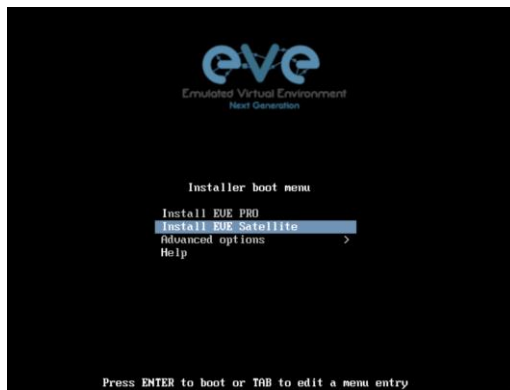

Step 2: Select English language. Confirm with Enter.

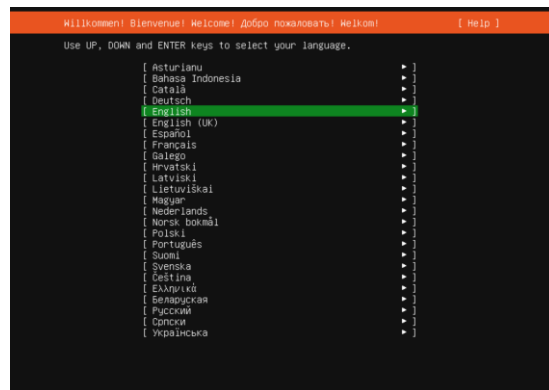

Step 3: Make sure if English US keyboard is selected and confirm with Enter.

Step 4: If your network has **DHCP ENABLED**, Continue to **Step 10**

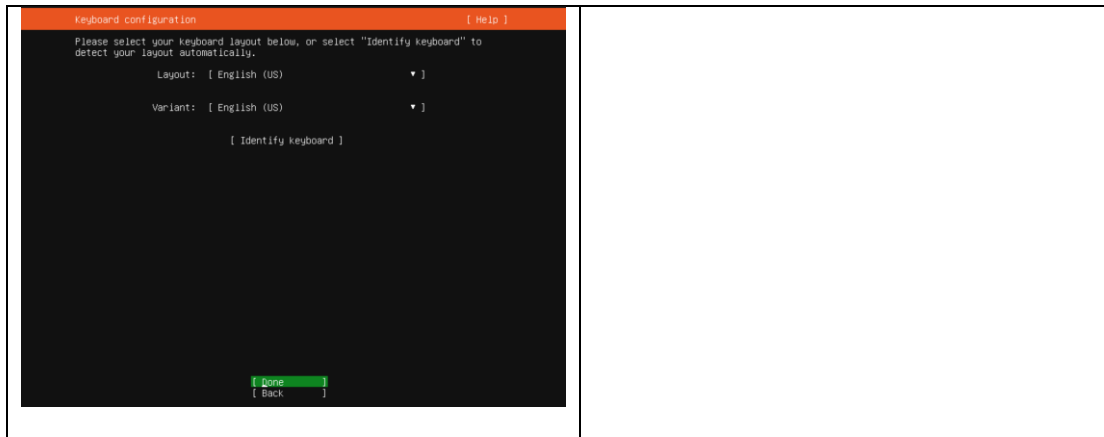

Step 5: If your network has not **DHCP**. Static IP setup. If you have not enabled DHCP in the network, you must assign an IP address manually. Use arrow UP key to select your interface for IP address assignment.

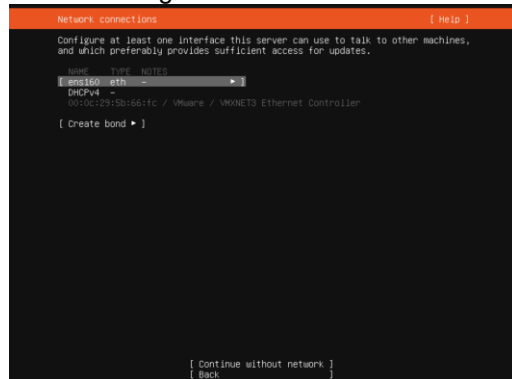

Step 6: Confirm interface selection with Enter, select "Edit IPv4" and confirm with Enter again.

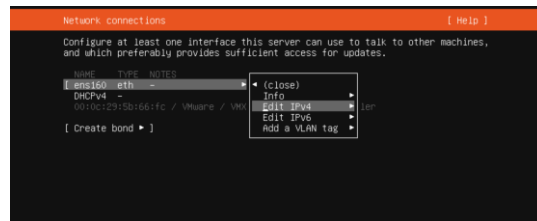

Step 7: Hit Enter on IPv4 Method and select "Manual", confirm with Enter.

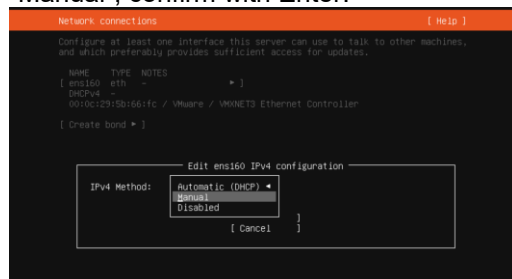

Step 8: Enter your "Subnet", "IP Address", "Gateway IP", "Domain server IPs" and "Search domain". Select "Save" and confirm with Enter. **NOTE, it is very important that your DNS (Name servers) will resolve**

Internet names.

Step 9: Select "Done" and confirm with Enter

Step 10: If your DHCP IP settings are correct, select Done and confirm with Enter.

Step 11: If you have proxy in use for your internet, assign your network proxy settings. If no proxy in use, with Tab key select Continue and confirm with Enter.

Step 12: Select "Continue" and confirm with Enter.

Step 19: On the EVE CLI prompt, reboot EVE by typing

```
reboot
```

NOTE: To verify your EVE Satellite server installation type “dpkg -l eve-agent” it should display latest EVE Agent/Satellite version:

```
root@eve-sat01:~# dpkg -l eve-agent
Desired=Unknown/Install/Remove/Purge/Hold
|          Status=Not/Inst/Conf-files/Unpacked/halF-conf/Half-inst/trig-aWait/Trig-pend
|/ Err?=(none)/Reinst-required (Status,Err: uppercase=bad)
||/ Name                Version             Architecture        Description
+++-----
ii  eve-agent              5.0.1-10           amd64               Agent
for EVE-NG Sat Cluster member
root@eve-sat01:~#
```

NOTE: If your newly installed satellite shows nothing like above, you must check your internet reachability and verify DNS configuration on your Satellite server.

```
root@eve-sat01:~# ping www.google.com
PING www.google.com (172.217.22.164) 56(84) bytes of data.
64 bytes from arn09s11-in-f164.1e100.net (172.217.22.164): icmp_seq=1
ttl=120 time=8.84 ms
64 bytes from arn09s11-in-f164.1e100.net (172.217.22.164): icmp_seq=2
ttl=120 time=8.84 ms
^C
--- www.google.com ping statistics ---
2 packets transmitted, 2 received, 0% packet loss, time 1001ms
rtt min/avg/max/mdev = 8.848/8.848/8.849/0.094 ms
root@eve-sat1:~#
```

Launch Satellite installation manually

```
root@eve-sat01:~# cd /etc
root@eve-sat01:~# ./eve-setup
```

15.5 Bare metal server EVE Satellite installation

Download EVE ISO distribution image:
<https://www.eve-ng.net/index.php/download/>

⚠ Mandatory Prerequisites: Internet must be reachable from your Server. This ISO installation requires internet access to get updates and install the latest EVE-PRO version from the EVE-NG repository. DNS must resolve names!

15.5.1 Ubuntu Server Installation Phase 1

Phase 1 (Ubuntu installation)

Step 1: Power ON EVE VM. Chose Install EVE Satellite and confirm with Enter.



Step 2: Select English language. Confirm with Enter.

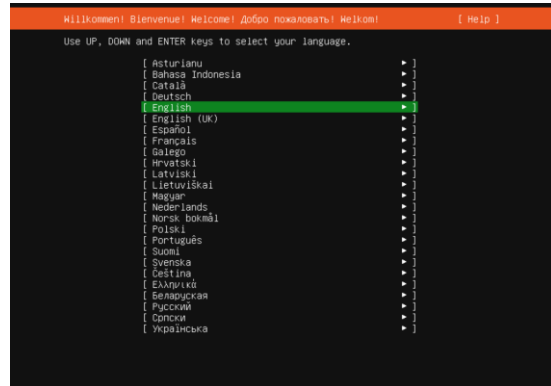

Step 3: Make sure if English US keyboard is selected and confirm with Enter.

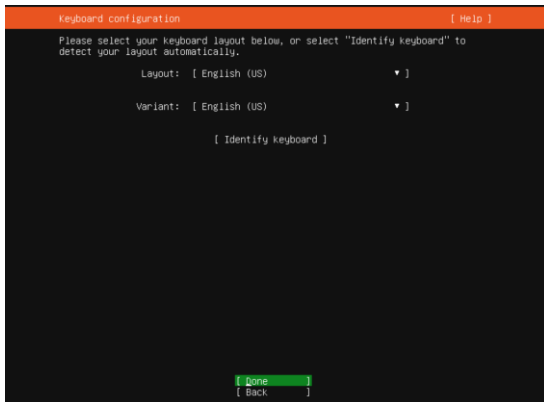

Step 4: If your network has **DHCP ENABLED**, Continue to **Step 10**

Step 5: If your network has not **DHCP**. Static IP setup. If you have not enabled DHCP in the network, you must assign an IP address manually. Use arrow UP key to select your interface for IP

Step 6: Confirm interface selection with Enter, select "Edit IPv4" and confirm with Enter again.

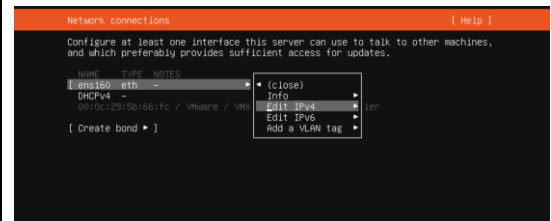

address.assignment.

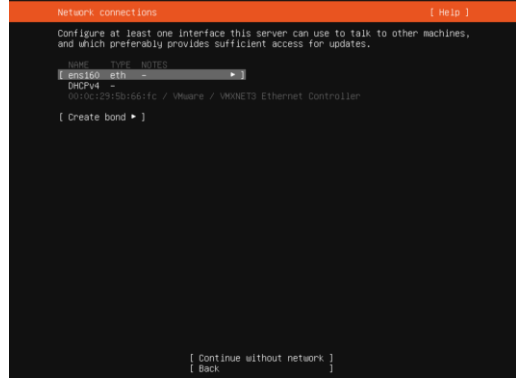

Step 7: Hit Enter on IPv4 Method and select "Manual", confirm with Enter.

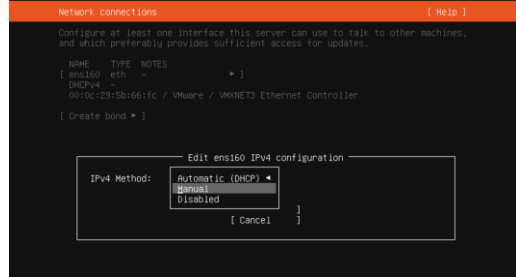

Step 8: Enter your "Subnet", "IP Address", "Gateway IP", "Domain server IPs" and "Search domain". **NOTE, it is very important that your DNS (Name servers) will resolve Internet names.**

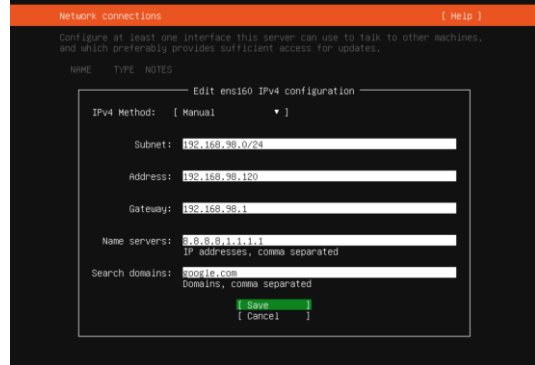

Step 9: Select "Done" and confirm with Enter

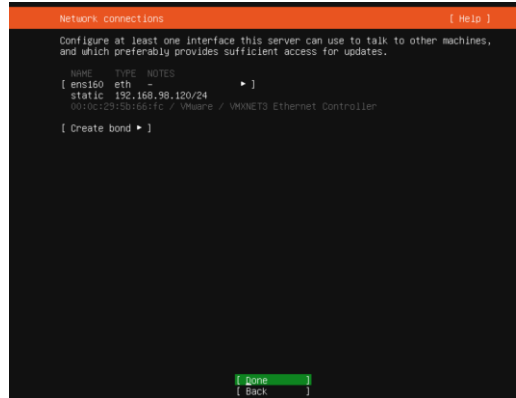

Step 10: If your DHCP IP settings are correct, select Done and confirm with Enter.

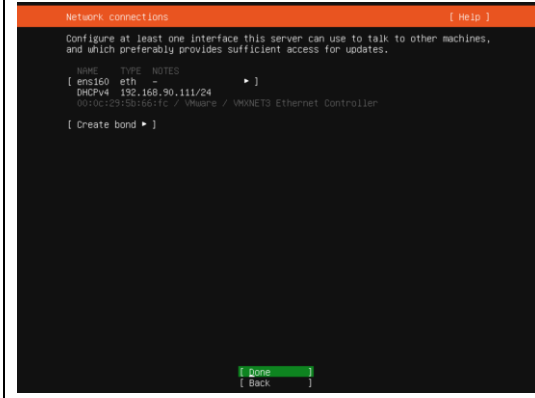

Step 11: If you have proxy in use for your internet, assign your network proxy settings. If no proxy in use, with Tab key select Continue and confirm with Enter.

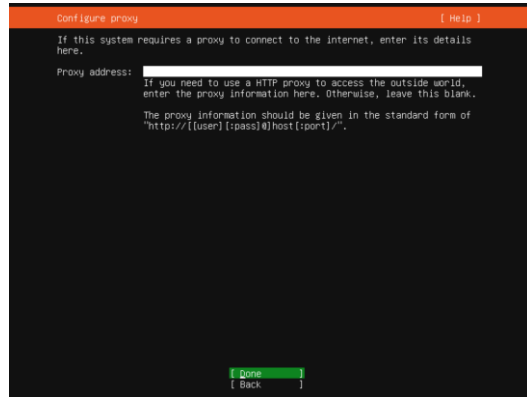

Step 12: Select "Continue" and confirm with Enter.

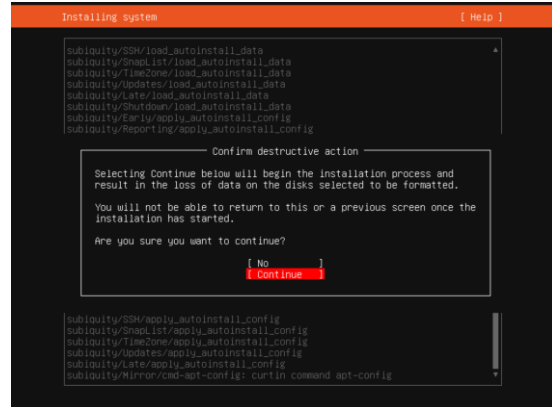

EVE Satellite Installation Phase 2 (EVE Satellite installation)

Step 13: After the Ubuntu "Install Complete" select "Reboot Now" and hit Enter to continue.

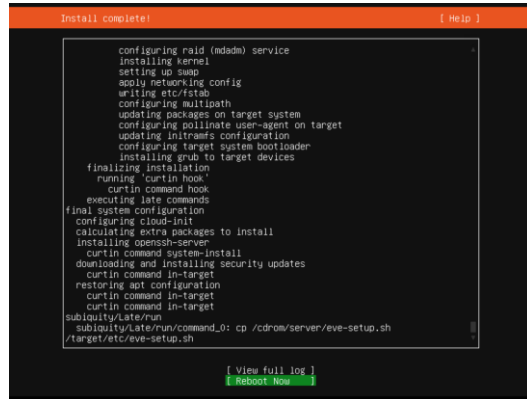

Step 14: Without powering off the EVE Server remove CD/DVD ISO Media

Step 15: Return back to EVE console screen and confirm Continue with Enter, EVE VM

Step 16: Depending on your internet speed EVE installation will take some time. After installation EVE VM will auto reboot and EVE login screen will appear, login in CLI with

Step 30: After your Satellite is rebooted, login to the Satellite CLI and type:

```
apt update
apt upgrade
```

15.6 Google Cloud EVE Satellite installation

Pre-Requisites: Your EVE must have Public IP address or static NAT to public IP.

15.6.1 Preparing Ubuntu boot disk template

Step 1: Navigate: Navigation Menu/Compute Engine/VM Instances

Step 2: Open the google cloud shell and press: "START CLOUD SHELL"

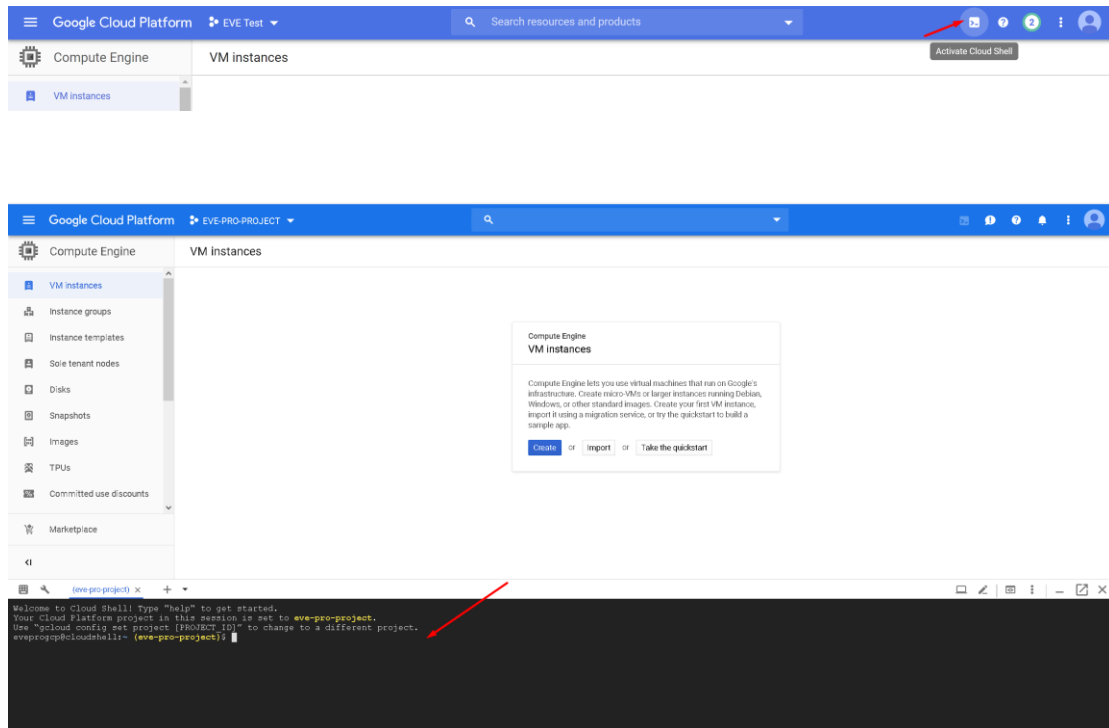

Step 3: create a nested Ubuntu 20.04 image model. Copy and paste the below command into the shell. Use copy/paste. ctrl +c/ctrl +v. **It is single line command (copy all command below in cli).** Confirm with "enter":

```
gcloud compute images create nested-ubuntu-focal --source-image-family=ubuntu-2004-lts --source-image-project=ubuntu-os-cloud --licenses https://www.googleapis.com/compute/v1/projects/vm-options/global/licenses/enable-vmx
```



You will get the following output when your image is ready:

```

CLOUD SHELL
Terminal (eve-test-276509) x +
Welcome to Cloud Shell! Type "help" to get started.
Your Cloud Platform project in this session is set to eve-test-276509.
Use "gcloud config set project [PROJECT ID]" to change to a different project.
uidls_dzorkale@cloudshell:~$ gcloud compute images create nested-ubuntu-bionic --source-image-family-ubuntu-1804-lts --source-image-project-ubuntu-os-cloud --licenses https://www.googleapis.com/compute/v1/projects/fmw-optimz/global/licenses/enable-waa
Created [https://www.googleapis.com/compute/v1/projects/eve-test-276509/global/images/nested-ubuntu-bionic].
NAME: PROJECT: FAMILY: DEPRECATED: STATUS:
nested-ubuntu-bionic eve-test-276509 READY
uidls_dzorkale@cloudshell:~$

```

15.6.2 Creating VM

Step 1: Navigate: Navigation Menu/Compute Engine/VM Instances and press “Create”

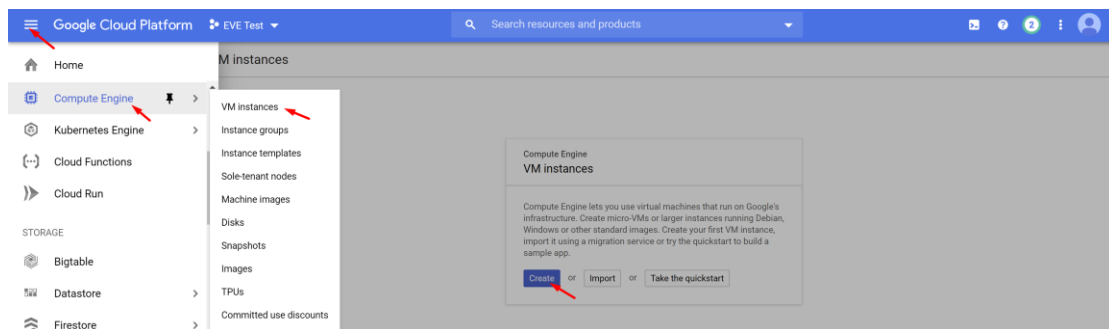

Step 2: Assign the name for your VM

Step 3: Set your own region and zone

Step 4: Edit your Machine Configuration. General-Purpose. Choose the series of CPU platform, Preferred are **Intel CPUs Skylake or Cascade**.

Step 5: Choose your desirable CPU and RAM settings.

IMPORTANT: “Deploy a container image” must be UNCHECKED.

Name [?]
Name is permanent
eve-1

Labels [?] (Optional)
[+ Add label](#)

Region [?] Region is permanent
europe-west2 (London)

Zone [?] Zone is permanent
europe-west2-c

Machine configuration

Machine family
General-purpose | Memory-optimised | Compute-optimised
Machine types for common workloads, optimised for cost and flexibility

Series
N1
Powered by Intel Skylake CPU platform or one of its predecessors

Machine type
n1-standard-16 (16 vCPU, 60 GB memory)

	vCPU	Memory
	16	60 GB

[CPU platform and GPU](#)

Container [?]
 Deploy a container image to this VM instance. [Learn more](#)

Step 6: Select Boot disk. Press Change

Boot disk [?]

 New 10 GB standard persistent disk
Image
Debian GNU/Linux 9 (stretch)

[Change](#)

Step 7. Select Custom images and the **custom boot image you created previously**. Choose HDD disk type and size. HDD size can vary depends of your needs.

Boot disk

Select an image or snapshot to create a boot disk; or attach an existing disk. Can't find what you're looking for? Explore hundreds of VM solutions in [Marketplace](#).

Public images **Custom images** Snapshots Existing disks

Show images from
EVE Test

Show deprecated images

Image
nested-ubuntu-bionic

Created on 22 Jun 2020, 22:50:36

Boot disk type
SSD persistent disk

Size (GB)
60

Step 7: Allow https traffic and create VM

Identity and API access

Service account
Compute Engine default service account

Access scopes

- Allow default access
- Allow full access to all Cloud APIs
- Set access for each API

Firewall

Add tags and firewall rules to allow specific network traffic from the Internet

- Allow HTTP traffic
- Allow HTTPS traffic

Management, security, disks, networking, sole tenancy

Your free trial credit will be used for this VM instance. [GCP Free Tier](#)

Create Cancel

15.6.3 EVE GCP Satellite installation

Step 1: Connect to the VM with the first option "Open in browser window"

Filter VM instances Columns

Name	Zone	Recommendation	In use by	Internal IP	External IP	Connect
<input checked="" type="checkbox"/> eve-1	europa-west2-c			10.154.0.3 (nic0)	35.189.102.127	SSH

Related Actions

- Open in browser window
- Open in browser window on custom port
- Open in browser window using provided private SSH key
- View gcloud command
- Use another SSH client

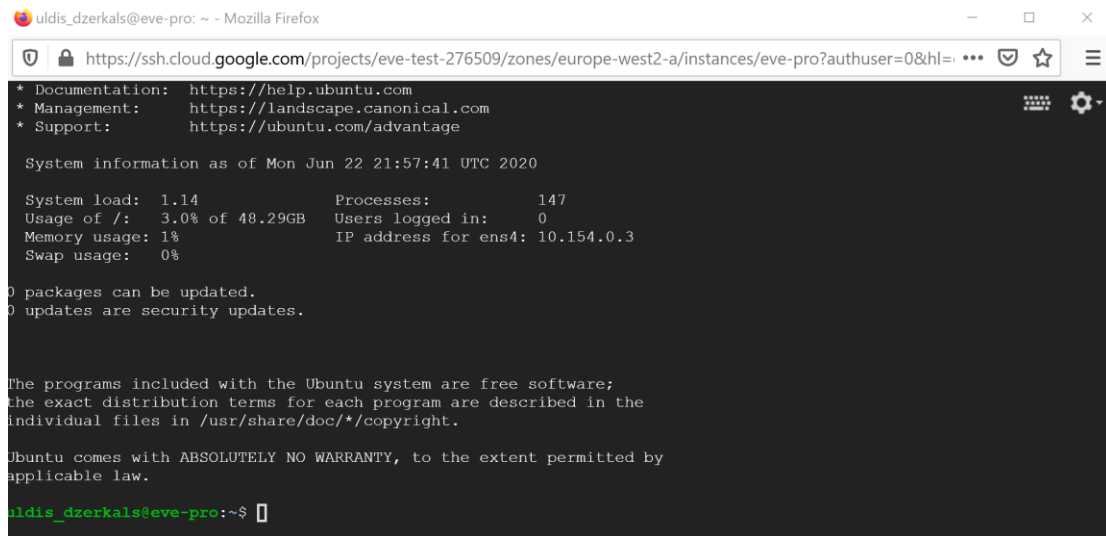

Step 2: Launch installation with:

Type the below command to become root:

```
sudo -i
```

Start EVE-Satellite installation

```
wget -O - https://www.eve-ng.net/focal/install-eve-agent.sh | bash -ii
```

Step 3: Update and upgrade your new EVE-Satellite

```
apt update
```

```
apt upgrade
```

Confirm with Y

Step 4. Reboot EVE. Allow some time for reboot and then press “Reconnect”

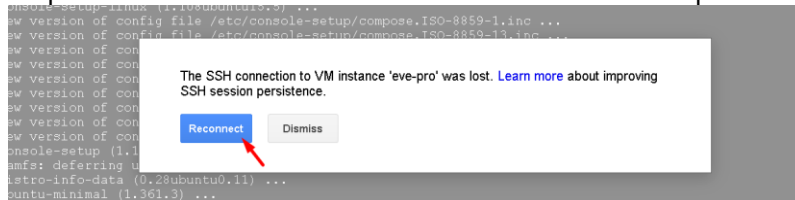

Step 5: **VERY IMPORTANT:** Setup IP

Once the IP wizard screen appears, press **ctrl + c** and type the below command to become root:

```
sudo -i
```

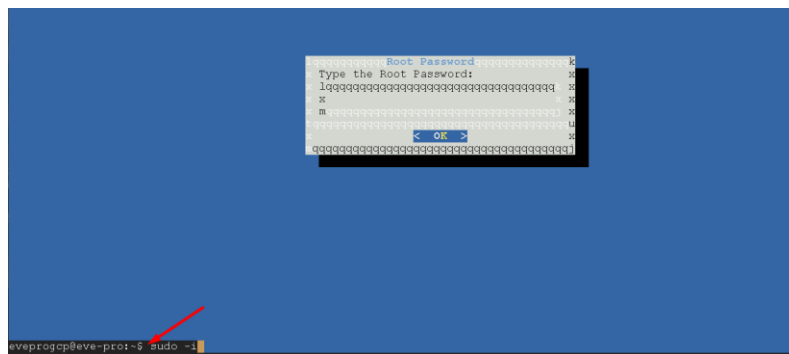

Now follow the IP setup wizard, section: **3.5.2**.

IMPORTANT: set IP as **DHCP!**

Your EVE-Satellite public IP will be used for join satellite to the MASTER node.

Filter VM instances							Columns
<input type="checkbox"/>	Name ^	Zone	Recommendation	In use by	Internal IP	External IP	Connect
<input checked="" type="checkbox"/>	eve-pro	europe-west2-c			10.154.0.2 (nic0)	<u>35.246.119.90</u>	SSH

15.6.4 GCP Firewall rules for Cluster

Step 1: Navigate: Navigation menu/VPC Network/Firewall rules

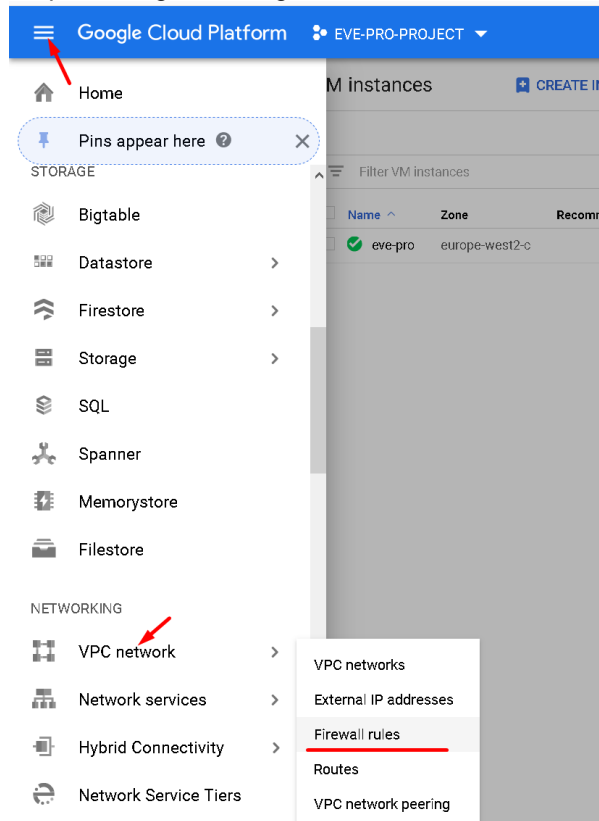

Step 2: Create new firewall rule

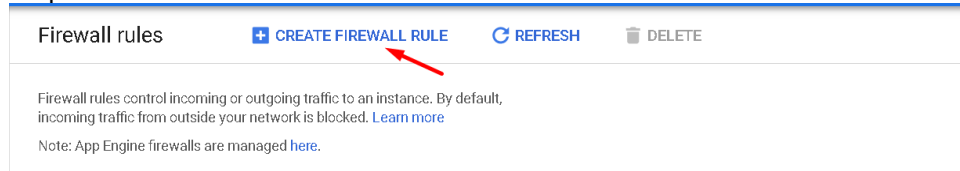

Step 3: Create an ingress and egress FW rules; allow UDP ports all and TCP 22

Name	Type	Targets	Filters	Protocols/ports	Action	Priority	Network	Logs
<input type="checkbox"/> egress-eve	Egress	Apply to all	IP ranges: 0.0.0.0/0	tcp:0-65535	Allow	1000	default	Off
<input checked="" type="checkbox"/> sat-1-rule-egress	Egress	Apply to all	IP ranges: 0.0.0.0/0	udp	Allow	1000	default	Off
<input type="checkbox"/> default-allow-http	Ingress	http-server	IP ranges: 0.0.0.0/0	tcp:80	Allow	1000	default	Off
<input type="checkbox"/> default-allow-https	Ingress	https-server	IP ranges: 0.0.0.0/0	tcp:443	Allow	1000	default	Off
<input type="checkbox"/> ingress-eve	Ingress	Apply to all	IP ranges: 0.0.0.0/0	tcp:0-65535	Allow	1000	default	Off
<input checked="" type="checkbox"/> sat-rule-ingress	Ingress	Apply to all	IP ranges: 0.0.0.0/0	udp	Allow	1000	default	Off
<input type="checkbox"/> default-allow-icmp	Ingress	Apply to all	IP ranges: 0.0.0.0/0	icmp	Allow	65534	default	Off
<input type="checkbox"/> default-allow-internal	Ingress	Apply to all	IP ranges: 10.128.0.0/9	tcp:0-65535 udp:0-65535 icmp	Allow	65534	default	Off
<input type="checkbox"/> default-allow-rdp	Ingress	Apply to all	IP ranges: 0.0.0.0/0	tcp:3389	Allow	65534	default	Off
<input checked="" type="checkbox"/> default-allow-ssh	Ingress	Apply to all	IP ranges: 0.0.0.0/0	tcp:22	Allow	65534	default	Off

15.7 Cluster Management

15.7.1 Join Satellite nodes to the Master

Step 1: Make sure that you have reachability between Master and Satellite nodes and firewall rules are configured in your network if FW is set between them. Firewall rules Section [15.2.1](#)

Step 2: Navigate: System/Cluster Management

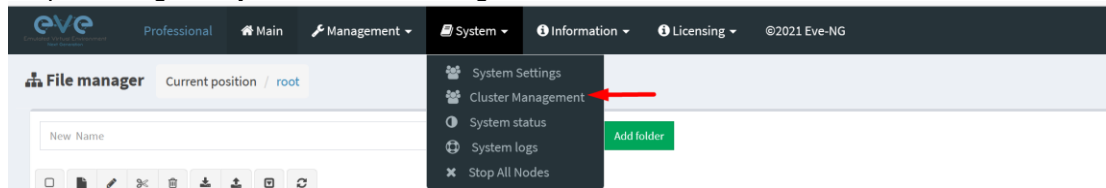

Step 2: Press Add Member

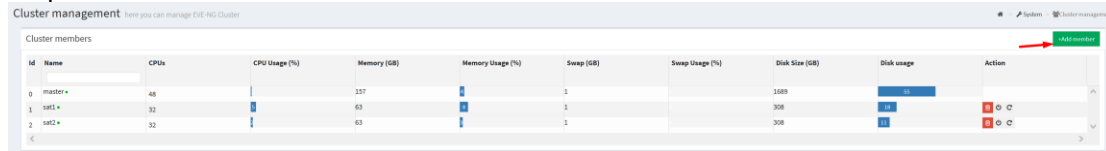

Step 3: Press Add Member and fill your Satellite details:

- Member's Name: use any suitable name for your satellite node
- IP address: Your satellite IP. In GCP version it will be public IP
- Member's Root Password: Your Satellite node password
- Press Add Member

Add New Cluster Member

Member's Name*

IP address

Member's Root Password*

Step 4: After certain of time Satellite will join to the Master

Cluster management here you can manage EVE-NG Cluster

Cluster members										
ID	Name	CPUs	CPU Usage (%)	Memory (GB)	Memory Usage (%)	Swap (GB)	Swap Usage (%)	Disk Size (GB)	Disk usage	Action
0	master	48	<div style="width: 100%;"></div>	157	<div style="width: 100%;"></div>	1		1689	<div style="width: 100%;"></div>	+ ⊖ ⊞ ⊚
1	sat1	32	<div style="width: 100%;"></div>	63	<div style="width: 100%;"></div>	1		308	<div style="width: 100%;"></div>	+ ⊖ ⊞ ⊚
2	sat2	32	<div style="width: 100%;"></div>	63	<div style="width: 100%;"></div>	1		308	<div style="width: 100%;"></div>	+ ⊖ ⊞ ⊚

15.7.2 Remove Satellite nodes from the Master

Step 1: Navigate: System/Cluster Management

Step 2: Press Remove Member

Cluster management here you can manage EVE-NG Cluster

Cluster members										
ID	Name	CPUs	CPU Usage (%)	Memory (GB)	Memory Usage (%)	Swap (GB)	Swap Usage (%)	Disk Size (GB)	Disk usage	Action
0	master	48	<div style="width: 100%;"></div>	157	<div style="width: 100%;"></div>	1		1689	<div style="width: 100%;"></div>	+ ⊖ ⊞ ⊚
1	sat1	32	<div style="width: 100%;"></div>	63	<div style="width: 100%;"></div>	1		308	<div style="width: 100%;"></div>	+ ⊖ ⊞ ⊚
2	sat2	32	<div style="width: 100%;"></div>	63	<div style="width: 100%;"></div>	1		308	<div style="width: 100%;"></div>	+ ⊖ ⊞ ⊚

Remove member

15.7.3 Re-join Satellite nodes from the Master

Step 1: Navigate: System/Cluster Management

Step 2: Press Remove Member

Cluster management here you can manage EVE-NG Cluster

Cluster members										
ID	Name	CPUs	CPU Usage (%)	Memory (GB)	Memory Usage (%)	Swap (GB)	Swap Usage (%)	Disk Size (GB)	Disk usage	Action
0	master	48	<div style="width: 100%;"></div>	157	<div style="width: 100%;"></div>	1		1689	<div style="width: 100%;"></div>	+ ⊖ ⊞ ⊚
1	sat1	32	<div style="width: 100%;"></div>	63	<div style="width: 100%;"></div>	1		308	<div style="width: 100%;"></div>	+ ⊖ ⊞ ⊚
2	sat2	32	<div style="width: 100%;"></div>	63	<div style="width: 100%;"></div>	1		308	<div style="width: 100%;"></div>	+ ⊖ ⊞ ⊚

Remove member

Step 3: Go to Satellite node CLI and reset IP address. It is necessary to refresh SSH key for re-join Satellite to the Master.

CLI:

Login as root to the Satellite node and type:

```
rm -f /etc/wireguard/*
ip link set wg0 down
ip link del wg0

rm -f /opt/ovf/.configured
su -
```

EVE Satellite will initiate IP setup wizard. Follow Section [3.5.1](#)

Step 4: Join Satellite accordingly Section [15.7.1](#)

15.8 Cluster assignment hierarchy

The Cluster Hierarchy depends which of the option is assigned:

Option 1 - User assignment to cluster

Option 2 - Lab assignment

Option 3 - Individual node assignment

	Cluster assignment Options	Description	Conditions
Option 1	EVE WEB GUI Management/User Management/Edit User/Satellite	Admin, Editor or User is forced to use only Cluster Satellite assigned by Admin. User cannot edit Lab or set individual nodes for other cluster Satellites. This Option can be assigned or edited only by Admin	If User account is set to use specific Satellite server, Users can NOT apply Options 2 and 3. This option applies to Admin user as well until Admin user will set his account to use "any"
Option 2	Lab is set to use Specific Cluster Satellite. Select Lab you want Edit/Select Satellite	If Option 1 is set to "any", then Admin or Editor is allowed to set Lab settings globally to use Lab on specific Cluster Satellite	Admin or Editor user accounts Satellite assignment (option 1) must be set to "any"
Option 3	Set lab nodes individually run on specific Cluster server	Admin or Editor can assign single Lab nodes run on specific Cluster Satellite servers	Options 1 and 2 must be set to "any"

Lab User is not allowed to use any of options above

15.8.1 User assignment to the dedicated Satellite (Option 1)

Step 1: Navigate to Management/User Management

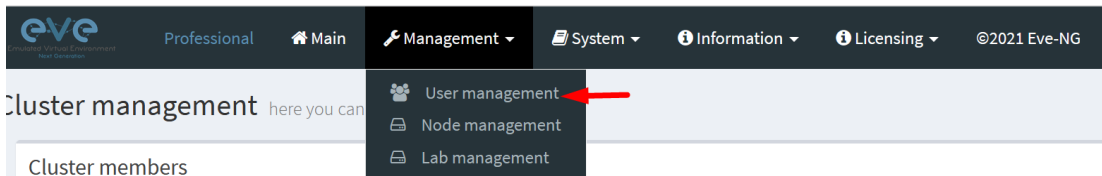

Step 2: Create or Edit existing user

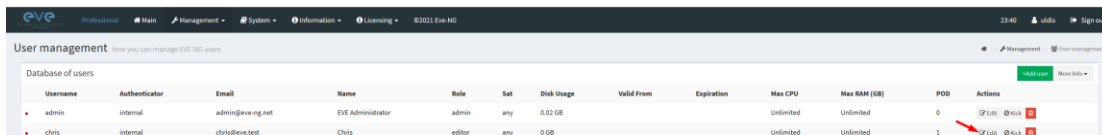

Step 3: Choose the Satellite to be assigned for this user.

Step 4. User will be locked and will use only selected Satellite node. Editor and User roles cannot change or choose other satellite members.

Use only [A-Za-z0-9_-]chars

Role

Satellite 

any

Account

From

to

POD*

15.8.2 Lab assignment to dedicated cluster Satellite (Option 2)

Step 1: Navigate to Lab tree, Select Lab you want assign for dedicated Satellite

Step 2: Click “Edit”

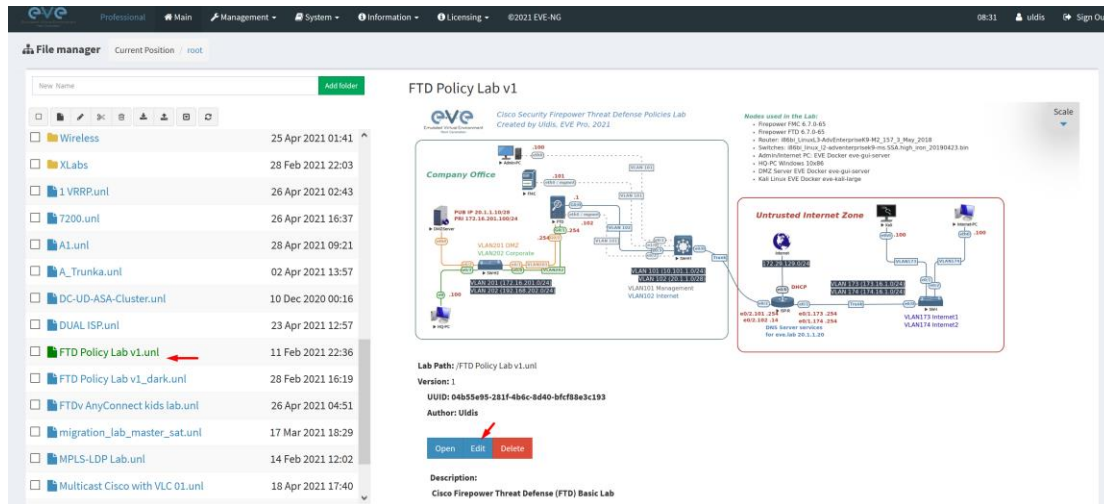

The screenshot shows the EVE-NG File Manager interface. On the left, a file tree lists various lab configurations. The 'FTD Policy Lab v1.unl' file is highlighted with a red arrow. On the right, the details for this lab are displayed, including a network diagram, a list of nodes used in the lab, and buttons for 'Open', 'Edit', and 'Delete'. The 'Edit' button is highlighted with a red arrow.

Step 3: Select Satellite for Lab

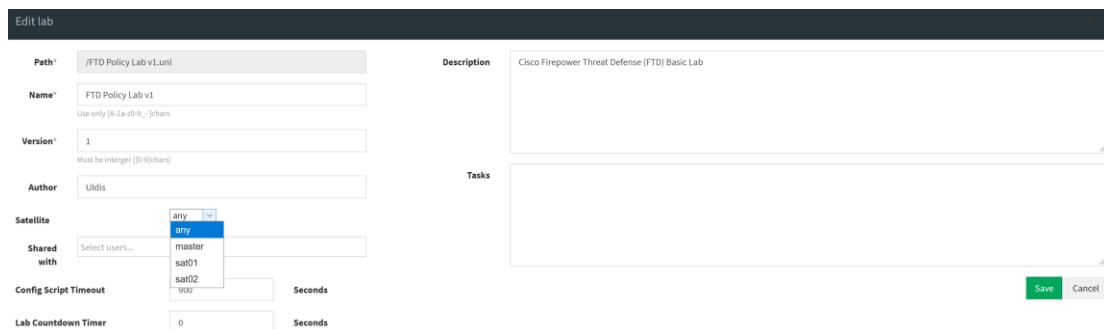

The screenshot shows the 'Edit lab' form in EVE-NG. The form includes fields for Path, Name, Version, Author, Satellite, Shared with, Config Script Timeout, and Lab Countdown Timer. The 'Satellite' dropdown menu is open, showing options: any, master, sat01, and sat02. The 'any' option is selected.

Note: Accordingly, Cluster hierarchy matrix above, this Option will be in force if Option 1 is left to default “any”

15.8.3 Creating EVE labs in Cluster (Option 3)

Step 1: Create new or edit your existing lab

Step 2: On lab Node right click/edit

Step 3: Select preferred Satellite node and click save

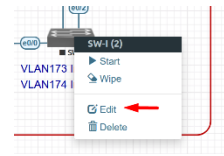

Startup configuration

Default

Delay (s)

0

Left

1434

Satellite

master

- master
- sat1
- sat2
- any

Save
Cancel

Option to assign cluster nodes for single lab devices.

Lab Side bar/Nodes, column SATELLITE, Select your cluster satellites for devices in the lab.

CONFIGURED NODES																	
ID	NAME	SATELLITE	TEMPLATE	ROOT IMAGE	CPU	CPU USAGE	CPU LIMIT	IDLE PC	HYPERVISOR	RAM (MB)	RAM USAGE	ETH	SER	CONSOLE	ICDN	STARTUP-CONFIG	ACTIONS
1	SW-H1	master	isl	IB66_Linux_32-adventerprisek9-ma.SSA	n/a	0%	n/a	n/a	1024	1024	0%	4	0	telnet	Switch L32.png	Default	▶ ⌵ ⌵ ⌵
2	SW4	master	isl	IB66_Linux_32-adventerprisek9-ma.SSA	n/a	0%	n/a	n/a	1024	1024	0%	4	0	telnet	Switch2.png	Default	▶ ⌵ ⌵ ⌵
3	Admin-PC	master	docker	eve-gui-serverlatest	2	0%	n/a	n/a	n/a	4096	0%	1	n/a	rdp	Desktop3.png	Default	▶ ⌵ ⌵ ⌵
4	FTD	master	firepower6	firepower6-FTD-6.7.0-65	4	0%	n/a	n/a	n/a	8192	0%	5	n/a	vnc	ASA2.png	None	▶ ⌵ ⌵ ⌵
5	ISP-R	master	isl	IB66_Linux_32-Adventerprisek9-M2_151	n/a	0%	n/a	n/a	1024	1024	0%	1	0	telnet	Router2.png	Default	▶ ⌵ ⌵ ⌵
6	DMZ-Server	master	docker	eve-gui-serverlatest	1	0%	n/a	n/a	n/a	1024	0%	1	n/a	rdp	Server_WEB1.png	Default	▶ ⌵ ⌵ ⌵
7	HQ-PC	sat1	wln	wln-10-s86-20H2v3	2	0%	n/a	n/a	n/a	4096	0%	1	n/a	rdp-cls	Desktop2.png	None	▶ ⌵ ⌵ ⌵
8	SW-H2	master	isl	IB66_Linux_32-adventerprisek9-ma.SSA	n/a	0%	n/a	n/a	1024	1024	0%	1	0	telnet	Switch2.png	Default	▶ ⌵ ⌵ ⌵
9	FMC	sat2	firepower6	firepower6-FMC-6.7.0-65	4	0%	n/a	n/a	n/a	28672	0%	1	n/a	vnc	FMC.png	None	▶ ⌵ ⌵ ⌵
10	Internet-PC	master	docker	eve-gui-serverlatest	1	0%	n/a	n/a	n/a	1024	0%	1	n/a	rdp	Desktop2.png	Default	▶ ⌵ ⌵ ⌵
11	Kali	sat1	docker	eve-kali-latest	4	0%	n/a	n/a	n/a	8192	0%	1	n/a	rdp	Kali.png	Default	▶ ⌵ ⌵ ⌵

Note: Accordingly, Cluster hierarchy matrix above, this Option will be in force if Options 1 and 2 settings are left default “any”

15.8.4 Master images synchronization with Satellites

Once you have assigned certain lab device to use cluster Satellite node and start it, the automatic rsync process is initiated from Master node copy necessary image to the Satellite cluster member. During rsync process between Master and Satellite lab device will display “Clock” sign beside device. After image rsync process is completed, Lab device will turn sign to “Play”, running state.



Large size lab devices/images, rsync process can take some time. It depends of the network speed between the cluster members.

Once the image is copied into Satellite node, lab device will start immediately. RSYNC process initiates only once if particular device image does not exist on Satellite node.

15.9 Cluster system monitoring

15.9.1 Cluster Monitoring page

Navigate: System/Cluster Management

Information columns displaying live information about cluster members utilization
Satellite nodes have option to reboot or shutdown.

If the cluster is healthy and fully functional, the Status column will display “GREEN” dot beside the cluster members.

id	Name	CPUs	CPU Usage (%)	Memory (GB)	Memory Usage (...)	Swap (GB)	Swap Usage (%)	Disk Size (GB)	Disk usage	Action
0	master	48	<div style="width: 10%;"></div>	157	<div style="width: 10%;"></div>	1		1689	<div style="width: 55%;"></div>	
1	sat1	32	<div style="width: 10%;"></div>	63	<div style="width: 10%;"></div>	1		308	<div style="width: 15%;"></div>	🔄 🛑 🔄
2	sat2	32	<div style="width: 10%;"></div>	63	<div style="width: 10%;"></div>	1		308	<div style="width: 11%;"></div>	🔄 🛑 🔄

If the Satellite node is down or not reachable, the Status column will display “RED” dot

id	Name	CPUs	CPU Usage (%)	Memory (GB)	Memory Usage (...)	Swap (GB)	Swap Usage (%)	Disk Size (GB)	Disk usage	Action
0	master	48	<div style="width: 10%;"></div>	157	<div style="width: 10%;"></div>	1		1689	<div style="width: 55%;"></div>	
1	sat1	32	<div style="width: 10%;"></div>	63	<div style="width: 10%;"></div>	1		308	<div style="width: 15%;"></div>	🔄 🛑 🔄
2	sat2	32	<div style="width: 10%;"></div>	63	<div style="width: 10%;"></div>	1		308	<div style="width: 11%;"></div>	🛑

If the Satellite node is reachable but malfunctioning, Agent service is stopped or crashed, Status will be displayed as Yellow DOT. (stop/reboot possible)

id	Name	CPUs	CPU Usage (%)	Memory (GB)	Memory Usage (%)	Swap (GB)	Swap Usage (%)	Disk Size (GB)	Disk usage	Action
0	master	24	<div style="width: 10%;"></div>	61	<div style="width: 10%;"></div>	4		225	<div style="width: 25%;"></div>	
1	sat1	8	<div style="width: 10%;"></div>	31	<div style="width: 10%;"></div>	1		40	<div style="width: 40%;"></div>	🛑 🔄 🛑
2	sat2	4	<div style="width: 10%;"></div>	20	<div style="width: 10%;"></div>	1		40	<div style="width: 20%;"></div>	🔄 🛑 🔄
3	gcp-sat	8	<div style="width: 10%;"></div>	25	<div style="width: 10%;"></div>	0		40	<div style="width: 10%;"></div>	🛑 🔄 🛑

15.9.2 Satellite disaster recovery

Use case: If a satellite node crashed, was powered off while lab devices were running on it or the connection to the satellite was lost, the Master node will still have these nodes in a running state even if this is no longer the case.

To remediate this situation, you have to purge the local state information about the satellite before recovering the satellite, booting it back up or recovering the connection.

Step 1: To verify status of lab nodes:

Navigate Management/Nodes management. If you observing that crashed Satellite nodes are still alive and visible follow Step 2

Node management here you can manage EVE-NG running nodes

Running node(s)

Labname	Lab ID	Username	Sat	Node Name	CPU usage (%)	RAM usage (%)	Disk usage (GB)	Template	Action
/A_Trunka	1	uldis	master	PC5-2	0	0.03	0.0035	docker	[stop] [delete]
/A_Trunka	1	uldis	master	PC5-1	0	0.02	0.0035	docker	[stop] [delete]
/A_Trunka	1	uldis	master	PC10-2	0	0.02	0.0035	docker	[stop] [delete]
/A_Trunka	1	uldis	master	PC10-1	0	0.02	0.0035	docker	[stop] [delete]
/A_Trunka	1	uldis	sat2	SW2	0.72	0.63	0.0101	viosl2	[stop] [delete]
/A_Trunka	1	uldis	master	PC5-1	0	0.02	0.0031	docker	[stop] [delete]
/A_Trunka	1	uldis	sat2	SW4	0.63	0.58	0.0101	viosl2	[stop] [delete]
/A_Trunka	1	uldis	master	PC10-1	0	0.03	0.0035	docker	[stop] [delete]
/A_Trunka	1	uldis	master	PC5-2	0	0.02	0.0031	docker	[stop] [delete]
/A_Trunka	1	uldis	master	SW3	0.4	0.24	0.0101	viosl2	[stop] [delete]
/A_Trunka	1	uldis	master	SW1	0.38	0.23	0.0101	viosl2	[stop] [delete]
/A_Trunka	1	uldis	sat2	PC10-2	0	0.13	0	docker	[stop] [delete]

Step 2. Navigate: System/Cluster Management
Use **Purge** Button to clean crashed Satellite devices from the Master.

Cluster management here you can manage EVE-NG Cluster

Cluster members

Id	Name	CPUs	CPU Usage (%)	Memory (GB)	Memory Usage (%)	Swap (GB)	Swap Usage (%)	Disk Size (GB)	Disk usage	Action
0	master	48		157		1		1689	95	[stop] [delete] [refresh] [purge]
1	sat1	32		63		1		308	17	[stop] [delete] [refresh] [purge]
2	sat2	32		63		1		308	15	[stop] [delete] [refresh] [purge]

Are you sure you want to remove all running consoles satellite 2?

OK Cancel

15.9.3 EVE Cluster Status

Navigate: System/Cluster Management

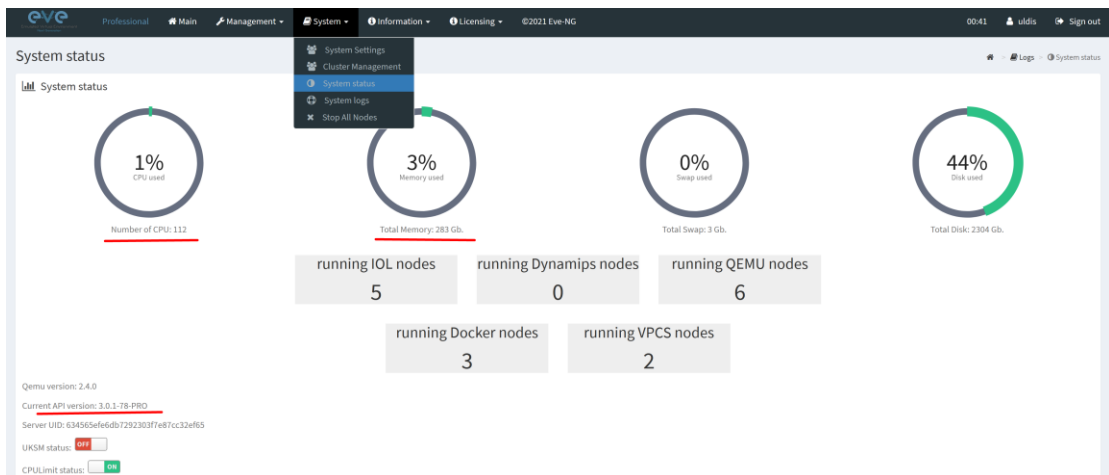

15.9.4 Cluster monitoring cli commands

On EVE Master:
Cluster System CLI Commands:

Check Cluster status:

```
root@eve-ng:~# unl_wrapper -a showcluster
Jan 31 23:56:52 Jan 31 23:56:52 Online Check state: Valid
Cluster Status:
#####
0 master Online ( Local )
1 sat1 Online
2 sat2 Online
#####
root@eve-ng:~#
```

SSH to the Satellite node from the Master status:

```
ssh 172.29.130.<satId>

#####Example SSH to SAT1#####
root@eve-ng:~# ssh 172.29.130.1
Welcome to Ubuntu 18.04.5 LTS (GNU/Linux 4.20.17-eve-ng-uksm-wg+
x86_64)

* Documentation:  https://help.ubuntu.com
* Management:    https://landscape.canonical.com
* Support:       https://ubuntu.com/advantage

* Canonical Livepatch is available for installation.
  - Reduce system reboots and improve kernel security. Activate at:
    https://ubuntu.com/livepatch
Last login: Sun Jan 31 22:24:06 2021 from 10.6.6.14
root
root@eve-sat1:~#
```

Check Cluster Satellite version:

```
root@eve-sat03:~# dpkg -l eve-agent
Desired=Unknown/Install/Remove/Purge/Hold
|   Status=Not/Inst/Conf-files/Unpacked/halF-conf/Half-inst/trig-
aWait/Trig-pend
|/ Err?=(none)/Reinst-required (Status,Err: uppercase=bad)
||/ Name                               Version                               Architecture
Description
+++-----+-----+-----+-----+
=====
ii  eve-agent                             5.0.1-10                             amd64          Agent
for EVE-NG Sat Cluster member
root@eve-sat03:~#
```

15.10 Cluster system upgrade

Pre-requisites: The Master node must reach internet and resolve DNS.

On the EVE Master CLI run commands:

```
apt update
apt upgrade
```

The cluster Satellites will upgrade automatically with EVE master. There no need any extra upgrade run for Satellite nodes.

To update manually Satellite nodes from Master EVE:

```
root@eve-ng:~# unl_wrapper -a updatesat

Feb 01 00:03:24 Feb 01 00:03:24 Online Check state: Valid
Feb 01 00:03:24 update sat 1
ii eve-agent      5.0.1-10      amd64          Agent for EVE-NG Sat
Cluster member
Feb 01 00:03:24 update sat 2
ii eve-agent      5.0.1-10      amd64          Agent for EVE-NG Sat
Cluster member
root@eve-ng:~#
```

16 EVE Troubleshooting

16.1 CLI diagnostic information display commands

16.1.1 Display full EVE Pro diagnostic

```
eve-info
```

16.1.2 Display the currently installed EVE Pro version:

```
dpkg -l eve-ng-pro
```

```
root@eve-ng:~# dpkg -l eve-ng-pro
Desired=Unknown/Install/Remove/Purge/Hold
| Status=Not/Inst/Conf-files/Unpacked/halF-conf/Half-inst/trig-aWait/Trig-pend
|/ Err?=(none)/Reinst-required (Status,Err: uppercase=bad)
||/ Name          Version        Architecture   Description
+++-----+-----+-----+-----+-----+
ii  eve-ng-pro      2.0.4-21      amd64         A new generation software for networking labs.
root@eve-ng:~#
```

16.1.3 Display if EVEs Intel VT-x/EPT option on/off:

```
kvm-ok
```

```
root@eve-ng:~# kvm-ok
INFO: /dev/kvm exists
KVM acceleration can be used
root@eve-ng:~#
```

16.1.4 Display EVEs CPU INFO:

```
lscpu
```

```
root@eve-ng:~# lscpu
Architecture:          x86_64
CPU op-mode(s):        32-bit, 64-bit
Byte Order:             Little Endian
CPU(s):                 24
On-line CPU(s) list:   0-23
Thread(s) per core:    1
Core(s) per socket:    1
Socket(s):              24
NUMA node(s):          4
Vendor ID:              GenuineIntel
CPU family:             6
Model:                  44
Model name:             Intel(R) Xeon(R) CPU           X5680  @ 3.33GHz
Stepping:               2
CPU MHz:                3324.053
BogoMIPS:               6650.00
Virtualization:         VT-x
Hypervisor vendor:     VMware
```

16.1.5 Display EVEs CPU manufacturer:

```
lsmod | grep ^kvm_
```

```
root@eve-ng:~# lsmod | grep ^kvm_
kvm_intel                212992    74
root@eve-ng:~#
```

16.1.6 Display EVEs HDD utilization.

If the /boot only has a little space left you can refer to section **Error! Reference source not found.** If the eve-ng-vg-root reaches 99% or 100% then you will need to expand the HDD in order to continue using EVE. The Solution to expand your HDD is described in section 16.1

```
df -h
```

```
root@eve-ng:~# df -h
Filesystem      Size  Used Avail Use% Mounted on
udev            40G   0    40G   0% /dev
tmpfs           7.9G  52M   7.9G   1% /run
/dev/mapper/eve-ng--vg-root 681G  370G  283G  57% /
tmpfs           40G   0    40G   0% /dev/shm
tmpfs           5.0M   0   5.0M   0% /run/lock
tmpfs           40G   0    40G   0% /sys/fs/cgroup
/dev/sda1       472M   83M  365M  19% /boot
root@eve-ng:~#
```

16.1.7 Display EVEs Bridge interface status

```
brctl show
```

```
root@eve-ng:~# brctl show
bridge name      bridge id      STP enabled    interfaces
docker0          8000.0242c0db8435  no             eth0
nat0             8000.000000000000  no             eth1
pnet0            8000.000c29d0aa94  no             vun11_0_1_0
pnet1            8000.000c29d0aabc  no             eth2
pnet2            8000.000c29d0aa9e  no             eth3
pnet3            8000.000c29d0aaa8  no             eth4
pnet4            8000.000c29d0aab2  no
pnet5            8000.000000000000  no
pnet6            8000.000000000000  no
pnet7            8000.000000000000  no
pnet8            8000.000000000000  no
pnet9            8000.000000000000  no
```

16.1.8 Display EVEs system services status

```
systemctl list-unit-files --state=enabled
```

```
root@eve-ng:~# systemctl list-unit-files --state=enabled
UNIT FILE      STATE
accounts-daemon.service  enabled
autovt@.service  enabled
capdog.service  enabled
cpulimit.service  enabled
cron.service    enabled
docker.service  enabled
getty@.service  enabled
lvm2-monitor.service  enabled
mysql.service   enabled
networking.service  enabled
open-vm-tools.service  enabled
openvswitch-switch.service  enabled
ovfstartup.service  enabled
resolvconf.service  enabled
rsyslog.service  enabled
ssh.service     enabled
sshd.service    enabled
syslog.service  enabled
systemd-timesyncd.service  enabled
unattended-upgrades.service  enabled
ureadahead.service  enabled
dm-event.socket  enabled
docker.socket   enabled
lvm2-lvmetad.socket  enabled
lvm2-lvmpolld.socket  enabled
uuuid.socket    enabled
remote-fs.target  enabled
apt-daily-upgrade.timer  enabled
apt-daily.timer  enabled
```

16.2 Expand EVEs System HDD

⚠ IMPORTANT NOTE: DO NOT expand your current/existing HDD on your EVE VM!

16.2.1 HDD space alert

Important: by default, EVE will trigger alerts if there are 3GB or less HDD space available. Additional nodes will not start until more space is added or freed up. A link is provided in the notification bubble on how to properly add an additional HDD.

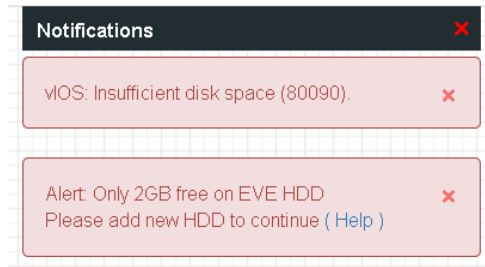

To edit HDD space threshold for the alert is customizable. please follow section: [7.4.1](#)

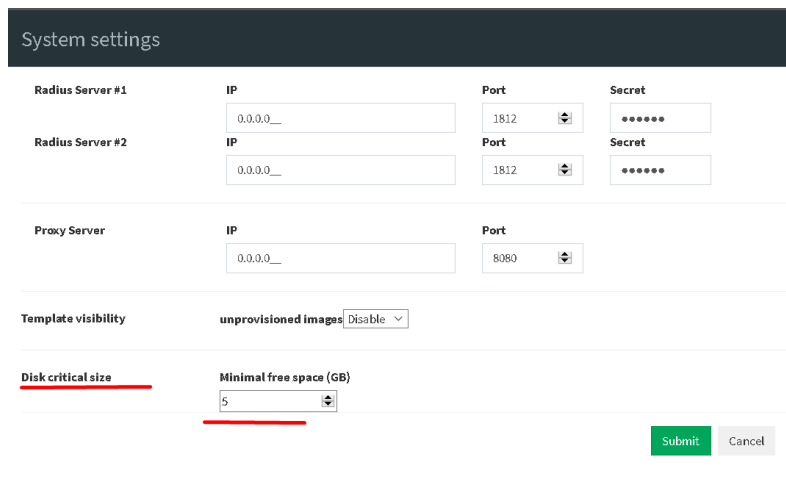

16.2.2 Expand HDD on VMware Workstation

Expanding your EVEs system HDD is achieved by adding an additional HDD to your EVE VM.

Step 1: Stop all your labs and shutdown EVE.

Use EVE CLI command: **shutdown -h now**

Step 2: Go to edit VM settings and add a new Hard drive. Then click Next.

Step 3: Leave the recommended SCSI HDD option and then click Next

Step 4: Make sure you have selected the option “Create a new Virtual disk.”

Step 5: Set your desirable HDD Size; example 200GB.

Step 6: Make sure you have set the option “Store Virtual disk as a single file” and then click Next

Step 7: Optional: Specify the location of where your new HDD will be stored, then click Finish.

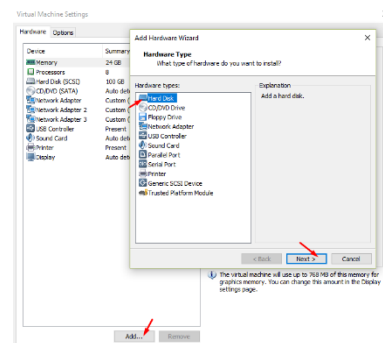

Step 8: Boot your EVE VM, HDD size will be expanded automatically. To verify, use the command to verify HDD utilization referenced in section [16.1.5](#)

16.2.3 Expand your HDD on ESXi

Expanding your EVEs system HDD is achieved by adding an additional HDD to your EVE VM.

Step 1: Stop all your labs and shutdown EVE.

Use EVE CLI command: **shutdown -h now**

Step 2: Go to edit VM settings and add a new Hard drive. Then click Next

Step 3: Make sure you have selected the option “Create a new Virtual disk.” Then click Next

Step 4: Set your desirable HDD Size; example 200GB.

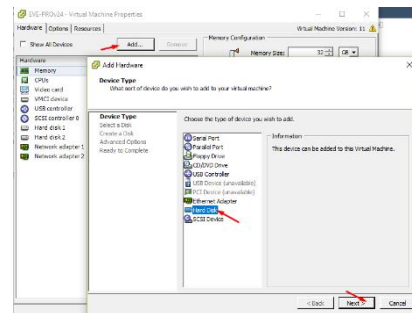

Step 5: It is recommended to set the **Thick Provision Lazy Zeroed** HDD option.

Step 6: Specify the location of where your new HDD will be stored and then click Next

Step 7: Leave the recommended SCSI HDD option as is and click Finish.

Step 8: Boot your EVE VM, the HDD size will be expanded automatically. To verify, use the command to verify HDD utilization referenced in section [16.1.5](#)

16.2.4 Expand your HDD on a Bare Metal EVE Server

It is a complicated process to expand a HDD for a bare metal EVE server. Please open a ticket in our Live chat support for advice.

<https://www.eve-ng.net/index.php/live-helpdesk/>

Use a google account to join in the Live Chat or create new chat account.

16.3 Reset Management IP

Type the following commands into the CLI followed by enter:

```
rm -f /opt/ovf/.configured
```

```
su -
```

<http://www.eve-ng.net/documentation/installation/bare-installIP> address setup wizard. Please follow the steps in section [3.5.1](#) for Static IP or [3.5.2](#) for DHCP IP setup.

16.4 EVE PRO SQL Database recovery

Starting EVE PRO version 3.0.1-21 and later, you can recover SQL user database in case of disaster:

```
unl_wrapper -a restoredb
```

Below is SINGLE LINE Command to restore SQL Database.

```
unl_wrapper -a restoredb ; grep -q default_time_zone /etc/mysql/mysql.conf.d/mysqld.cnf || echo "default_time_zone='+00:00'" >> /etc/mysql/mysql.conf.d/mysqld.cnf ; systemctl restart mysql
```

16.5 EVE PRO Migration from host to host

Step 1: On newly installed EVE navigate to:

```
cd /opt/unetlab/scripts
```

Step 2: Run migration script migrate.sh where source IP is your old EVE host IP and root password of old EVE. [./migrate.sh -s <old eve ip> -p <root password>]

Example:

```
root@eve-ng:/opt/unetlab/scripts# ./migrate.sh -s 192.168.1.100 -p eve
```

Step 3: After migration is completed, deactivate EVE license on old host, and load license in the new EVE machine.

<https://www.eve-ng.net/index.php/documentation/howtos/recover-rehosting-eve-ng/>

16.6 EVE Log files

EVE log Files can be obtained from the System Logs page under the System dropdown menu

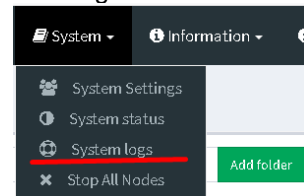

Use the menu to collect log file data you are interested in.

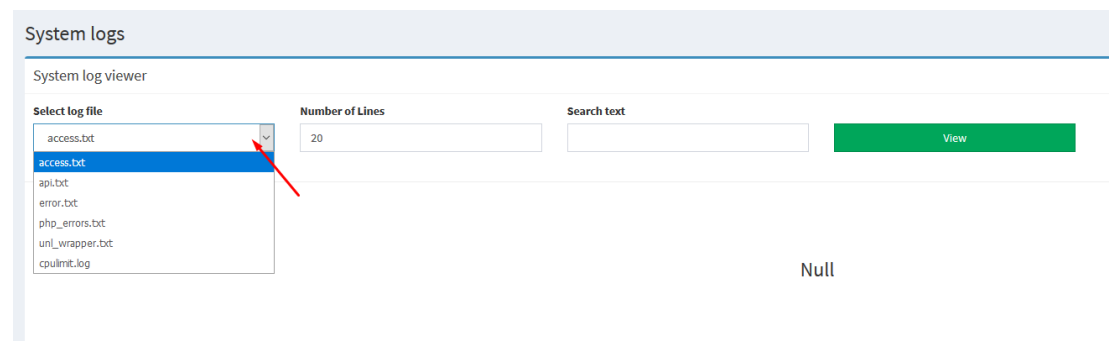

16.7 EVE cli diagnostic info

Use EVE cli to obtain your EVE information:

eve-info

17 EVE Extras

17.1 EVE Pro Radius server setup for user authentication

⚠ Mandatory Prerequisites: Updated EVE-PRO version 2.0.6-30 or later.

Please follow section: **7.4.1**

The screenshot shows the 'System settings' interface for configuring Radius servers. It features two rows, 'Radius Server #1' and 'Radius Server #2'. Each row has four input fields: 'IP' (containing '0.0.0.0'), 'Port' (containing '1812'), and 'Secret' (containing six dots). The 'IP' and 'Port' fields have dropdown arrows on their right sides.

17.1.1 EVE User setup for Radius authentication

Step 1: Open the User management submenu. Management>User management and click Add user

Step 2: The Add New User management window will pop up. Fill in the main information about your EVE user. Make sure that you're the username of the account created in EVE matches with the Radius server database.

Step 3: Enable the External Auth (Radius) checkbox. Any existing password will be removed, because the authenticator will check with the Radius server for credentials.

The screenshot shows the 'Add New User' form. It includes a 'User Name*' field with 'test' entered. Below it is a note: 'Use only [A-Za-z0-9_]chars'. The 'External Auth (Radius)' checkbox is checked, with a red arrow pointing to it. There are also 'Password' and 'Password Confirmation' fields, both containing six dots.

Step 4: If you have purchased licenses for different EVE user roles, you can choose the preferred user role. For licensing and user roles please refer to section **4**

This screenshot shows the 'Role' dropdown menu in the 'Add New User' form. The 'Name' field contains 'John Tester'. The 'Role' dropdown is open, showing 'Administrator' as the selected option, with a red arrow pointing to it. Other options visible are 'Administrator' and 'Editor'. Below the dropdown are 'From' and 'to' date/time fields, with 'From' set to 'User' and 'to' set to '0 -1 0'. The 'POD*' field contains '1'.

Step 5: Set the access date and time From - to. If the fields are left empty (untouched), your user will have no time restrictions for accessing the EVE Server. Account validity with time settings is available for Editor and User roles only.

! Admin accounts have no time limit for account validity, and Account Validity time cannot be set.

Account Validity

From to

POD*

Step 6: The POD number is a value assigned to user accounts automatically. POD numbers are like user profiles inside of EVE and are a unique value for every user Think of PODs like a virtual rack of equipment for each user. Admins can assign a preferred number between 1-128. Please keep POD numbers unique between users!

Step 7: Press ADD 

Step 8. The username created inside EVE must match the username on the Radius server

Example: EVE user authenticated with ISE 2.1 Radius server.

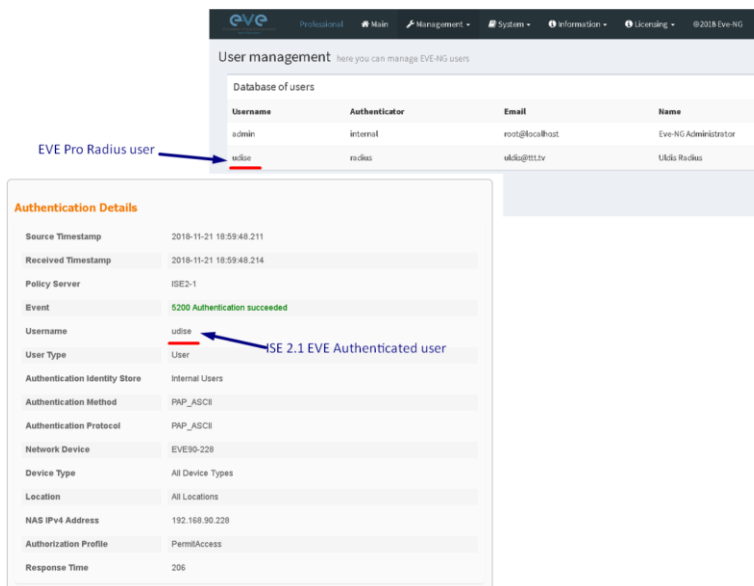

The screenshot shows the 'User management' interface in EVE-NG. A table lists users with columns for Username, Authenticator, Email, and Name. The user 'odise' is highlighted in red, with a blue arrow pointing to it from the text 'EVE Pro Radius user'. Below the table, the 'Authentication Details' for 'odise' are shown. A blue arrow points to the 'Username' field 'odise' with the text 'ISE 2.1 EVE Authenticated user'. The event log shows '5200 Authentication succeeded'.

Username	Authenticator	Email	Name
admin	internal	root@localhost	Eve-NG Administrator
odise	radius	odise@tst.lv	Ukida Radius

Authentication Details

- Source Timestamp: 2018-11-21 18:59:48.211
- Received Timestamp: 2018-11-21 18:59:48.214
- Policy Server: ISE2-1
- Event: 5200 Authentication succeeded
- Username: odise
- User Type: User
- Authentication Identity Store: Internal Users
- Authentication Method: PAP_ASCII
- Authentication Protocol: PAP_ASCII
- Network Device: EVE90-228
- Device Type: All Device Types
- Location: All Locations
- NAS IPv4 Address: 192.168.90.228
- Authorization Profile: PermiAccess
- Response Time: 206

17.2 Active Directory user authentication

! **Mandatory Prerequisites:** Updated EVE-PRO version 2.0.6-30 or later.

To join Active Directory to the EVE, Please follow section: **7.4.1**

The screenshot shows the 'System settings' page. The 'Active Directory Server' section is highlighted with a red box. It contains the following fields:

- Active Directory Server**: IP (192.168.90.27), Port (389), and Enable TLS (checkbox).
- Base DN**: dc=eve,dc=lab
- EVE-NG Active Directory Group**: EVE Users

17.2.1 EVE User setup for AD (LDAP) authentication

Step 1: Open the User management submenu. Management>User management and click Add user

Step 2: The Add New User management window will pop up. Fill in the main information about your EVE user. Make sure that you're the username of the account created in EVE matches with the Radius server database.

Note: The username in of the Active directory user account must match with AD username. Username must have domain at the end of username. Example: **evelabuser@eve.lab**

Step 3: Enable the Active Directory from Authentication menu. Any existing password will be removed, because the authenticator will check with the Active Directory server for credentials.

The screenshot shows the 'Add New User' form. It contains the following fields:

- User Name***: labuser@eve.lab
- Authentication**: active directory (dropdown menu)
- Password**: [Redacted]
- Password Confirmation**: [Redacted]

Step 4: If you have purchased licenses for different EVE user roles, you can choose the preferred user role. For licensing and user roles please refer to section **4**

Step 5: Set the access date and time From - to. If the fields are left empty (untouched), your user will have no time restrictions for accessing the EVE Server. Account validity with time settings is available for Editor and User roles only.

⚠ Admin accounts have no time limit for account validity, and Account Validity time cannot be set.

Step 6: The POD number is a value assigned to user accounts automatically. POD numbers are like user profiles inside of EVE and are a unique value for every user Think of PODs like a virtual rack of equipment for each user. Admins can assign a preferred number between 1-32786. Please keep POD numbers unique between users!

Step 7: Press ADD

Step 8. The username created inside EVE must match the username on the Radius server

17.3 Lab Chat



Refer section: [8.1.12](#)

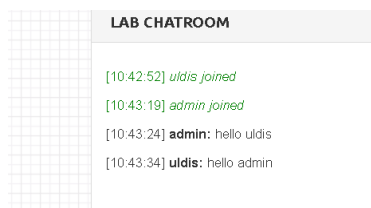

17.4 Custom MAC address for node management

NOTE: Custom first MAC is supported for Qemu nodes only.

Qemu nodes has option to change first interface MAC address.

EDIT NODE

Template: Cisco vIOS

ID: 15

Image: vIOS-adventerprisek9-m.SPA.156-1.T

Name/prefix: vIOS

Icon: Router.png

UUID: 314c922c-9d95-42d3-83c1-187994390538

CPU Limit:

CPU	RAM (MB)	Ethernets
1	1024	4

First Eth MAC Address: aabbcc00dead

QEMU Version: tpl(default 2.4.0) | QEMU Arch: tpl(i386) | QEMU Nic: tpl(e1000)

QEMU custom options: -machine type=pc-1.0,accel=kvm -serial mon:stdio -nographic -nodefconfig -nodef

Startup configuration: None

Delay (s): 0

Console: telnet

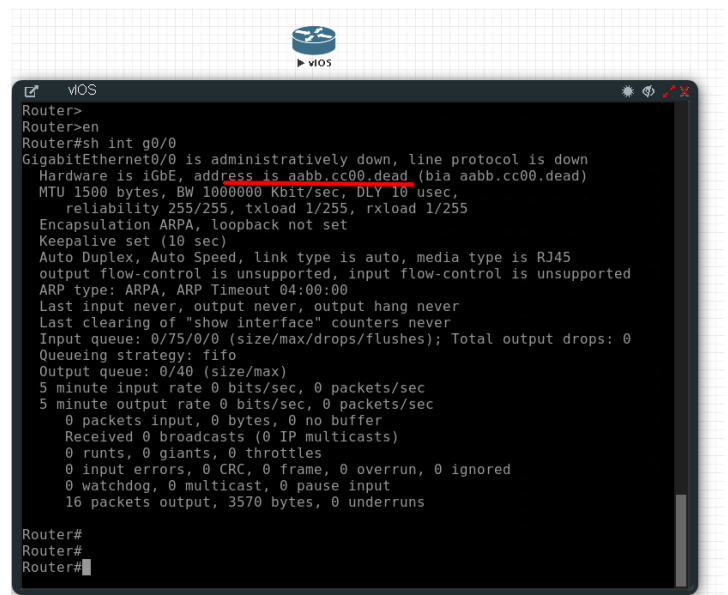

17.5 Windows node settings for Wifi dongle

Using a Wifi USB dongle, you can connect a WiFi-adaptor to windows host inside EVE.

Step 1. Connect your USB Wifi dongle to your EVE server.

Step 2. Issue the following command on the EVE CLI to obtain BUS and host numbers which your USB WiFi is connected to:

```
lsusb
```

```
root@eve-ng:~# lsusb
Bus 002 Device 002: ID 0cf3:9271 Atheros Communications, Inc. AR9271 802.11n
Bus 002 Device 001: ID 1d6b:0002 Linux Foundation 2.0 root hub
Bus 006 Device 001: ID 1d6b:0001 Linux Foundation 1.1 root hub
Bus 005 Device 001: ID 1d6b:0001 Linux Foundation 1.1 root hub
Bus 001 Device 003: ID 0424:2514 Standard Microsystems Corp. USB 2.0 Hub
Bus 001 Device 001: ID 1d6b:0002 Linux Foundation 2.0 root hub
Bus 004 Device 001: ID 1d6b:0001 Linux Foundation 1.1 root hub
Bus 003 Device 002: ID 04e6:5116 SCM Microsystems, Inc. SCR331-LC1 / SCR3310 SmartCard Reader
Bus 003 Device 001: ID 1d6b:0001 Linux Foundation 1.1 root hub
root@eve-ng:~#
```

Step 3. Add the windows node onto the topology and edit the Qemu line:

Change the type value:

type=q35

Add a comma and then the following line:

if=virtio -usb -device usb-host,hostbus=2,hostaddr=2

Where hostbus is your Bus value and hostaddr is your Device ID as seen in the figure above.

Full Windows host qemu line will look like this:

```
-machine type=q35,accel=kvm -cpu  
host,+pcid,+kvm_pv_unhalt,+kvm_pv_eoi,hv_spinlocks=0x1fff,hv_vapic,hv  
_time,hv_reset,hv_vpindex,hv_runtime,hv_relaxed,hv_sync,hv_stimer -  
vga std -usbdevice tablet -boot order=cd -drive  
file=/opt/qemu/share/qemu/virtio-win-  
drivers.img,index=1,if=floppy,readonly,if=virtio -usb -device usb-  
host,hostbus=2,hostaddr=2
```

Template
Windows

ID
6

Image
win-7-x86-IPCC

Name/prefix
Win

Icon
Desktop.png

UUID
eee724a7-53f9-45cb-81b1-c1fec67de630

CPU Limit

CPU	RAM (MB)	Ethernets
1	4096	1

First Eth MAC Address
50:0a:00:06:00:00

QEMU Version	QEMU Arch	QEMU Nic
tpl(2.0.2)	tpl(x86_64)	tpl(e1000)

QEMU custom options (reset to template value)
-machine type=q35,accel=kvm -cpu qemu64,+fsgsbase -vga std -usbdevice tablet

Startup configuration
None

Delay (s)
0

Console
rdp-tls

Left	Top
516	312

18 Images for EVE

Images must be uploaded and prepared before they can be used in labs. The best way to upload images is to use the WinSCP tool for Windows environment or FileZilla for MAC OSX and Linux.

Link to download WinSCP:

<https://winscp.net/eng/download.php>

Link to download FileZilla:

<https://filezilla-project.org/>

To access EVE, use SSH protocol (port 22).

Supported images for EVE are stored in the three locations:

- IOL (IOS on Linux), **/opt/unetlab/addons/iol/bin/**
- Dynamips images, **/opt/unetlab/addons/dynamips**
- Qemu images, **/opt/unetlab/addons/qemu**

18.1 Qemu image naming table

⚠ IMPORTANT NOTE: Intel VT-X/EPT must be enabled to run Qemu nodes in EVE. For information on how to enable this option, Refer to section 3: EVE Installation.

The directory names used for QEMU images are very sensitive and must match the table below exactly in order to work.

Ensure your image folder name starts as per the table. After the "-" you can add whatever you like to label the image. We recommend using the version of your image.

Folder name examples:

`firepower6-FTD-6.2.1`
`acs-5.8.1.4`

The image hdd inside the folder must be named correctly:
Example: `hda.qcow2` or `virtioa.qcow2`

Full path Example: `opt/unetlab/addons/qemu/acs-5.8.1.4/hda.qcow2`
The table of proper folder names is provided in our website:

<https://www.eve-ng.net/index.php/documentation/qemu-image-namings/>

Supported HDD formats and Qemu versions for the EVE images:

HDD Format	HDD name example
<code>lsi([a-z]+).qcow</code>	<code>lsia.qcow</code>
<code>hd([a-z]+).qcow</code>	<code>hda.qcow</code>
<code>virtide([a-z]+).qcow</code>	<code>virtidea.qcow</code>

Supported Qemu Versions
1.3.1
2.0.2
2.2.0
2.4.0
2.5.0
2.6.2
2.12.0
3.1.0
4.1.0

virtio([a-z]+).qcow	virtioa.qcow
scsi([a-z]+).qcow	scsia.qcow
sata([a-z]+).qcow	sataa.qcow

18.2 How to prepare images for EVE

How to add EVE-NG images please refer to:

<https://www.eve-ng.net/index.php/documentation/howtos/>

18.3 How to add custom image template

⚠ IMPORTANT NOTE: Upgrade from EVE version 2.0.5-XX to 2.0.6-XX automatically will convert old config.php to new yml formats: If you had already custom templates in old php format, these templates will be automatically converted to custom_templates.yml file during the upgrade process!

18.3.1 Templates folder choice

⚠ IMPORTANT NOTE: Starting from EVE-PRO Version 2.0.6-42, EVE installation is autodetecting what kind of CPU manufacturer has your server: Intel or AMD, to choose proper templates set. You can check it manually on EVE cli: example below, showing that EVE has Intel CPU.

```
root@eve-ng:~# lsmod | grep ^kvm_
kvm_intel          212992  74
root@eve-ng:~#
```

- If you have Intel CPU, then your template files are in **"/opt/unetlab/html/templates/intel/"**
- If you have AMD CPU, then your template files are in **"/opt/unetlab/html/templates/amd/"**

18.3.2 Prepare template file

⚠ NOTE: For templates development use templates folder which is matching your EVE server CPU.

Example below will be based for Intel CPU EVE custom image template. Use EVE cli or WinSCP/Filezilla to create template.

Step 1: Navigate to EVE location: /opt/unetlab/html/templates/intel/

Step 2: Choose your most suitable template from which you want to make copy and create own image template. (example: newimage.yml)

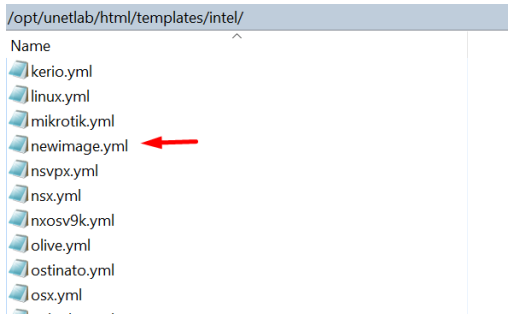

Step 3: Make a copy from source template newimage.yml. Example: Using CLI create template and name it ngips.yml.

```
cp /opt/unetlab/html/templates/intel/newimage.yml /opt/unetlab/html/templates/intel/ngips.yml
```

You can create new template using WinSCP or Filezilla as well.

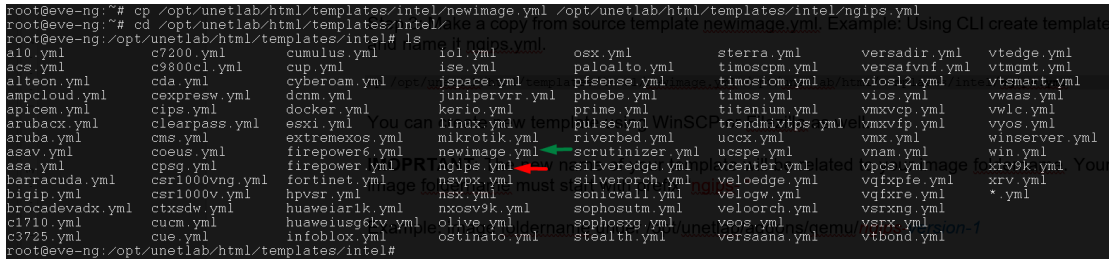

IMPORTANT: The new name of your template will be related to your image foldername. Your image foldername must start with prefix "ngips-"

Example: image foldername under /opt/unetlab/addons/qemu/ngips-6.5.0-115

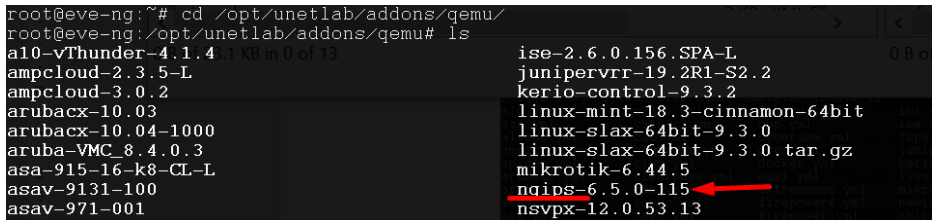

18.3.3 Prepare interface format and name lines

EVE Pro has included option to create various interface names, sequences and numbering. Please refer table below.

Formula	Template line format example	Will produce
eth_format: <prefix>{<first value for slot: example 1>}<separator>{<first value for port>-<number of port per slot: example 8>}	eth_format: Gi{1}/{0-8}	Gi1/0 Gi1/1 Gi1/2 Gi1/3 Gi1/4 Gi1/5 Gi1/6 Gi1/7

		Gi2/0 Gi2/1
eth_format: <prefix>{<first value for slot: example 0>}<separator>{<first value for port>-<number of port per slot: example 4>}	eth_format: Ge{0}/{0-4}	Ge0/0 Ge0/1 Ge0/2 Ge0/3 Ge1/0 Ge1/2 Ge1/3 Ge2/0 Ge2/1 Ge2/2
eth_format: <prefix>{<first value>}	eth_format: Gi{0}	Gi0 Gi1 Gi2 Gi3 ...
eth_format: <prefix>{<first value>}	eth_format: G0/{0}	G0/0 G0/1 G0/2 G0/3 ...
eth_name: <prefix: Interface custom name>	eth_name: - M1 - T1 - T2	M1 T1 T2
eth_name: <prefix: Interface custom name>	eth_name: - MGMT - DATA - TRAFFIC	MGMT DATA TRAFFIC

Combined first named interface following by formatted interfaces Example: We have to set first node interface name “eth0/mgmt” and next following interfaces must start from eth1 and change sequence accordingly. eth1, eth2,.....,ethx

As your node first interface will be custom named (eth0/mgmt), therefore in the template “eth_name:” must be added before “eth_format:”

```
eth_name:
- eth0/mgmt
eth_format: eth{1}
```

This adding will produce Node interfaces.

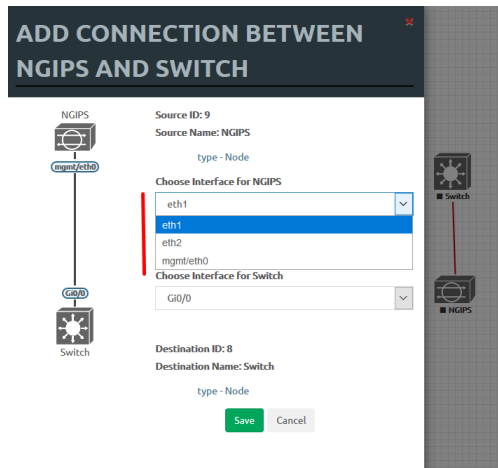

18.3.4 Edit your new template file:

For edit newly created template you can use WinSCP, FileZilla or cli. Example below shows template edit using cli and *nano* editor

```
cd /opt/unetlab/html/templates/intel/
nano ngips.yml
```

Change content, setting for various images can vary depends of vendor requirements. The interface name lines please refer Section: [18.3.2](#)

```
# Copyright (c) 2016, Andrea Dainese
# Copyright (c) 2018, Alain Degreffe
# All rights reserved.
#
# Redistribution and use in source and binary forms, with or without
# modification, are permitted provided that the following conditions are met:
#   * Redistributions of source code must retain the above copyright
#     notice, this list of conditions and the following disclaimer.
#   * Redistributions in binary form must reproduce the above copyright
#     notice, this list of conditions and the following disclaimer in the
#     documentation and/or other materials provided with the distribution.
#   * Neither the name of the UNetLab Ltd nor the name of EVE-NG Ltd nor the
#     names of its contributors may be used to endorse or promote products
#     derived from this software without specific prior written permission.
#
# THIS SOFTWARE IS PROVIDED BY THE COPYRIGHT HOLDERS AND CONTRIBUTORS "AS IS" AND
# ANY EXPRESS OR IMPLIED WARRANTIES, INCLUDING, BUT NOT LIMITED TO, THE IMPLIED
# WARRANTIES OF MERCHANTABILITY AND FITNESS FOR A PARTICULAR PURPOSE ARE
# DISCLAIMED. IN NO EVENT SHALL <COPYRIGHT HOLDER> BE LIABLE FOR ANY
# DIRECT, INDIRECT, INCIDENTAL, SPECIAL, EXEMPLARY, OR CONSEQUENTIAL DAMAGES
# (INCLUDING, BUT NOT LIMITED TO, PROCUREMENT OF SUBSTITUTE GOODS OR SERVICES;
# LOSS OF USE, DATA, OR PROFITS; OR BUSINESS INTERRUPTION) HOWEVER CAUSED AND
# ON ANY THEORY OF LIABILITY, WHETHER IN CONTRACT, STRICT LIABILITY, OR TORT
# (INCLUDING NEGLIGENCE OR OTHERWISE) ARISING IN ANY WAY OUT OF THE USE OF THIS
# SOFTWARE, EVEN IF ADVISED OF THE POSSIBILITY OF SUCH DAMAGE.
---
```

```
type: qemu
name: NGIPS ← Node name on the Topology
description: Cisco FirePower NGIPS ← Node list name
cpulimit: 1
icon: IPS.png
cpu: 4
ram: 8192
ethernet: 3
eth_name:
- eth0/mgmt
eth_format: eth{1}
```





```
console: vnc
shutdown: 1
qemu_arch: x86_64
qemu_version: 2.4.0
qemu_nic: e1000
qemu_options: -machine type=pc,accel=kvm -serial none -nographic -no-user-config
               -nodefaults -display none -vga std -rtc base=utc -cpu host
...
```

Note: Qemu options in the line may vary per image requirements. Please check manufacturer advice how to run KVM image

18.3.5 Prepare new icon for your template:

Step 1 Use Filezilla or Winscp to copy your custom icon IPS.png (icon filename IPS.png used in ngips.yml)

This icon should be about 30-60 x 30-60 in the png format (switch.png is for example 65 x 33, 8-bit/color RGBA)

Step 2 Copy this new icon into /opt/unetlab/html/images/icons/

18.3.6 Template use

Step 1 Create directory /opt/unetlab/addons/qemu/ngips-6.5.0-115

```
mkdir /opt/unetlab/addons/qemu/ngips-6.5.0-115
```

Step 2 Upload image NGIPS, Refer Section: [0](#)

18.4 How to hide unused images in the node list

Please follow section [7.4.1](#) or [8.1.1.1](#)

19 EVE Resources

For additional updated information please follow our web site: <https://www.eve-ng.net>

How to updates: <https://www.eve-ng.net/index.php/documentation/howtos/>

How to videos: <https://www.eve-ng.net/index.php/documentation/howtos-video/>

<https://www.eve-ng.net/index.php/documentation/knox-hutchinson-videos/>

FAQ: <https://www.eve-ng.net/index.php/faq/>

Live support chat: <https://www.eve-ng.net/index.php/live-helpdesk/>

For access to live chat use your Google account or create new chat account.

EVE forum: <https://www.eve-ng.net/forum/>

To access forum resources, please create a new forum account.

EVE YouTube channel:

<https://www.youtube.com/playlist?list=PLF8yvsYkPZQ0myW7aVMZ80k8FU04UUgiV>

EVE Professional downloads: <https://www.eve-ng.net/index.php/download/>

EVE Community version downloads, free: <https://www.eve-ng.net/index.php/community/>

EVE Supported images: <https://www.eve-ng.net/index.php/documentation/supported-images/>