

EVE-NG PE

Professional Edition

Cookbook

Version 7.7

Author:
Uldis Dzerkals

© *EVE-NG LTD*

The information contained in this document is the property of EVE-NG Limited

The contents of the document must not be reproduced or disclosed wholly or in part or used for purposes other than that for which it is supplied without the prior written permission of EVE-NG Limited.

Table of Contents

PREFACE	10
1 INTRODUCTION	11
1.1 WHAT IS EVE-NG?	11
1.2 WHAT IS EVE-NG USED FOR?	11
1.3 WHO IS EVE-NG FOR?	11
2 SYSTEM REQUIREMENTS	12
2.1 HARDWARE REQUIREMENTS	12
2.1.1 <i>Minimal Laptop/PC Desktop system requirements</i>	12
2.1.2 <i>Recommended Laptop/PC Desktop system requirements</i>	13
2.1.3 <i>Virtual Server system requirements</i>	13
2.1.4 <i>Dedicated Server (bare metal BM) system requirements</i>	14
2.1.5 <i>Nodes per lab calculator</i>	14
2.1.6 <i>EVE Management Networks</i>	14
2.2 SUPPORTED VIRTUALIZATION PLATFORMS AND SOFTWARE	15
2.3 UNSUPPORTED HARDWARE AND SYSTEMS	15
3 INSTALLATION	16
3.1 VMWARE WORKSTATION PRO.....	16
3.1.1 <i>VMware Workstation Pro VM installation using ISO image</i>	16
3.1.1.1 EVE VM Setup and Settings	16
3.1.1.2 EVE-NG VM Installation steps	21
3.2 VMWARE ESXi	22
3.2.1 <i>VMware ESXi EVE VM installation using ISO image</i>	22
3.2.1.1 EVE-NG ESXi VM Setup and Settings	23
3.3 PROXMOX VE	26
3.3.1 <i>Proxmox VE EVE VM installation using ISO image</i>	26
3.3.1.1 EVE-NG VM Setup and Settings.....	26
3.4 EVE-NG VM INSTALLATION STEPS	28
3.5 BARE HARDWARE (BM) SERVER INSTALLATION.....	30
3.5.1 <i>BM Server installation EVE ISO</i>	30
3.5.2 <i>BM Server Installation Ubuntu legacy ISO</i>	33
3.6 GOOGLE CLOUD PLATFORM.....	41
3.6.1 <i>Google account</i>	41
3.6.2 <i>Preparing Ubuntu boot disk template</i>	41
3.6.3 <i>Creating VM</i>	42
3.6.4 <i>EVE-NG Pro installation</i>	45
3.6.5 <i>Access to Google Cloud EVE-PRO</i>	47
3.6.6 <i>Optional: GCP MTU 1460 Firewall rules for native console use</i>	47
3.6.7 <i>Optional: Network MTU 1500 settings and firewall rules for GCP</i>	48
3.6.8 <i>Optional: GCP MTU 1500 Firewall rules for native console use</i>	48
3.7 AZURE CLOUD PLATFORM.....	49
3.7.1 <i>Azure account</i>	49
3.7.2 <i>Resource Group</i>	49
3.7.3 <i>Create Virtual machine</i>	50
3.7.4 <i>EVE-NG Software installation</i>	54
3.7.5 <i>Access to Azure Cloud EVE-PRO</i>	56
3.8 EVE MANAGEMENT IP ADDRESS SETUP	56
3.8.1 <i>Static Management IP address setup (preferred)</i>	56
3.8.2 <i>DHCP Management IP address setup</i>	58
3.8.3 <i>Internet proxy setup</i>	59

3.8.4	Reset Management IP settings.....	60
3.9	NATIVE CONSOLE MANAGEMENT SETUP	60
3.9.1	Windows Native Console.....	60
3.9.2	Linux Native Console.....	61
3.9.3	MAC OSX Native Console.....	62
3.10	LOGIN TO THE EVE WEB GUI.....	62
4	EVE-NG PROFESSIONAL LICENSING	63
4.1	EVE-NG PROFESSIONAL BASE LICENSE	63
4.2	EVE-NG LEARNING CENTRE LICENSES	64
4.3	EVE-NG CORPORATE LICENSES.....	66
4.4	USER ROLES COMPARISON CHART.....	67
4.5	LICENSE PURCHASING AND ACTIVATION	68
4.6	LICENSE DEACTIVATION	71
4.7	LICENSE TERM WARNING.....	71
4.8	LICENSE REHOSTING.....	71
5	EVE-NG PROFESSIONAL UPDATE & UPGRADE.....	72
5.1	EVE-NG PROFESSIONAL UPDATE.....	72
5.2	EVE-NG PROFESSIONAL UPGRADE	73
6	TYPES OF EVE MANAGEMENT CONSOLES.....	74
6.1	NATIVE CONSOLE	74
6.1.1	Native Console: telnet.....	74
6.1.2	Native Console: Wireshark	75
6.1.3	Native Console: RDP.....	76
6.2	HTML5 CONSOLE.....	77
6.2.1	HTML5 Console window functions	78
6.2.2	HTML5 Console: Telnet.....	78
6.2.3	HTML5 Console: Wireshark.....	79
6.2.4	HTML5 Console: VNC	80
6.2.5	HTML5 Console: RDP	81
6.3	HTML5 DESKTOP CONSOLE	82
6.3.1	Login to HTML5 Desktop console.....	82
6.3.2	HTML5 Desktop Console: telnet.....	83
6.3.3	HTML5 Desktop Console: Wireshark	84
6.3.4	HTML5 Desktop Console: RDP.....	84
6.3.5	HTML5 Desktop Console: ThinClient Files exchange	85
7	EVE WEB GUI MANAGEMENT	86
7.1	EVE MANAGEMENT PAGE.....	86
7.1.1	Management buttons	86
7.1.2	Right click dropdown menu.....	87
7.1.3	Management tabs	88
7.2	FOLDERS AND LAB FILES MANAGEMENT	89
7.2.1	Folders Management.....	89
7.2.1.1	Default folder Running.....	89
7.2.1.2	Default folder Shared	89
7.2.1.3	Default folder Users	90
7.2.1.4	Create folder	91
7.2.1.5	Delete folder	91
7.2.1.6	Move Folder	92
7.2.1.7	Export Folder.....	92
7.2.1.8	Import Folder	93
7.2.2	Lab files Management.....	93
7.2.2.1	Create Lab	93
7.2.2.2	Delete Lab	94
7.2.2.3	Clone Lab.....	94
7.2.2.4	Move Lab.....	95

7.2.2.5	Export Lab	95
7.2.2.6	Import Labs	96
7.3	EVE MANAGEMENT DROPDOWN MENU	96
7.3.1	<i>EVE User management</i>	96
7.3.1.1	Creating a new EVE User	97
7.3.1.2	Edit EVE User	101
7.3.1.3	User session termination	101
7.3.1.4	User monitoring	102
7.3.1.5	User role assigned lab	102
7.3.2	<i>EVE Node management</i>	103
7.3.2.1	Node management actions	103
7.3.2.2	Node management filtering function	104
7.3.3	<i>EVE Lab management</i>	104
7.3.3.1	Lab management actions	105
7.4	EVE SYSTEM DROPDOWN MENU	106
7.4.1	<i>System Settings</i>	106
7.4.2	<i>Cluster Management</i>	110
7.4.3	<i>System status</i>	110
7.4.4	<i>System logs</i>	111
7.4.5	<i>Stop All Nodes</i>	111
7.5	EVE INFORMATION DROPDOWN MENU	111
7.6	EVE LICENSING DROPDOWN MENU	112
7.7	OTHER TAB LINE INFO	112
7.8	LAB PREVIEW AND GLOBAL SETTINGS	112
7.8.1	<i>Lab preview window</i>	113
7.8.2	<i>Lab preview buttons</i>	113
7.8.3	<i>Lab preview information</i>	113
7.8.4	<i>Lab properties</i>	114
7.9	SIDE BAR FUNCTIONS	115
7.9.1	<i>Add an object</i>	116
7.9.1.1	Node object	116
7.9.1.2	Network object	116
7.9.1.3	Custom shape object	117
7.9.1.4	Text object	117
7.9.1.5	Line object	117
7.9.2	<i>Nodes</i>	117
7.9.3	<i>Networks</i>	118
7.9.4	<i>Startup-configs</i>	119
7.9.5	<i>Configured Objects</i>	120
7.9.6	<i>Traffic Filters</i>	120
7.9.7	<i>More actions</i>	120
7.9.7.1	Start all nodes	121
7.9.7.2	Stop all nodes	121
7.9.7.3	Wipe all nodes	121
7.9.7.4	Console to All Nodes	122
7.9.7.5	Export all CFGs	122
7.9.7.6	Edit lab	122
7.9.7.7	Topology screenshot	123
7.9.7.8	Set node's startup-cfg to default configset	123
7.9.7.9	Set node's startup-cfg to none	123
7.9.7.10	Delete default startup-cfgs	123
7.9.8	<i>Refresh Topology</i>	124
7.9.9	<i>Lab page zoom/unzoom</i>	124
7.9.10	<i>Lab Mini Map</i>	124
7.9.11	<i>Logical Topology</i>	125
7.9.12	<i>Status</i>	125
7.9.13	<i>Lab details</i>	126
7.9.14	<i>Lab Tasks</i>	126
7.9.15	<i>Lab Chat</i>	126
7.9.16	<i>Lock Lab with password</i>	126

7.9.17	Locked Labs Access rules	127
7.9.18	Fullscreen	127
7.9.19	Hide interface labels	127
7.9.20	Dark mode or Light mode	128
7.9.21	Close lab	128
7.9.22	Logout	128
7.10	EVE LAB TOPOLOGY MENUS	128
7.10.1	Lab topology menu	128
7.10.2	Connection menu.....	128
7.10.3	Network Adding.....	129
7.10.4	Bridge or Internal network menu.....	129
7.10.5	Cloud and Private network menu.....	130
7.10.6	Stopped node menu.....	130
7.10.7	Running node menu.....	131
7.10.8	Selected nodes menu and features	133
7.11	EVE LAB NODE STATES AND SYMBOLS	135
7.11.1	Stopped (non-running) nodes	135
7.11.2	Running nodes.....	135
7.11.3	Node connector symbol	136
7.11.4	Node icon resizing	136
7.12	OTHER	137
7.12.1	Notifications area	137
8	WORKING WITH EVE LABS	138
8.1	CREATING A LAB.....	138
8.1.1	Adding nodes to the lab	138
8.1.1.1	Node values Table	140
8.1.2	Edit node.....	142
8.1.2.1	Edit nodes globally	142
8.1.2.2	Edit node individually.....	143
8.1.3	Wipe Node	143
8.1.4	Interconnecting nodes.....	143
8.1.5	Edit connection link style	144
8.1.6	Edit connection link quality	145
8.1.7	Suspend or resume link connection.....	146
8.1.8	Delete connection between nodes.....	147
8.1.9	Delete Node	147
8.2	RUNNING LABS	147
8.2.1	Starting lab.....	147
8.2.2	Interconnecting running nodes (hotlinks).....	148
8.2.3	Link quality delay, packet loss, jitter and rate feature.....	148
8.3	SAVING LABS.....	148
8.4	STOPPING LABS.....	148
8.5	START SAVED LAB.....	149
8.6	WORKING WITH MULTIPLE RUNNING LABS.....	149
8.7	IMPORTING LABS.....	149
8.8	EXPORTING LABS.....	149
8.9	DELETING LABS	149
8.10	MOVING LABS	149
8.11	SHARED PROJECT/LAB.....	149
8.11.1	Create Project Lab share.....	150
8.11.2	Remove Lab share.....	150
8.11.3	Working with shared lab.....	151
8.12	ASSIGNED SINGLE LAB.....	152
9	EVE CLOUDS AND NETWORKS	153
9.1	BRIDGE NETWORK.....	153
9.2	THE SMART BRIDGE FEATURES	153

9.3	INTERNAL NETWORK.....	154
9.4	PRIVATE NETWORK	155
9.5	NAT NETWORK	155
9.6	MANAGEMENT CLOUD0 INTERFACE	156
9.7	REMOVE CLOUD INTERFACES	159
9.8	OTHER CLOUD INTERFACES.....	160
9.9	CONNECTING EXTERNAL VM MACHINES TO THE EVE LAB.....	161
9.9.1	ESXi VM machines	161
9.9.2	VMWare workstation machines	163
9.10	CONNECTING EVE LAB TO A PHYSICAL DEVICE.....	165
9.10.1	ESXi EVE.....	165
9.10.2	VMWare workstation EVE	167
9.10.3	Bare metal server EVE	169
10	ADVANCED EVE LAB FEATURES	170
10.1	LAB DESIGN OBJECTS.....	170
10.1.1	Custom shape	170
10.1.2	Resize square or circle objects	171
10.1.3	Text objects.....	171
10.1.4	Add picture to the topology	172
10.1.5	Custom object linking with telnet or other protocol	172
10.1.6	Line object.....	174
10.1.7	Nodes connection links design	174
10.1.8	Cloning objects and overlay positions	175
10.1.9	Objects Editing Style.....	175
10.1.10	Lock objects movement.....	175
10.2	CUSTOM DESIGN LOGICAL TOPOLOGY	176
10.2.1	Custom design upload	176
10.2.2	Custom topology mapping	177
10.2.3	Delete topology or mapping.....	179
10.3	MULTI-CONFIGURATION SETS EXPORT FEATURE.....	179
10.3.1	Supported nodes for configuration exports.....	180
10.3.2	Startup config management.....	180
10.3.2.1	Global commands	180
10.3.2.2	Individual node commands.....	181
10.3.2.3	Multiple selected nodes commands	181
10.3.2.4	Startup-configuration window.....	181
10.3.2.5	Startup-config window information	182
10.3.3	Export Default configuration set.....	183
10.3.4	Boot nodes from exported Default config set	184
10.3.5	Export new custom config set	185
10.3.6	Edit exported configurations	186
10.3.7	Set lab to boot from config set	187
10.3.8	Set lab to boot from none	187
10.3.9	Delete a config set	188
10.3.10	Rename a config set	188
10.3.11	Export a config set to your local PC	188
10.3.12	Import config set from local PC	189
10.3.13	Export a single nodes config to your local PC	189
10.3.14	Import a single nodes config from your local PC	189
10.3.15	Set lab nodes to boot from different config sets.....	189
10.3.16	Lab config script timeout	190
10.4	LAB TIMER.....	190
10.4.1	Set the Lab Countdown Timer	190
10.4.2	Stop the Lab Countdown Timer	191
10.5	LAB TASKS	191
10.5.1	Creating a new simple task.....	191
10.5.2	Edit a simple task.....	191
10.5.3	Create a task with your PDF workbook	192

10.5.4	Delete a task	193
11	TRAFFIC DETECTION & FILTERING	194
11.1	SET TRAFFIC FILTER	194
11.2	PACP FILTERING SYNTAX	195
11.2.1	PACP GPT Help	195
11.2.2	Filter examples	195
12	WIRESHARK CAPTURE	198
12.1	NATIVE CONSOLE WIRESHARK CAPTURING	198
12.2	HTML5 CONSOLE WIRESHARK CAPTURING	199
12.3	HTML5 DESKTOP CONSOLE WIRESHARK CAPTURING	201
13	THINCLIENT FILE EXCHANGE	204
13.1	THINCLIENT FILES DOWNLOADING	204
13.2	THINCLIENT FILE UPLOAD	205
13.3	OTHER THINCLIENT FILE OPERATIONS	207
14	DOCKERS	210
14.1	EVE INTEGRATED DOCKER STATIONS	210
14.1.1	Docker Machines	210
14.1.2	Docker DHCP IP address setup	212
14.1.3	Docker Static IP and MAC address setup	213
14.1.4	Docker multi-interfaces setup	214
14.1.5	Docker server-gui custom WEB page	214
14.1.6	Docker server-gui SSL WEB page	216
14.1.7	Docker server-gui SSH root access activation	216
14.2	DOCKER CONSOLES	217
14.3	DOCKER CLI ROOT ACCESS	218
14.4	DOCKERS RE-INSTALL/UPDATE	218
14.5	EXTRA DOCKER PACKAGES	218
14.6	THIRD PARTIES DOCKERS	219
14.6.1	Simple docker installation	219
14.6.2	Docker stack installation	220
14.7	VENDOR DOCKERS' INSTALLATION (XRD, VEOS, SR LINUX)	221
14.7.1	Cisco XRd (control plane container)	221
14.7.2	Arista cEOS (Lab)	222
14.7.3	Nokia SR Linux	222
14.8	CUSTOMIZE DOCKER IMAGE WITH YOUR OWN CHANGES.	223
14.9	CUSTOM DOCKER NAME TAGS	224
14.10	DELETE DOCKER IMAGE FROM EVE	225
15	EVE CLUSTER SYSTEM	226
15.1	EVE CLUSTER LICENSING	226
15.2	EVE CLUSTER DESIGN MODELS	226
15.2.1	Bare metal servers cluster	226
15.2.2	ESXi Virtual Machines cluster	227
15.2.3	Hybrid cluster	227
15.2.4	VM Ware workstation light cluster	227
15.2.5	Google Cloud cluster	227
15.3	EVE CLUSTER PRE-REQUISITES	228
15.3.1	Firewall rules between Master and Satellite nodes	228
15.3.2	EVE Cluster interface MTU settings	228
15.3.3	EVE Cluster internal management network	228
15.3.4	EVE Cluster Member's hardware requirements	229
15.3.5	NTP Synchronization requirements	229
15.4	EVE CLUSTER MASTER NODE INSTALLATION	229
15.5	ESXI EVE SATELLITE VM INSTALLATION	229

15.5.1	<i>EVE-NG Satellite ESXi VM Setup and Settings</i>	229
15.6	PROXMOX VE	232
15.6.1	<i>Proxmox VE EVE VM installation using ISO image</i>	232
15.6.1.1	EVE-NG VM Setup and Settings	232
15.6.1.2	EVE-NG Satellite VM Installation steps	234
15.7	BARE HARDWARE (BM) SERVER EVE SATELLITE INSTALLATION	236
15.7.1	<i>BM Satellite server installation EVE PRO Full ISO</i>	236
15.7.2	<i>BM Satellite installation Ubuntu legacy ISO</i>	239
15.8	GOOGLE CLOUD EVE SATELLITE INSTALLATION	240
15.8.1	<i>Google account</i>	240
15.8.2	<i>Preparing Ubuntu boot disk template</i>	240
15.8.3	<i>Network MTU 1500 settings and firewall rules for GCP</i>	241
15.8.4	<i>Optional: GCP MTU 1500 Firewall rules for native console use</i>	242
15.8.5	<i>Creating VM</i>	242
15.8.6	<i>EVE-NG Satellite installation</i>	245
15.8.7	<i>GCP Firewall rules for Cluster</i>	246
15.9	CLUSTER MANAGEMENT.....	247
15.9.1	<i>Join Satellite nodes to the Master</i>	247
15.9.2	<i>Remove Satellite nodes from the Master</i>	248
15.9.3	<i>Re-join Satellite nodes from the Master</i>	248
15.9.4	<i>Change Satellite IP address</i>	249
15.10	CLUSTER ASSIGNMENT HIERARCHY	249
15.10.1	<i>Single Satellite server assignment</i>	249
15.10.1.1	User assignment to the dedicated Satellite (Option 1)	249
15.10.1.2	Lab assignment to dedicated cluster Satellite (Option 2)	250
15.10.1.3	Creating EVE labs in Cluster (Option 3).....	251
15.10.2	<i>Multi Satellite servers' assignment</i>	252
15.10.2.1	Multi Satellites user Profiles	252
15.10.2.2	User assignment to the dedicated Satellites	252
15.10.3	<i>Master images synchronization with Satellites</i>	254
15.11	CLUSTER SYSTEM MONITORING	255
15.11.1	<i>Cluster Monitoring page</i>	255
15.11.2	<i>Satellite disaster recovery</i>	255
15.11.3	<i>EVE Cluster Status</i>	256
15.11.4	<i>Cluster monitoring cli commands</i>	256
15.12	CLUSTER SYSTEM UPGRADE	257
16	EVE TROUBLESHOOTING	259
16.1	CLI DIAGNOSTIC INFORMATION DISPLAY COMMANDS	259
16.1.1	<i>Display full EVE Pro diagnostic</i>	259
16.1.2	<i>Display the currently installed EVE Pro version:</i>	259
16.1.3	<i>Display if EVEs Intel VT-x/EPT option on/off:</i>	259
16.1.4	<i>Display EVEs CPU INFO:</i>	259
16.1.5	<i>Display EVEs CPU manufacturer:</i>	259
16.1.6	<i>Display EVEs HDD utilization.</i>	260
16.1.7	<i>Display EVEs Bridge interface status</i>	260
16.1.8	<i>Display EVEs system services status</i>	260
16.2	CORRECT EVE SERVER NETWORK INTERFACES ORDER	260
16.3	EXPAND EVEs SYSTEM HDD.....	261
16.3.1	<i>HDD space alert</i>	261
16.3.2	<i>Expand HDD on VMware Workstation</i>	261
16.3.3	<i>Expand your HDD on ESXi</i>	262
16.3.4	<i>Expand your HDD on a Bare Metal EVE Server</i>	262
16.4	RESET MANAGEMENT IP	263
16.5	EVE PRO SQL DATABASE RECOVERY	263
16.6	EVE PRO MIGRATION FROM HOST TO HOST	263
16.7	EVE LOG FILES	263
16.8	EVE CLI DIAGNOSTIC INFO.....	263

17	EVE EXTRAS	265
17.1	EVE PRO LOGIN PAGE CUSTOMIZATION	265
17.2	EVE PRO RADIUS SERVER SETUP FOR USER AUTHENTICATION	266
17.2.1	<i>EVE User setup for Radius authentication</i>	<i>266</i>
17.3	ACTIVE DIRECTORY USER AUTHENTICATION	268
17.3.1	<i>EVE User setup for AD (LDAP) authentication.....</i>	<i>268</i>
17.4	LAB CHAT.....	270
17.5	CUSTOM MAC ADDRESS FOR NODE MANAGEMENT	270
17.6	WINDOWS NODE SETTINGS FOR WIFI DONGLE	270
17.7	MASTER SERVER NIC PORTS ORDER CHANGE.....	271
17.8	SATELLITE SERVER NIC PORTS ORDER CHANGE	272
18	IMAGES FOR EVE.....	274
18.1	QEMU IMAGE NAMING TABLE	274
18.2	HOW TO PREPARE IMAGES FOR EVE.....	275
18.3	HOW TO ADD CUSTOM IMAGE TEMPLATE.....	275
18.3.1	<i>Templates folder choice.....</i>	<i>275</i>
18.3.2	<i>Prepare template file.....</i>	<i>275</i>
18.3.3	<i>Prepare interface format and name lines.....</i>	<i>276</i>
18.3.4	<i>Edit your new template file:.....</i>	<i>278</i>
18.3.5	<i>Prepare new icon for your template:.....</i>	<i>279</i>
18.3.6	<i>Template use</i>	<i>279</i>
18.4	HOW TO HIDE UNUSED IMAGES IN THE NODE LIST	279
19	EVE BACKUP SOLUTION.....	280
19.1	BACKUP MANAGER.....	280
19.1.1	<i>Backup Manager Installation</i>	<i>280</i>
19.1.2	<i>Setup external SFTP or FTP server</i>	<i>280</i>
19.1.3	<i>Backup Manager SFTP/FTP settings</i>	<i>280</i>
19.2	CREATE AN EVE-NG BACKUP.....	281
19.2.1	<i>Backup option All</i>	<i>281</i>
19.2.2	<i>Backup option custom selected</i>	<i>282</i>
19.2.3	<i>Backup option with Mirroring selected</i>	<i>282</i>
19.3	RESTORE DATA FROM EVE-NG BACKUP	283
19.3.1	<i>Select restore backup folder</i>	<i>283</i>
19.3.2	<i>Select the items to restore</i>	<i>284</i>
19.4	EVE-NG BACKUP SESSION TERMINATION	284
20	EVE RESOURCES.....	285

Preface

When I first heard about EVE-NG I was skeptical. Back then I used to Lab mainly with ESX by deploying many virtual Devices and connecting them manually by separate vSwitches for Point-to-Point connections. The Problem with that was, that it was extremely time-consuming and did not scale - for every new Device I had to create multiple vSwitches to interconnect them with the virtual Machines - a Nightmare. I was in the middle of my JNCIE-Exam-Prep when I first saw EVE-NG on Twitter - I downloaded the Community Edition, which was the only Edition back then and I was amazed how easy Labbing all of a sudden was. No more deploying of vSwitches to interconnect nodes and boy did it Scale...

If you follow me on Twitter you know, that I'm one of the hardest Juniper Fanboys and of course my Goal was to "Juniperize" EVE. I started to get in touch with UD and Alain and found myself into the Position as one of the Juniper Test Guys. Meanwhile I added nearly all Juniper related Devices (including vSRX and JATP) and I still test a Lot - but now on EVE-Pro.

The Pro-Edition was a big step forward for the Project. It added some nice Features like "hot-add-interconnect" and the Ability to use EVE-NG with multiple Users. Especially Companies will love EVE as it is THE Solution for Labs and PoC's. I have successfully run over 30 PoC's in EVE and over 100 Labs (Job-Related and Personal Labs) - and I still enjoy it every day thanks to EVE and the amazing Team behind it. When the Guys asked me to write the Introduction, I was of course honored and now this Book is finally coming out to help you on your Quest to Setup, Run and Manage EVE-NG in a lot of possible ways.

Well - enough from my Side. I hope you enjoy this Cookbook and use it wisely for your Everyday EVE Work. If you have Problems there is always the EVE-Forum and Live-Helpdesk - you will also find me there from time to time ;)

I wish you happy reading and if you think, that this Product is amazing feel free to support it by buying the PRO-Edition or Donating a bit – it helps to expand this already cool Product even more and it also honors all the work that the Guys spent in it.

Christian Scholz
@chsjuniper

1 Introduction

1.1 What is EVE-NG?

To describe what **E**mulated **V**irtual **E**nvironment – **N**ext **G**eneration (**EVE-NG**) is without solely stating dry facts about features, we need to elaborate more on what EVE-NG can be used for and whom it would be useful for.

In some trivial dry words, EVE-NG gives you tools to use around virtual devices and interconnect them with other virtual or physical devices. Many of its features greatly simplify the usability, re-usability, manageability, interconnectivity, distribution and therefore the ability to understand and share topologies, work, ideas, concepts or simply “labs”. This can simply mean it will reduce the cost and time to set up what you need or it might enable you to do tasks you would not have thought could be done this simple.

1.2 What is EVE-NG used for?

This is the real question but there is no finite answer, the possibilities are almost limitless and depends on what you want to use it for.

It can be used for studying all kinds of technologies. You can learn about general technologies or vendor specific topics. You can test new technologies like network automation, SDN, etc.

It can be used to recreate corporate networks and test changes before putting them into production. You can create proof of concepts for clients. You can troubleshoot network issues by recreating them and e.g. use Wireshark to inspect packets.

It is most definitely not just for networking, it can be used to test software in simulated networks, test out security vulnerabilities of any kind, system engineering like LDAP and AD servers and many more areas.

You could set it up to automate sandboxing unknown files/software and use software to analyse short- and long-term behaviour for malicious intent much simpler than without EVE-NG.

The list of what EVE-NG can be used for could go on indefinitely, possibilities are limited by knowledge and imagination only. Both of which can be improved with EVE-NG.

To get a very small idea of what can be done with EVE-NG, check out the tested/[supported images](#) (many have not been tested, almost everything virtual should run on EVE-NG) and refer to section **18**.

EVE-NG helps you achieve what you want to and more.

1.3 Who is EVE-NG for?

EVE-NG is for everyone working in the Information Technology Sector, period.

It is for very large enterprise companies, training facilities, service providers, consultants, people who want to train themselves; it is for everyone, it is for YOU!

Use-cases that are more than worth it, almost priceless even, can be found everywhere.

The EVE-NG community version is free for everyone; while the paid professional version adds a few things that make your life easier. Almost everything can still be done with the free version, just less conveniently and therefore more time-consuming.

However, with the free version, the possibility to train yourself with technologies, hone your skills and become an expert even with very no monetary possibilities. For some this is and has been life changing.

2 System requirements

EVE-NG software is available in the ISO file format. The ISO is an open standard for packaging and distributing install media. It can be used to deploy a VM in hypervisors like VMware Workstation, Player and ESXi. Please note that installing EVE as a Virtual Machine (VM) will mean any nodes deployed within EVE will be nested. Nested virtualization causes degraded performance in deployed nodes. This should be fine for lab purposes as long as the host meets or exceeds the resource requirements for the deployed nodes.

EVE-NG can also be installed directly on physical hardware, without a hypervisor, using the provided ISO image. This is referred to as a “bare metal” install and is the most recommended method of installing EVE-NG.

2.1 Hardware requirements

⚠ NOTE: It is myth when people are saying: I have 128GB RAM and it is good server and can run a lot. It is not true.

The EVE-NG hardware priorities are:

1. CPU, and as more CPU cores you have assigned for EVE server as better.
2. Fast HDD drive like SSD, No external drives
3. and only then is RAM

If you have 4 CPU assigned for EVE server and it also has 64GB RAM, your RAM becomes useless, because, your VM CPU cannot hold the labs!

2.1.1 Minimal Laptop/PC Desktop system requirements

Prerequisites:

CPU: Intel CPU supporting Intel® VT-x /EPT virtualization
Operating System: Windows 10, 11 or Linux Desktop
VMware Workstation Pro 16.0 or later

PC/Laptop HW requirements	
CPU	Intel i7 (8 Logical processors vCPU), Enabled Intel virtualization in BIOS
RAM	16Gb
HDD Space	500Gb or more
Network	LAN/WLAN
EVE Virtual machine requirements	
CPU	1/8 (Amount of processors/Number of cores per processor) Enabled Virtualize Intel VT-x/EPT or AMD-V/RVI and virtualize IOMMU options
RAM	16Gb or more
HDD	120Gb or more
Network	VMware NAT or Bridged network adapter

Note: Minimal/small PC Desktop/Laptop will be able to run small Labs. The performance and quantity of nodes per lab depend on the types of nodes deployed in the lab.

Example:

IOL image-based nodes: up to 30- nodes per lab
 Dynamips image-based nodes: up to 20-25 nodes per lab
 vIOS image-based nodes: up to 8-10 nodes per lab
 CSRv1000 or XRv image-based nodes: up to 2-3 per lab

2.1.2 Recommended Laptop/PC Desktop system requirements

Prerequisites:

CPU: Intel CPU supporting Intel® VT-x /EPT virtualization
 Operation System: Windows 10, 11 or Linux Desktop
 VMware Workstation Pro 16.0 or later

PC/Laptop HW requirements	
CPU	Intel i7 (16 Logical processors), Enabled Intel virtualization in BIOS
RAM	32Gb
HDD Space	500Gb or more
Network	LAN/WLAN
EVE Virtual machine requirements	
CPU	1/16 (Amount of processors/Number of cores per processor) Enabled Virtualize Intel VT-x/EPT or AMD-V/RVI and virtualize IOMMU options
RAM	32Gb or more
HDD	300Gb or more
Network	VMware NAT or Bridged network adapter

Note: PC Desktops/Laptops will be able to run small to medium Labs. Performance and quantity of nodes per lab depend on the type of nodes deployed in the lab.

Example:

IOL image-based nodes: up to 120 nodes per lab
 vIOS image-based nodes: up to 20-40 nodes per lab
 CSR image-based nodes: up to 10 per lab

2.1.3 Virtual Server system requirements

Prerequisites:

CPU: Intel Xeon CPU supporting Intel® VT-x with Extended Page Tables (EPT)
 Operation System: VM Ware ESXi 6.7 or later, Proxmox VM 8.x or later

Server HW requirements	
CPU	Recommended CPU 2x Intel Xeon (48 Logical processors) or better supporting Intel® VT-x with Extended Page Tables (EPT) Minimum CPU is any Intel Xeon CPU supporting Intel® VT-x with Extended Page Tables (EPT) or better
RAM	128Gb
HDD Space	2Tb
Network	LAN Ethernet

EVE Virtual machine requirements	
CPU	2/24 (48) (Number of processors/Cores per socket) Set Expose hardware assisted virtualization to the guest OS to ON (checked) and set Expose IOMMU to the guest OS to ON (checked)
RAM	64Gb or more
HDD	800Gb or more
Network	vSwitch/VMnet

Note: Performance and quantity of nodes per lab depends from the type of nodes used in the lab.

Example:

120 IOL image-based lab

20 CSRV1000 image-based nodes per lab

2.1.4 Dedicated Server (bare metal BM) system requirements

Prerequisites:

CPU: Intel Xeon CPU supporting Intel® VT-x with Extended Page Tables (EPT)

Operation System: Ubuntu Server 24.04 LTS x64

Server HW requirements	
CPU	Recommended CPU Intel Xeon (48 Logical processors) or better supporting Intel® VT-x with Extended Page Tables (EPT) Minimum CPU is any Intel Xeon CPU supporting Intel® VT-x with Extended Page Tables (EPT)
RAM	128Gb
HDD Space	2Tb
Network	LAN Ethernet

Note: Performance and quantity of nodes per lab depends from type of nodes used in the lab.

2.1.5 Nodes per lab calculator

It is recommended to use the “nodes per lab calculator” to achieve best performance and avoid overloading your EVE system.

<https://www.eve-ng.net/index.php/download/#CALC>

2.1.6 EVE Management Networks

NOTE: Please make sure if these subnets are NOT used in your network outside of EVE.

172.29.129.0/24 (NAT Interface)

172.29.130.0/24 (Cluster VPN subnet, wg0 interface)

172.17.0.0/16 (Dockers consoles)

To change these networks please refer chapter **7.4.1**

2.2 Supported virtualization platforms and software

- VMware Workstation Pro 16.0 or later
- VMware ESXi 6.7 or later
- Ubuntu Server 24.04 LTS as platform for bare metal
- Google Cloud Platform
- AMD CPU based PC or Server (5950x, 7950x, 9950x, etc series)

2.3 Unsupported hardware and systems

The following are currently not supported officially:

- Oracle VirtualBox virtualization
- Citrix XenServer
- Microsoft HyperV
- MAC OSX M Series CPU
- External HDD, like OneDrive, USB external HDD, DAS, NAS or SAN.
- AWS Cloud VM
- VM Ware NAS or DAS HDD system
- Wireless NIC for Bare server EVE installation

3 Installation

3.1 VMware Workstation Pro

3.1.1 VMware Workstation Pro VM installation using ISO image

Download EVE-NG Professional Full ISO distribution image:

<https://www.eve-ng.net/index.php/download/>

3.1.1.1 EVE VM Setup and Settings

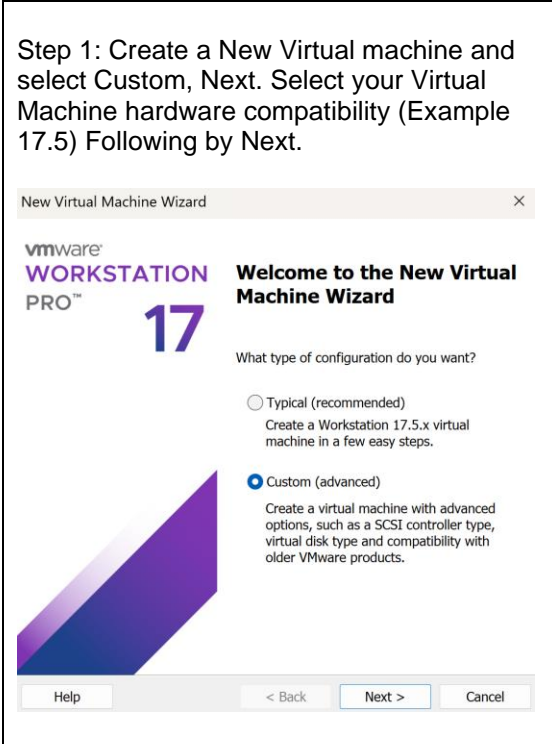
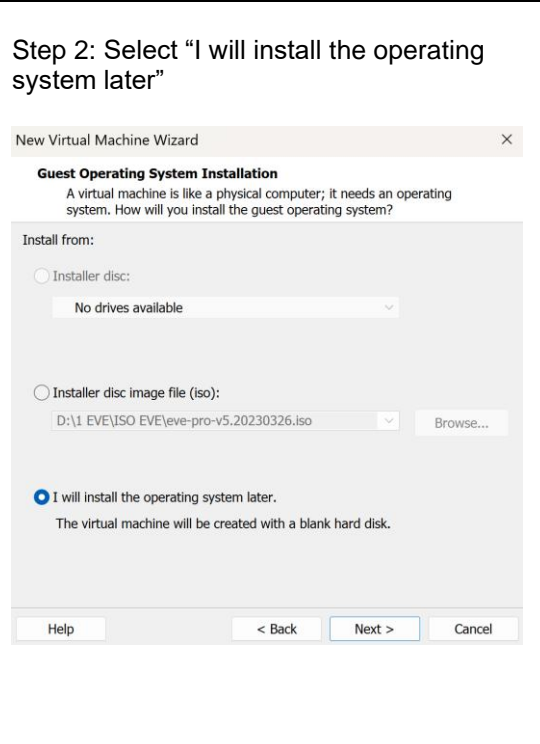
<p>Step 1: Create a New Virtual machine and select Custom, Next. Select your Virtual Machine hardware compatibility (Example 17.5) Following by Next.</p>  <p>New Virtual Machine Wizard</p> <p>vmware WORKSTATION PRO™ 17</p> <p>Welcome to the New Virtual Machine Wizard</p> <p>What type of configuration do you want?</p> <p><input type="radio"/> Typical (recommended) Create a Workstation 17.5.x virtual machine in a few easy steps.</p> <p><input checked="" type="radio"/> Custom (advanced) Create a virtual machine with advanced options, such as a SCSI controller type, virtual disk type and compatibility with older VMware products.</p> <p>Help < Back Next > Cancel</p>	<p>Step 2: Select "I will install the operating system later"</p>  <p>New Virtual Machine Wizard</p> <p>Guest Operating System Installation A virtual machine is like a physical computer; it needs an operating system. How will you install the guest operating system?</p> <p>Install from:</p> <p><input type="radio"/> Installer disc: No drives available</p> <p><input type="radio"/> Installer disc image file (iso): D:\1 EVE\ISO EVE\eve-pro-v5.20230326.iso Browse...</p> <p><input checked="" type="radio"/> I will install the operating system later. The virtual machine will be created with a blank hard disk.</p> <p>Help < Back Next > Cancel</p>
<p>Step 3: Select a Guest Operating system: Linux and select the version: Ubuntu 64-bit</p>	<p>Step 4: Enter the name for your EVE-NG-PRO VM and select Location where your EVE VM will be stored on the host PC.</p>

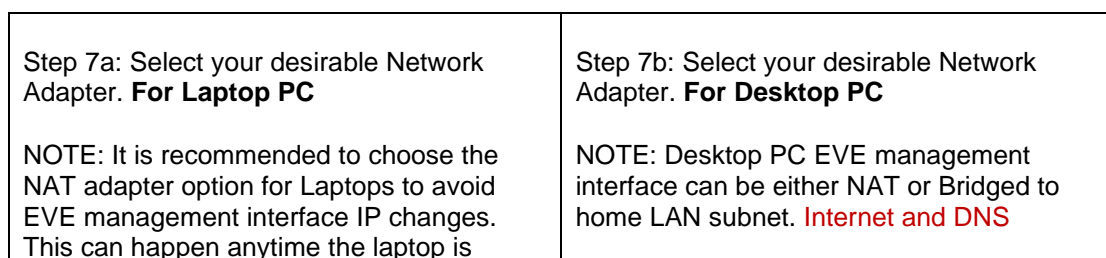
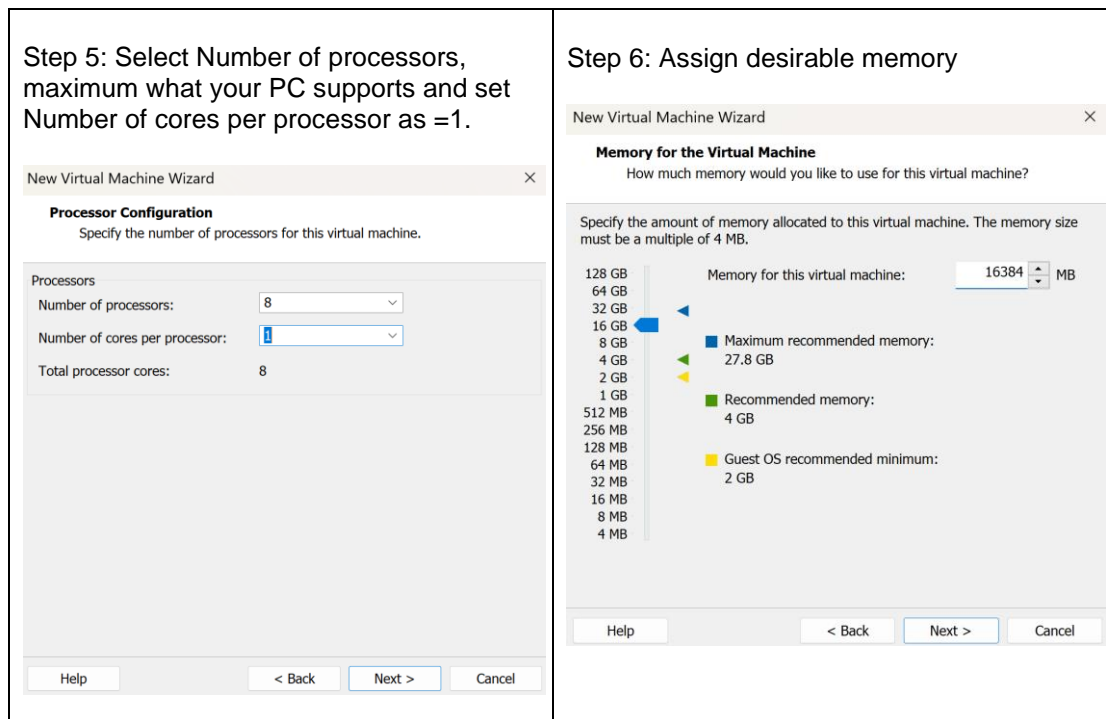
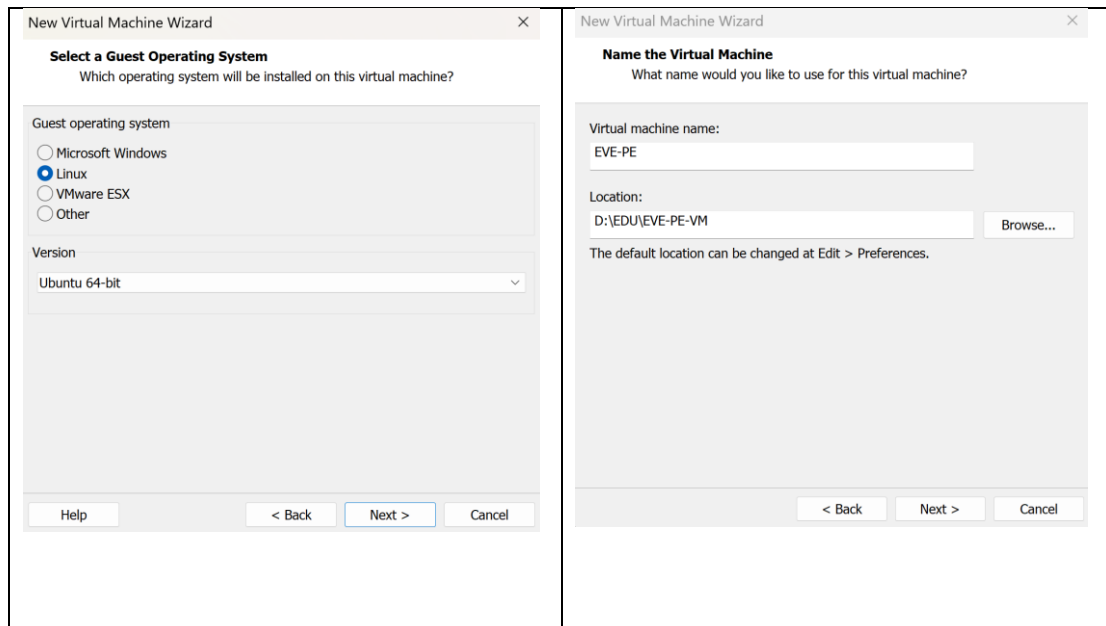

connected to a different SSID. Internet and DNS reachability is a MUST.

Network Type
What type of network do you want to add?

Network connection

- Use bridged networking
Give the guest operating system direct access to an external Ethernet network. The guest must have its own IP address on the external network.
- Use network address translation (NAT)
Give the guest operating system access to the host computer's dial-up or external Ethernet network connection using the host's IP address.
- Use host-only networking
Connect the guest operating system to a private virtual network on the host computer.
- Do not use a network connection

Help < Back Next > Cancel

reachability is a MUST.

Network Type
What type of network do you want to add?

Network connection

- Use bridged networking
Give the guest operating system direct access to an external Ethernet network. The guest must have its own IP address on the external network.
- Use network address translation (NAT)
Give the guest operating system access to the host computer's dial-up or external Ethernet network connection using the host's IP address.
- Use host-only networking
Connect the guest operating system to a private virtual network on the host computer.
- Do not use a network connection

Help < Back Next > Cancel

Step 8: Leave I/O controller Type as recommended (LSI Logic).

Select I/O Controller Types
Which SCSI controller type would you like to use for SCSI virtual disks?

I/O controller types

SCSI Controller:

- BusLogic (Not available for 64-bit guests)
- LSI Logic (Recommended)
- LSI Logic SAS
- Paravirtualized SCSI

Help < Back Next > Cancel

Step 9: Leave recommended Disk Type: SCSI

Select a Disk Type
What kind of disk do you want to create?

Virtual disk type

- IDE
- SCSI (Recommended)
- SATA
- NVMe

Help < Back Next > Cancel

Step 10: Select "Create a new virtual disk".

Select a Disk
Which disk do you want to use?

Disk

Create a new virtual disk
A virtual disk is composed of one or more files on the host file system, which will appear as a single hard disk to the guest operating system. Virtual disks can easily be copied or moved on the same host or between hosts.

Use an existing virtual disk
Choose this option to reuse a previously configured disk.

Use a physical disk (for advanced users)
Choose this option to give the virtual machine direct access to a local hard disk. Requires administrator privileges.

Buttons: Help, < Back, Next >, Cancel

Step 11: Type your desired HDD size and select "Store virtual disk as single file". It is recommended to set not less than 200GB HDD. Click Next, 2 times.

Specify Disk Capacity
How large do you want this disk to be?

Maximum disk size (GB): 200

Recommended size for Ubuntu 64-bit: 20 GB

Allocate all disk space now.
Allocating the full capacity can enhance performance but requires all of the physical disk space to be available right now. If you do not allocate all the space now, the virtual disk starts small and grows as you add data to it.

Store virtual disk as a single file

Split virtual disk into multiple files
Splitting the disk makes it easier to move the virtual machine to another computer but may reduce performance with very large disks.

Buttons: Help, < Back, Next >, Cancel

Step 12: **IMPORTANT** Press Customize Hardware

Ready to Create Virtual Machine
Click Finish to create the virtual machine. Then you can install Ubuntu 64-bit.

The virtual machine will be created with the following settings:

Name: EVE-NG-PRO
Location: D:\EVE-PRO-VM-DATA
Version: Workstation 17.5.x
Operating System: Ubuntu 64-bit

Hard Disk: 200 GB
Memory: 16384 MB
Network Adapter: Bridged (Automatic)
Other Devices: 8 CPU cores, CD/DVD, USB Controller, Sound Card

Buttons: < Back, Finish, Cancel

Step 13: Assign desired memory

Hardware

Device	Summary
Memory	16 GB
Processors	8
New CD/DVD (SATA)	Auto detect
Network Adapter	Bridged (Automatic)
USB Controller	Present
Sound Card	Auto detect
Display	Auto detect

Memory
Specify the amount of memory allocated to this virtual machine. The memory size must be a multiple of 4 MB.

Memory for this virtual machine: 16384 MB

- Maximum recommended memory (Memory swapping may occur beyond this size.): 27.8 GB
- Recommended memory: 4 GB
- Guest OS recommended minimum: 2 GB

Buttons: Add..., Remove, Close, Help

Step 14: **IMPORTANT** Set Processors “Number of processors” and “Number of cores per processor”. **Set Virtualize Intel VT-x/EPT or AMD-V/RVI to ON (checked) and set Virtualize IOMMU (checked)**

NOTE: VMware Player will display only one CPU option: Number of processors.

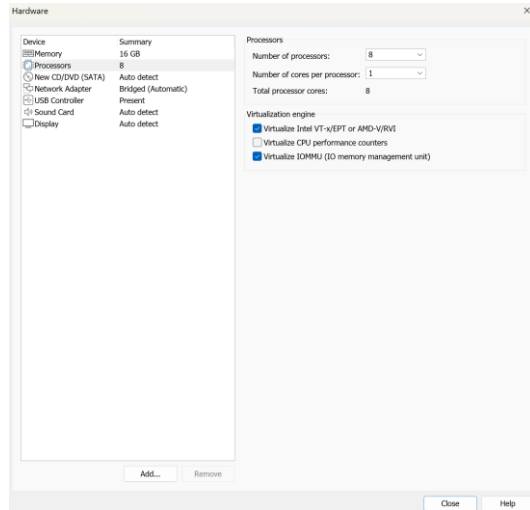

Step 15: Select CD/DVD Option: “use ISO image file.” Browse to your downloaded Full EVE-PRO.iso (actual name will be different) file

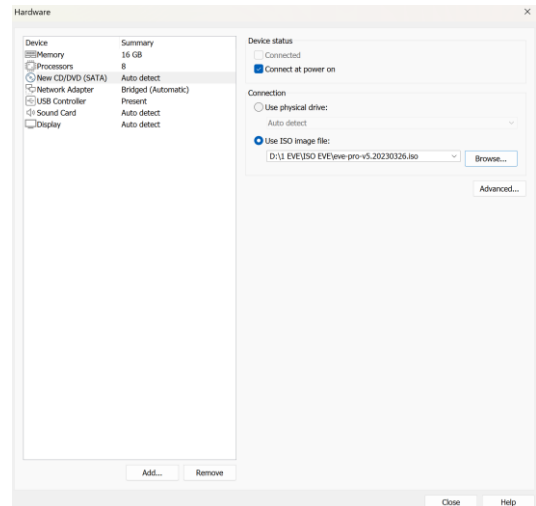

Step 16: Confirm VM Settings.

Step 17: Optional VM machine boot settings. If you are using Firmware type UEFI, make sure that enable secure boot is disabled.

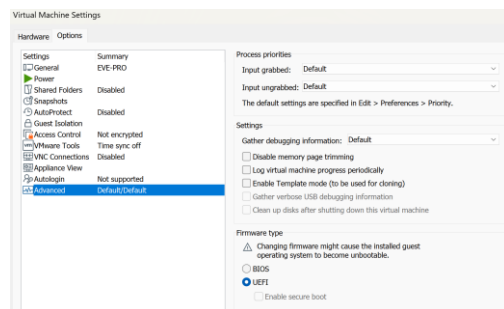

3.1.1.2 EVE-NG VM Installation steps

EVE VM Installation from ISO has 3 Phases

Phase 1 (Ubuntu installation)

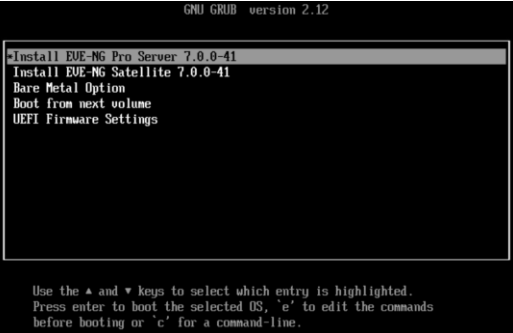
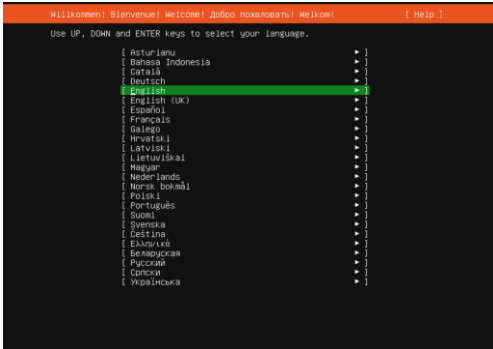
<p>Step 1: Power ON EVE VM. Chose “Install EVE NG Pro Server” and confirm with Enter.</p>  <p>GNU GRUB version 2.12</p> <pre> Install EVE-NG Pro Server 7.0.0-41 Install EVE-NG Satellite 7.0.0-41 Bare Metal Option Boot from next volume UEFI Firmware Settings </pre> <p>Use the ↑ and ↓ keys to select which entry is highlighted. Press enter to boot the selected OS, 'e' to edit the commands before booting or 'c' for a command-line.</p>	<p>Step 2: Make sure that English is selected and confirm with Enter.</p>  <pre> (Ifikome) Elinneme! welcome! dooo nooboo! no!no!no [Help] Use UP, DOWN and ENTER keys to select your language. ┌ Asturianu ├ Bahasa Indonesia ├ català ├ Deutsch ├ English ├ English (UK) ├ Español ├ Français ├ Gallego ├ Hrvatski ├ Latvian ├ Lietuviškai ├ Magyar ├ Nederlands ├ Norsk bokmål ├ Polski ├ Português ├ Suomi ├ Svenska ├ Čeština ├ Ελληνικά ├ Azərbaycanca ├ Русский ├ বাংলা ├ Українська </pre>
---	--

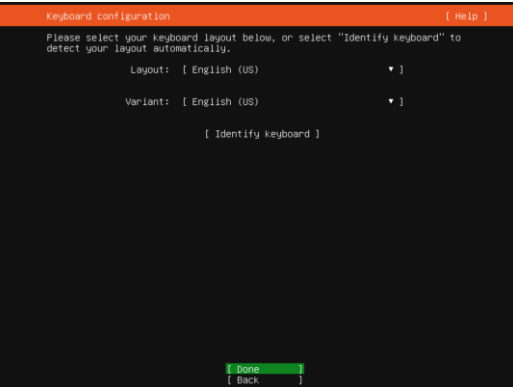
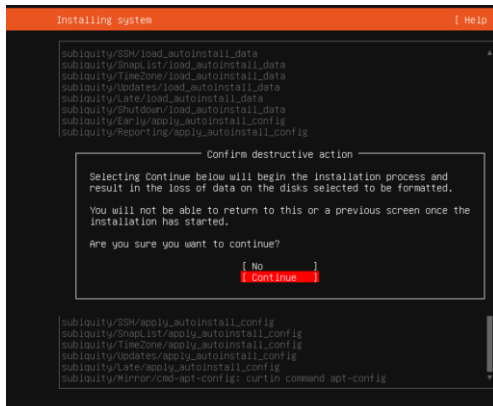
<p>Step 3: Make sure that English US Keyboard is selected and confirm with Enter.</p>  <pre> keyboard configuration [Help] Please select your keyboard layout below, or select "Identify keyboard" to detect your layout automatically. Layout: [English (US)] Variant: [English (US)] [Identify keyboard] [Done] [Back] </pre>	<p>Step 4: Select “Continue” and confirm with Enter. After completion of this task, the EVE installation will autoreboot to continue Phase 2.</p>  <pre> Installing system [Help] subiquity/SSH/load_autoinstall_data subiquity/ntp/ntp_load_autoinstall_data subiquity/Timezone/load_autoinstall_data subiquity/updates/load_autoinstall_data subiquity/later/load_autoinstall_data subiquity/shutdown/load_autoinstall_data subiquity/eye/load_autoinstall_config subiquity/reporting/apply_autoinstall_config Confirm destructive action Selecting Continue below will begin the installation process and result in the loss of data on the disks selected to be formatted. You will not be able to return to this or a previous screen once the installation has started. Are you sure you want to continue? [No] [Continue] subiquity/SSH/apply_autoinstall_config subiquity/ntp/ntp_apply_autoinstall_config subiquity/Timezone/apply_autoinstall_config subiquity/updates/apply_autoinstall_config subiquity/later/apply_autoinstall_config subiquity/eye/load_autoinstall_data subiquity/reporting/reporting_apply_autoinstall_config </pre>
--	--

EVE VM Installation Phase 2 (EVE-NG installation)

<p>Step 5: Please wait, the EVE-NG installation Phase 2 will start automatically.</p> <p>Do NOT login in this stage!</p>	<p>Step 6. After installation EVE VM will auto reboot and EVE login screen will appear, login in CLI with root/eve and follow installation</p>
--	--



EVE VM Installation Phase 3 (Management IP setup and updates)

<p>Step 7: Setup EVEs Management IP address. A Static IP address setup is preferred. Internet and DNS reachability is a MUST</p> <p>Follow steps in section:</p> <p>3.8.1 for static IP, 3.8.2 for DHCP IP</p>	<p>Step 8: Internet and DNS reachability is a MUST</p> <p>After your EVE is rebooted,</p> <p>Login to EVE CLI and type:</p> <pre>apt update apt upgrade</pre> <p>If required, follow steps in section: 5.1, 5.2</p>
---	---

NOTE: Verify your EVE-NG server installation, type “dpkg -l eve-ng-pro” command, it must display latest EVE Pro version

```
root@eve-ng:~# dpkg -l eve-ng-pro
Desired=Unknown/Install/Remove/Purge/Hold
| Status=Not/Inst/Conf-files/Unpacked/halF-conf/Half-inst/trig-aWait/Trig-pend
|/ Err?=(none)/Reinst-required (Status,Err: uppercase=bad)
||/ Name Version Architecture Description
+++-----
ii eve-ng-pro 7.0.0-XX amd64 A new generation software
for networking labs.
root@eve-ng:~#
```

Step 9: Proceed to section 4 “Obtain EVE-NG Professional license”

⚠ IMPORTANT NOTE: You must prepare and upload at least a couple of images to start building your labs. Refer to section 18

3.2 VMware ESXi

3.2.1 VMware ESXi EVE VM installation using ISO image

Download EVE-NG Professional Full ISO distribution image:

<https://www.eve-ng.net/index.php/download/>

IMPORTANT NOTE: Make sure that you have set Security Policy (Promiscuous mode, forged transmits and MAC changes) settings on the vSwitch and Port group to Accept.

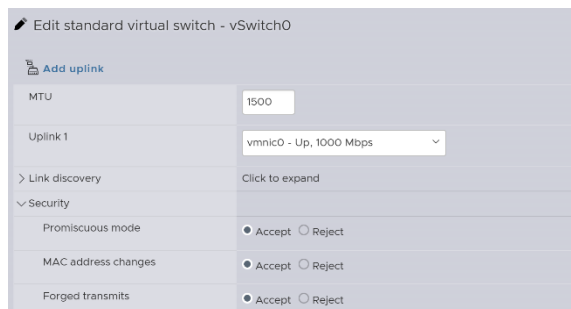

IMPORTANT NOTE: For EVE VMs running on ESXi, with NIC Teaming Network, please follow the steps below to edit the reverse path settings

- ❖ From the Navigator window select **Manage > System > Advanced settings**.
- ❖ Scroll down or use the search bar to go to the **Net.ReversePathFwdCheckPromisc** option.
- ❖ Select **Net.ReversePathFwdCheckPromisc** and click Edit option.
- ❖ In the Edit option - **Net.ReversePathFwdCheckPromisc** window update the New value field to 1 and click Save.

IMPORTANT NOTE: For EVE VMs running on ESXi, with NIC Teaming Network, managed by **vCenter and VDS Network** please follow the steps below to edit the reverse path settings

- ❖ From the Side Inventory select the ESXi host where the EVE VM is installed **Configure > System > Advanced System Settings**.
- ❖ Edit Advanced System Setting
- ❖ Scroll down to find **Net.ReversePathFwdCheckPromisc** option.

Net.ReversePathFwdCheckPromisc

1

- ❖ In the Edit option - **Net.ReversePathFwdCheckPromisc** window update the New value field to 1 and click Save.
- ❖ Reboot ESXi host
- ❖ Select the VDS Workgroup used for EVE VM networking
- ❖ Edit VDS Workgroup security setting to allow promiscuous traffic

Distributed Port Group - Edit Settings | DPortGroup-VLAN10



Download EVE-NG Professional ISO distribution image:
<https://www.eve-ng.net/index.php/download/>

3.2.1.1 EVE-NG ESXi VM Setup and Settings

Step 1: Upload EVE ISO image to the ESXi store.

Step 2: Create NEW VM

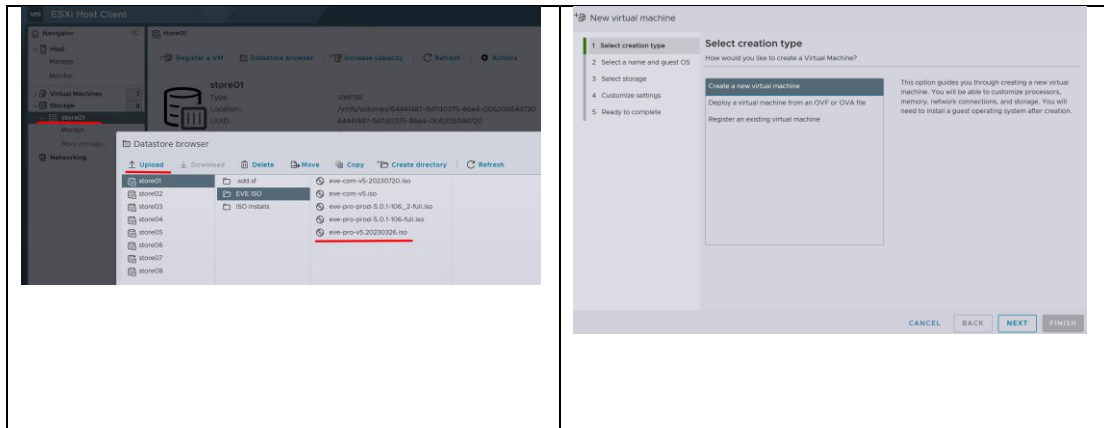

Step 3: Enter the name for your EVE-PRO VM and select Guest Operating system Linux and version: **Ubuntu 64-bit**

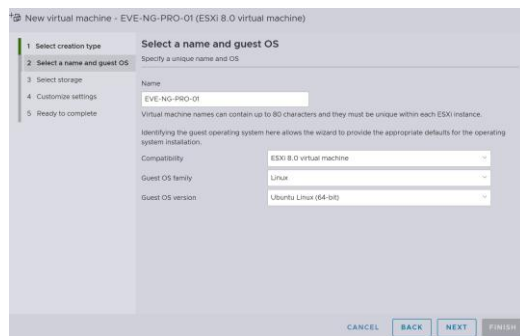

Step 4: Select Location where your EVE VM will be stored in HDD.

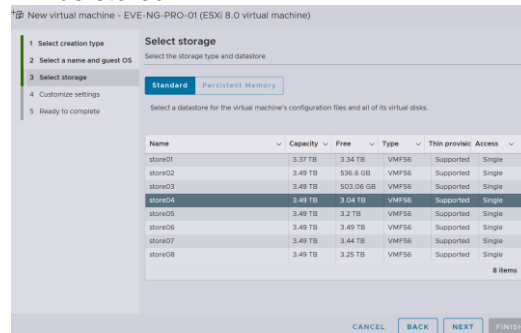

Step 5: **IMPORTANT** OPTION for ESXi 6.7.x or later.

Set Processors “Number of processors” and Set “Cores per Socket”. If your server has dual CPU, then Cores per socket will be divided by 2. Example below, shows dual CPU Server VM setup with 48 CPU with 24 cores per socket (2).

Set **Expose hardware assisted virtualization to the guest OS to ON** (checked) and set **Expose IOMMU to the guest OS to ON** (checked)

Step 6: Assign desired RAM for your EVE

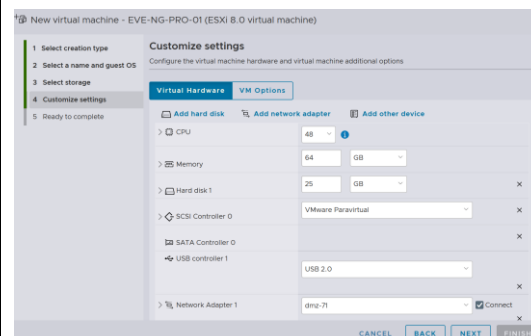

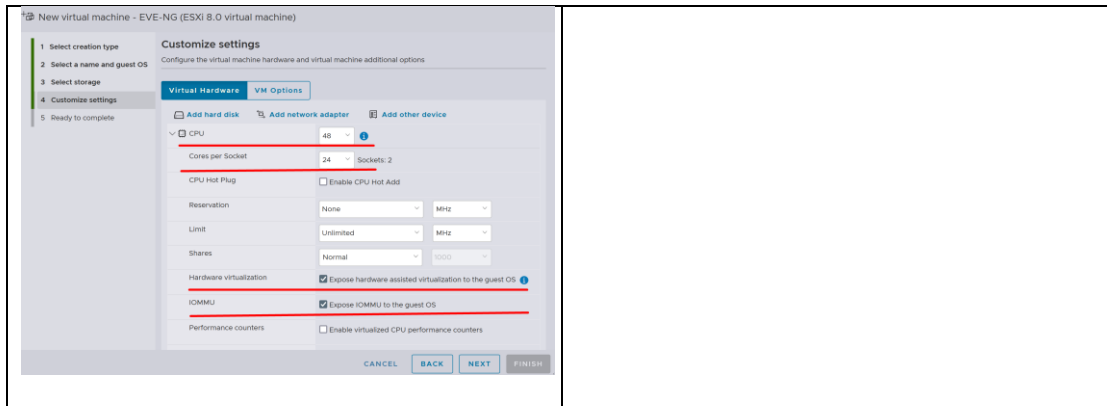

Step 7: Set the size of HDD for your new EVE VM. It is recommended to set "Thick Provisioned eagerly provisioned". Server EVE HDD is recommended to set at least 500Gb

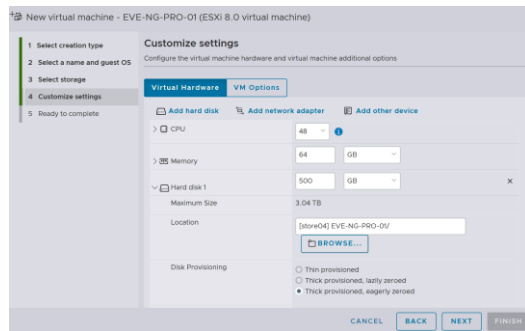

Step 8: Set your Management network. Adapter type VMXNET3

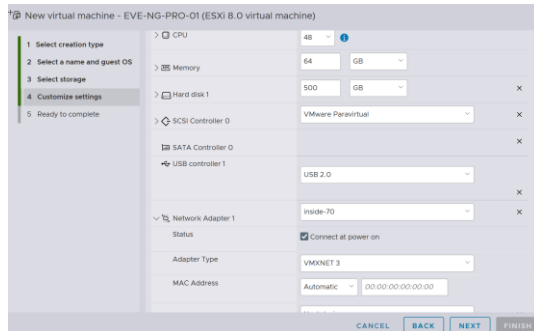

NOTE: Additional Network Adapters can be added for further use.

Step 9: Set DVD drive to "Datastore ISO File" and browse your uploaded Full-EVE-PRO.iso (ISO name can vary). Make sure that Status is checked ON, "Connect at power on"

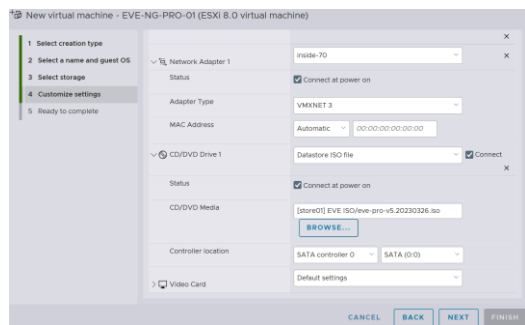

Step 10: Set DVD drive to "Datastore ISO File" and browse your uploaded Full-EVE-PRO.iso (EVE ISO name can vary). Make sure that Status is checked ON, "Connect at power on" Hit the "Finish"

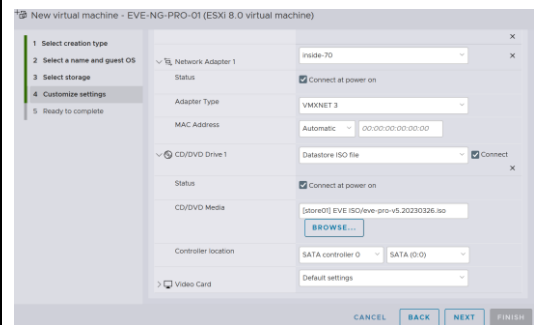

Step 11: **IMPORTANT** If you are using ESX 8.0 or later, select the Edit your VM and switch to “VM Options”. Firmware *EFI Boot*.

Follow to “Boot Options” and **de-select (uncheck) “Whether or not to enable UEFI Secure boot for this VM”**

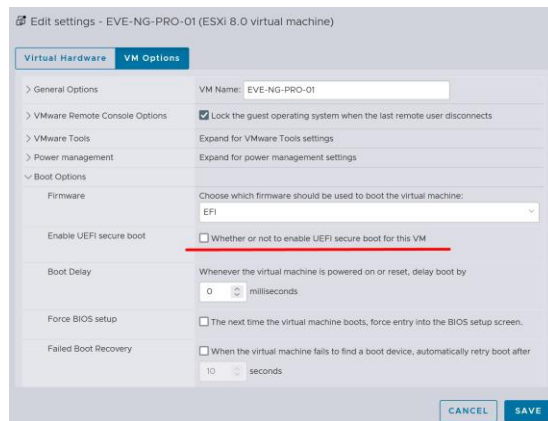

Step 12: Start VM and follow by 3.4

3.3 Proxmox VE

3.3.1 Proxmox VE EVE VM installation using ISO image

Download EVE-NG Professional Full ISO distribution image:
<https://www.eve-ng.net/index.php/download/>

3.3.1.1 EVE-NG VM Setup and Settings

Step 1: Upload EVE ISO image to the Proxmox VE store.

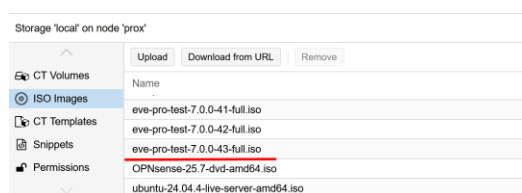

Step 2: Create NEW VM, and set the name for your VM. Following by Next.

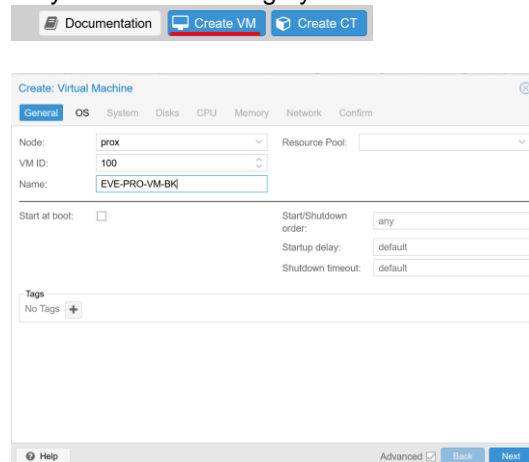

Step 3: OS tab. Select storage and ISO image. Following by Next.

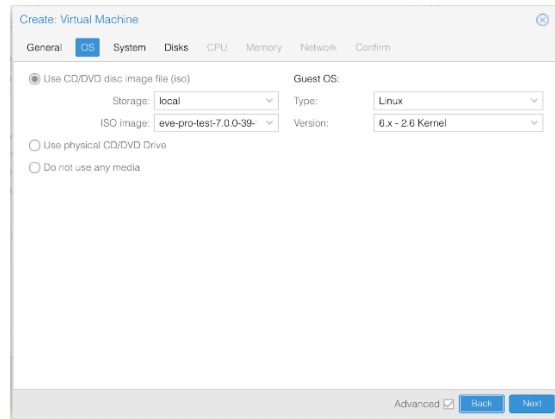

Step 4: System tab. Check the Graphic Card (Default) and Machine (i440fx) is selected. Select BIOS: OVMF (UEFI) for installation as well. Check option Add EFI Disk and select your preferred HDD storage for it. Uncheck option Pre-Enrolled keys. Qemu Agent: Checked. Add TPM: Unchecked. Following by Next.

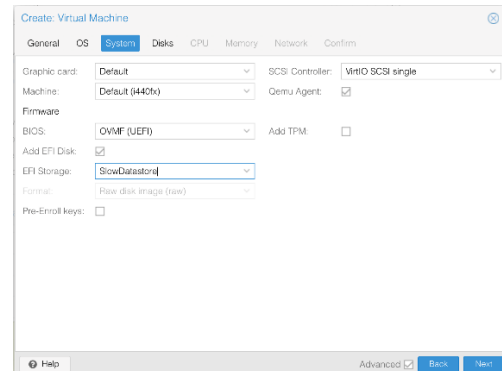

Step 5: Disks tab. Select Bus/Device: VirtIO Block. Select the storage where your EVE VM HDD will be located. Select the size of your EVE VM. Recommended is to select 200GB or more. Following by Next.

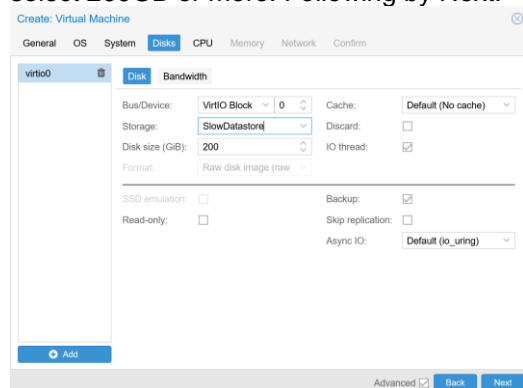

Step 6: CPU tab. Select the Sockets your Proxmox VE server have and select the cores per socket. In the example below is 1x socket with 32 cores per socket. **IMPORTANT:** Your Proxmox VE CPU must support nested virtualization. Select Type: **Host**. Host will read all flags from your HW CPU and will use it for VM. Following by Next.

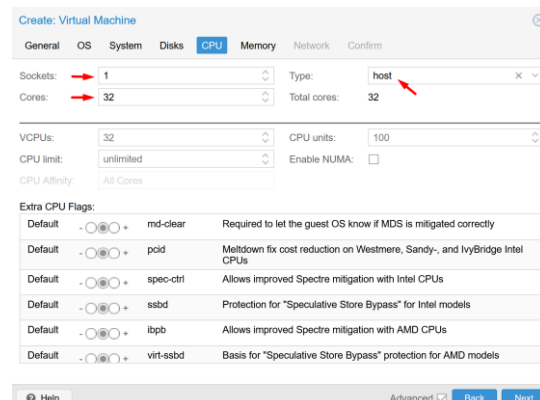

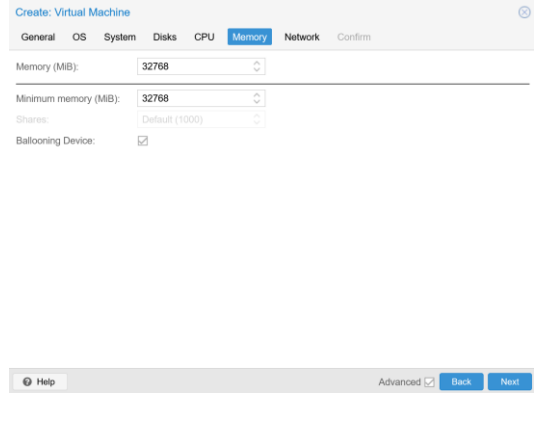
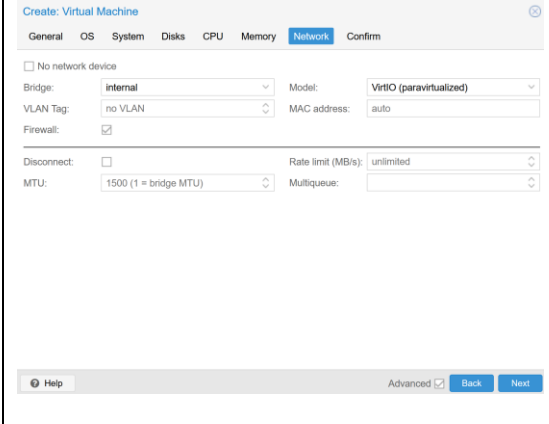
<p>Step 7: Memory tab. Set the size of Memory in MB. Following by Next.</p> 	<p>Step 8: Network tab. Set your Management interface network. Following by Next.</p> 
--	---

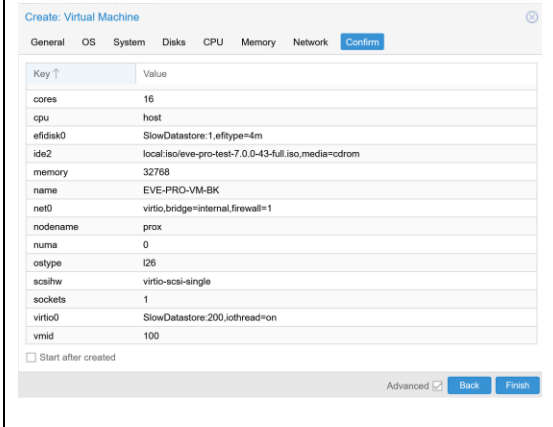
<p>Step 9: Confirm tab. Check your VM settings. Following by Finish</p> 	<p>Step 10: Start VM and follow by 3.4</p>
--	---

3.4 EVE-NG VM Installation steps

EVE VM Installation from ISO has 3 Phases

Phase 1 (Ubuntu installation)

<p>Step 1: Power ON EVE VM. Chose Install EVE-NG Pro Server and confirm with Enter.</p>	<p>Step 2: Select English language. Confirm with Enter.</p>
--	--

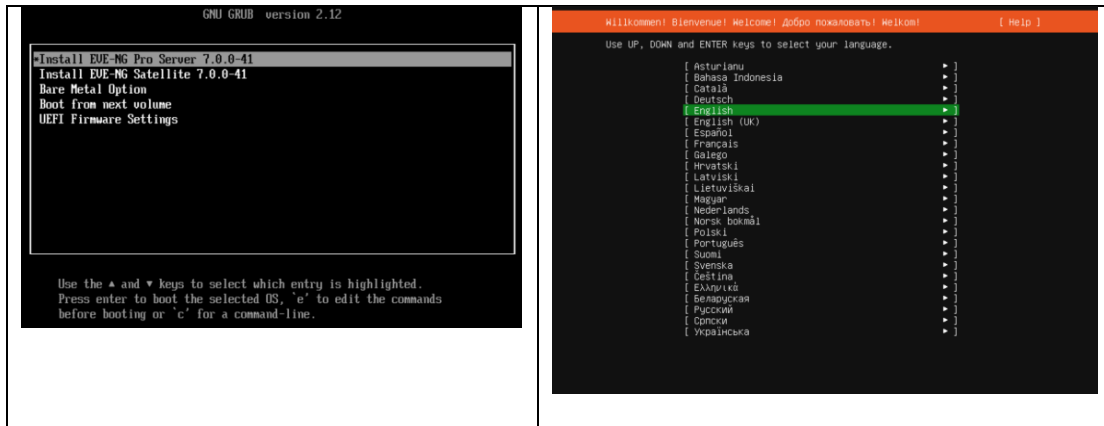

Step 3: Make sure if English US keyboard is selected and confirm with Enter.

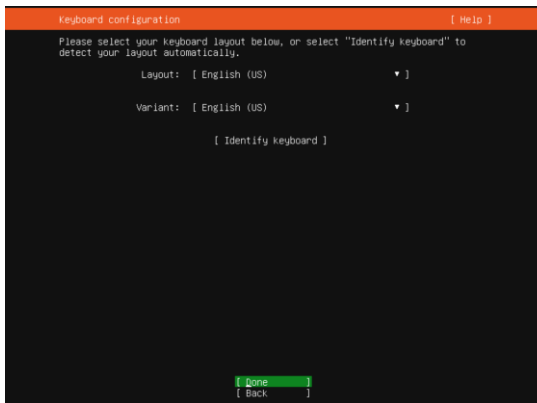

Step 4: Select "Continue" and confirm with Enter.

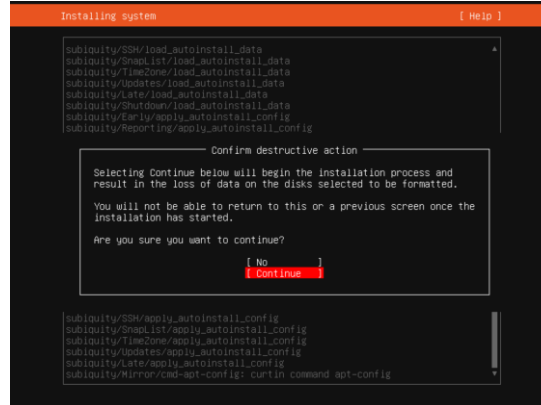

EVE VM Installation Phase 2 (EVE-NG installation)

Step 5: Please wait, the EVE-NG installation **Phase 2** will start automatically.

Do NOT login in this stage!

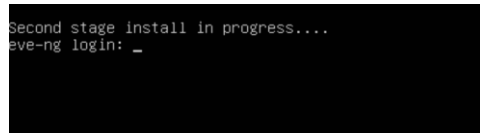

Step 6. After installation EVE VM will **auto reboot** and EVE login screen will appear, login in CLI with **root/eve** and follow installation Phase 3

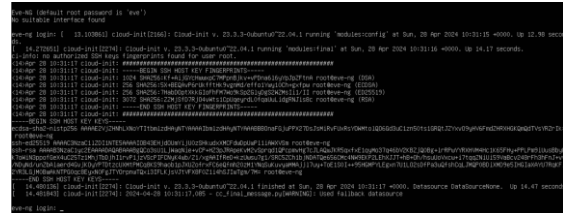

EVE VM Installation Phase 3 (Management IP setup and updates)

Step 7: Setup EVEs Management IP address. A Static IP address setup is

Step 8: **Internet and DNS reachability is a MUST**

<p>preferred. Internet and DNS reachability is a MUST</p> <p>Follow steps in section:</p> <p>3.8.1 for static IP, 3.8.2 for DHCP IP</p>	<p>After your EVE is rebooted,</p> <p>Login to EVE CLI and type:</p> <pre>apt update apt upgrade</pre> <p>If required, follow steps in section: 5.1, 5.2</p>
--	---

NOTE: Verify your EVE-NG server installation, type “dpkg -l eve-ng-pro” command, it must display latest EVE Pro version (please note that version of EVE-PRO will be newest)

```
root@eve-ng:~# dpkg -l eve-ng-pro
Desired=Unknown/Install/Remove/Purge/Hold
|          Status=Not/Inst/Conf-files/Unpacked/halF-conf/Half-inst/trig-
aWait/Trig-pend
|/ Err?=(none)/Reinst-required (Status,Err: uppercase=bad)
||/ Name                Version                Architecture
Description
+++-----
=====
ii  eve-ng-pro             7.0.0-XX              amd64             A
new generation software for networking labs.
root@eve-ng:~#root@eve-sat01:~#
```

NOTE: If your newly installed EVE-PRO shows nothing like above, you must check your internet reachability and verify DNS configuration on your EVE-PRO server.

```
root@eve-ng:~# ping www.google.com
PING www.google.com (172.217.22.164) 56(84) bytes of data.
64 bytes from arn09s11-in-f164.1e100.net (172.217.22.164): icmp_seq=1
ttl=120 time=8.84 ms
64 bytes from arn09s11-in-f164.1e100.net (172.217.22.164): icmp_seq=2
ttl=120 time=8.84 ms
^C
--- www.google.com ping statistics ---
2 packets transmitted, 2 received, 0% packet loss, time 1001ms
rtt min/avg/max/mdev = 8.848/8.848/8.849/0.094 ms
root@eve-ng
```

Step 9: Go to section 4 to obtain a license for EVE-NG Professional

- ⚠ **IMPORTANT NOTE:** If your Network interfaces order has been changed, please follow instruction to section **17.7**
- ⚠ **IMPORTANT NOTE:** You must prepare and upload at least a couple of images to start building your labs. Refer to section **18**

3.5 Bare hardware (BM) server installation

3.5.1 BM Server installation EVE ISO

- ⚠ **IMPORTANT NOTE:** The bare server HDD system Raid, etc or single virtual drive, must be set before you start installation!
- ⚠ **Bare Metal Server Bare metal BIOS, System and Security settings**

Navigate to System BIOS Settings > Boot Settings:

Boot Mode > UEFI

Navigate to System BIOS Settings > Processor Settings:

**Set Virtualization Technology to Enabled
Set X2APIC Mode to Enabled**

Navigate to System BIOS Settings > Integrated Devices:

**Set SR-IOV Global Enable to Enabled
Set I/OAT DMA Engine to Enabled**

Navigate to System BIOS Settings > System Security:

**TPM Security: OFF
Secure Boot: Disabled**

Download EVE-NG Professional Full ISO distribution image:

<https://www.eve-ng.net/index.php/download/>

Phase 1 (Ubuntu installation)

Step 1: Create a bootable DVD disk or USB flash drive (*Rufus tool is strongly recommended*) with a Full EVE ISO image. Boot your server from ISO. Chose Bare metal Option, following by Install BM EVE-NG Pro Server and confirm with Enter.



Step 2: Select English language. Confirm with Enter.

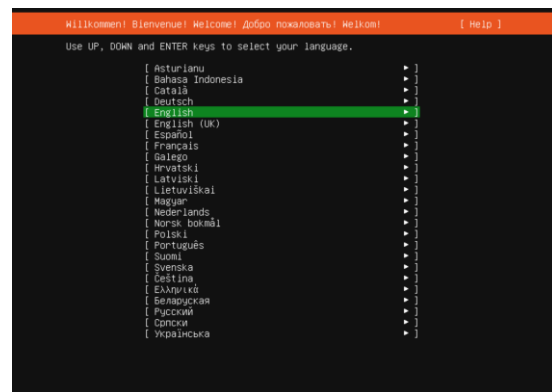

Step 3: Make sure if English US keyboard is selected and confirm with Enter.

Step 4: Select [X] "Use an entire disk" and [X] Set up this disk as and LVM group confirm with Enter. For advnaced (multi hdd as single LVM) setup it can be Custom

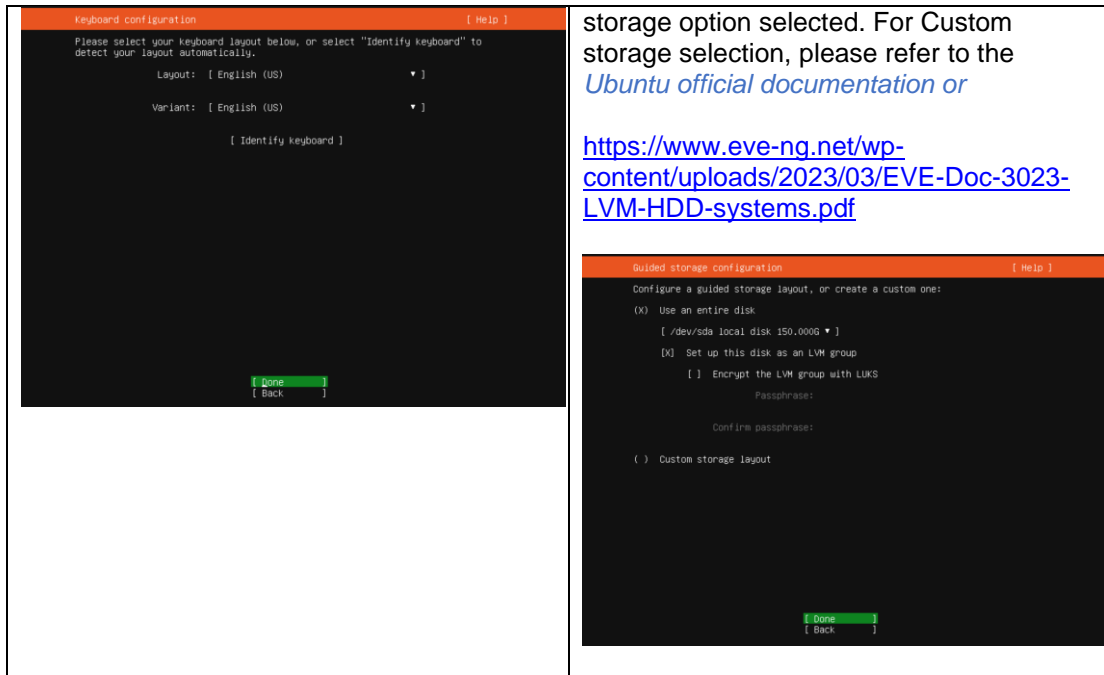

storage option selected. For Custom storage selection, please refer to the [Ubuntu official documentation](https://www.ubuntu.com/docs/lvm-hdd-systems) or <https://www.eve-ng.net/wp-content/uploads/2023/03/EVE-Doc-3023-LVM-HDD-systems.pdf>

EVE VM Installation Phase 2 (EVE-NG installation)

<p>Step 5: Please wait, the EVE-NG installation Phase 2 will start automatically. Do NOT login in this stage!</p> <pre>Second stage install in progress... eve-ng login: _</pre>	<p>Step 6. After installation EVE VM will auto reboot and EVE login screen will appear, login in CLI with root/eve and follow installation Phase 3</p> <pre>root@kali:~# ssh root@192.168.1.100 Warning: Permanently added '192.168.1.100' (ssh) to the list of known hosts. root@eve:~#</pre>
---	--

EVE VM Installation Phase 3 (Management IP setup and updates)

<p>Step 7: Setup EVEs Management IP address. A Static IP address setup is preferred. Internet and DNS reachability is a MUST</p> <p>Follow steps in section: 3.8.1 for static IP, 3.8.2 for DHCP IP</p>	<p>Step 8: Internet and DNS reachability is a MUST</p> <p>After your EVE is rebooted,</p> <p>Login to EVE CLI and type:</p> <pre>apt update apt upgrade</pre> <p>If required, follow steps in section: 5.1, 5.2</p>
--	---

Verification: Verify your EVE-NG server installation, type “dpkg -l eve-ng-pro” command, it must display latest EVE Pro version

```
root@eve-ng:~# dpkg -l eve-ng-pro
Desired=Unknown/Install/Remove/Purge/Hold
| Status=Not/Inst/Conf-files/Unpacked/halF-conf/Half-inst/trig-aWait/Trig-pend
|/ Err?=(none)/Reinst-required (Status,Err: uppercase=bad)
||/ Name                               Version                               Architecture
Description
+++-----
ii  eve-ng-pro                             7.0.0-XX                             amd64          A
new generation software for networking labs.
root@eve-ng:~#
```

<p>Step 9: (Optional) Air-Gapped Bare metal EVE Server setup from ISO can skip auto docker installation due slow iLO, iDRAC etc. virtual media connection to the server. For manual dockers installation, upload EVE-NG installation ISO to your EVE server location: /tmp/. From CLI locate to the location and start dockers installation: cd /tmp/ root@eve-master:/tmp# ls eve-pro-prod-bm-7.0.1-9-full.iso root@eve-master:install-iso-dockers This method can be used for master server and the satellite servers either.</p>	<p>Step 10: Continue to section 4 to obtain your EVE-NG Professional license</p>
---	--

- ⚠ **IMPORTANT NOTE:** If your Network interfaces order has been changed, please follow instruction to section 17.7
- ⚠ **IMPORTANT NOTE:** You must prepare and upload at least a couple of images to start building your labs. Refer to section 18

3.5.2 BM Server Installation Ubuntu legacy ISO

- ⚠ **IMPORTANT NOTE:** The bare server HDD system RAID, etc or single virtual drive, must be set before you start installation!
- ⚠ **Mandatory Prerequisites:** Internet and DNS must be reachable from your Server. This ISO installation requires internet access to get updates and install the latest EVE-PRO version from the EVE-NG repository. DNS must resolve names!
- ⚠ **Bare Metal Server Bare metal BIOS, System and Security settings**

Navigate to System BIOS Settings > Boot Settings:

Boot Mode > UEFI

Navigate to System BIOS Settings > Processor Settings:

Set Virtualization Technology to Enabled Set X2APIC Mode to Enabled

Navigate to System BIOS Settings > Integrated Devices:

Set SR-IOV Global Enable to Enabled

Set I/OAT DMA Engine to Enabled

Navigate to System BIOS Settings > System Security:
TPM Security: OFF
Secure Boot: Disabled

Download Ubuntu Legacy Server installation image/ISO
<https://releases.ubuntu.com/noble/>

Phase 1 (Ubuntu installation)

Step 1: Create a bootable DVD disk or USB flash drive (*Rufus tool is strongly recommended*) with an Ubuntu server image. Boot your server from ISO. Select English language. Confirm with Enter.

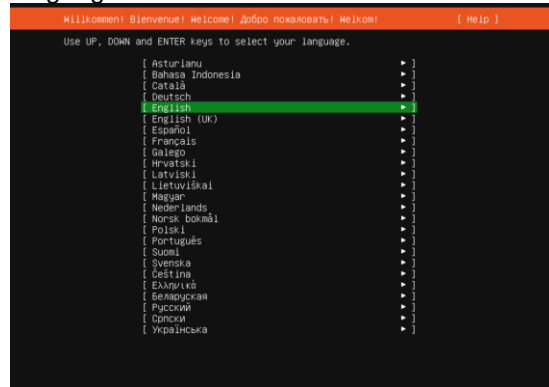

Step 2: Select Option Update to the new installer, following by Enter.

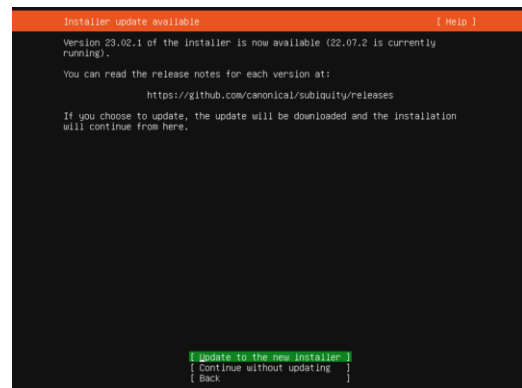

Step 3: Make sure if English US keyboard is selected and confirm with Done/Enter.

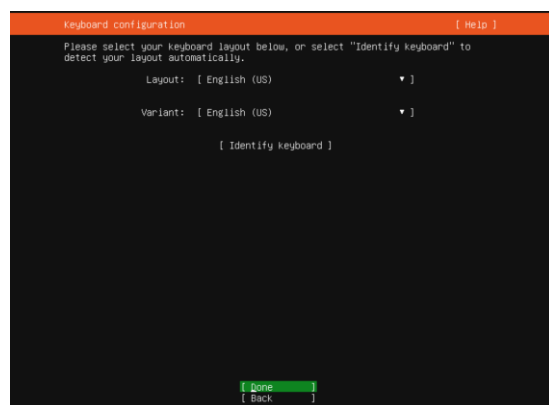

Step 4: Select Option Ubuntu Server [X], following by Done/Enter.

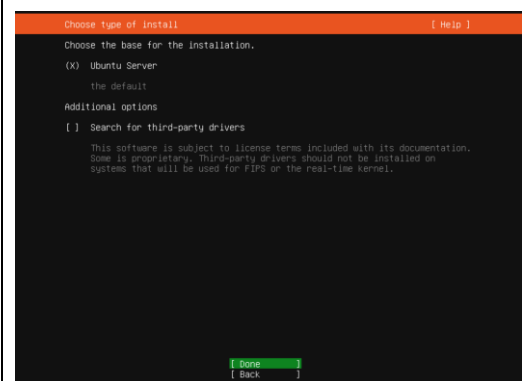

Step 5: If your network has **DHCP ENABLED**, Continue to **Step 11**

Step 6: If your network has not **DHCP**. Static IP setup. If you have not enabled DHCP in the network, you must assign an IP address manually. Use arrow UP key to select your interface for IP address.assignment.

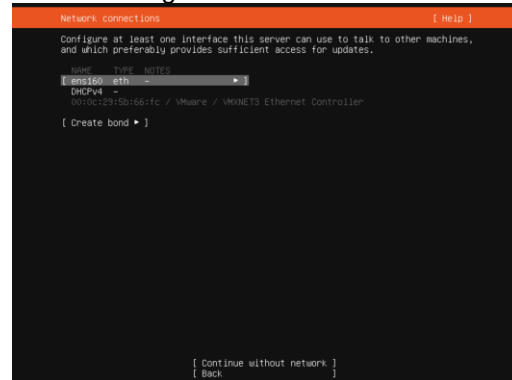

Step 7: Confirm interface selection with Enter, select "Edit IPv4" and confirm with Enter again.

Step 8: Hit Enter on IPv4 Method and select "Manual", confirm with Enter.

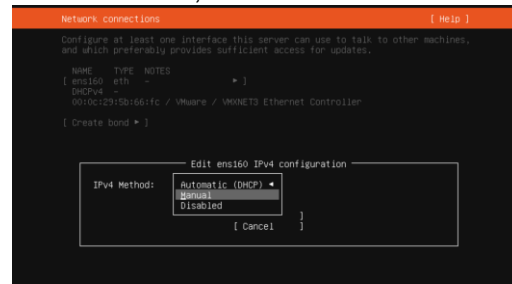
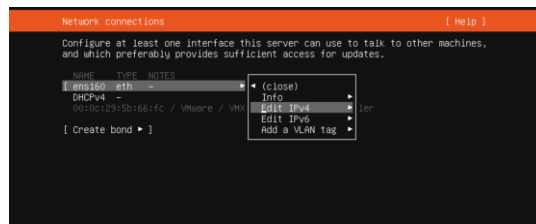

Step 9: Enter your "Subnet", "IP Address", "Gateway IP", "Domain server IPs" and "Search domain". Select "Save" and confirm with Enter. **NOTE, it is very important that your DNS (Name servers) will resolve Internet names.**

Step 10: Select "Done" and confirm with Enter

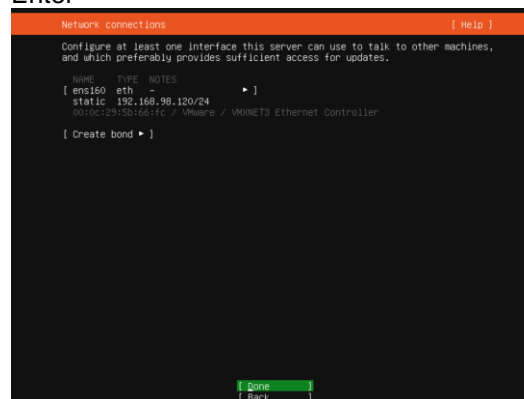
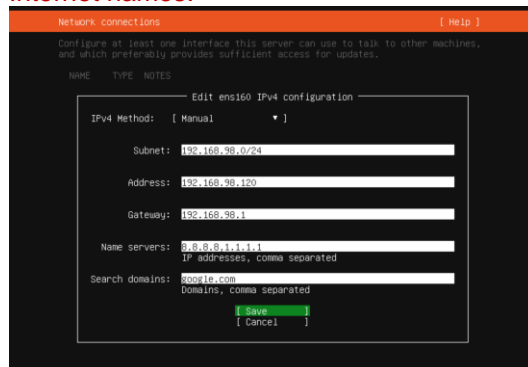

Step 11: If your DHCP IP settings are correct, select Done and confirm with Enter.

```

Network connections [ Help ]
Configure at least one interface this server can use to talk to other machines,
and which preferably provides sufficient access for updates.

Name      Type  Notes
-----
[ ens160  eth  ]
DHCPv4    192.168.90.111/24
00:0c:29:5b:66:1c / VMware / VMNET3 Ethernet Controller

[ Create bond ]

[ Done ]
[ Back ]

```

Step 12: If you have proxy in use for your internet, assign your network proxy settings. If no proxy in use, with Tab key select Continue and confirm with Enter.

```

Configure proxy [ Help ]
If this system requires a proxy to connect to the internet, enter its details
here.

Proxy address: [ ]
If you need to use a HTTP proxy to access the outside world,
enter the proxy information here. Otherwise, leave this blank.

The proxy information should be given in the standard form of
"http://[user]@[pass]@host[:port]/".

[ Done ]
[ Back ]

```

Step 13: Select [X] "Use an entire disk" and [X] Set up this disk as and LVM group confirm with Enter. For advanced (multi hdd as single LVM) setup it can be Custom storage option selected. For Custom storage selection, please refer to the [Ubuntu official documentation](https://www.ubuntu.com/server/docs/storage/raid) or

<https://www.eve-ng.net/wp-content/uploads/2023/03/EVE-Doc-3023-LVM-HDD-systems.pdf>

```

Guided storage configuration [ Help ]
Configure a guided storage layout, or create a custom one:

(x) Use an entire disk
   [ /dev/sda local disk 150.000G ]
(x) Set up this disk as an LVM group
   [ ] Encrypt the LVM group with LUKS
      Passphrase:
      Confirm passphrase:

( ) Custom storage layout

[ Done ]
[ Back ]

```

Step 14: Select "Continue" and confirm with Enter.

```

Installing system [ Help ]

subiquity/SSH/load_autoinstall_data
subiquity/SnapList/load_autoinstall_data
subiquity/TimeZone/load_autoinstall_data
subiquity/updates/load_autoinstall_data
subiquity/Late/load_autoinstall_data
subiquity@bootenv/load_autoinstall_data
subiquity/Early/apply_autoinstall_config
subiquity/Reporting/apply_autoinstall_config

Confirm destructive action
Selecting Continue below will begin the installation process and
result in the loss of data on the disks selected to be formatted.
You will not be able to return to this or a previous screen once the
installation has started.

Are you sure you want to continue?

[ No ]
[ Continue ]

subiquity/SSH/apply_autoinstall_config
subiquity/SnapList/apply_autoinstall_config
subiquity/TimeZone/apply_autoinstall_config
subiquity/updates/apply_autoinstall_config
subiquity@late/apply_autoinstall_config
subiquity@late/apply_autoinstall_config
subiquity/Mirror/cad-apt-config: curl command apt-config

```

Step 15: Confirm your HDD configuration Done/Enter

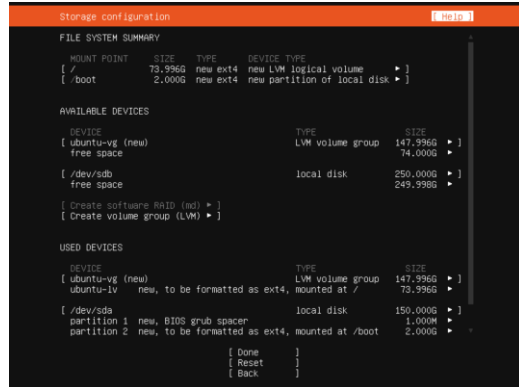

Step 16: Select “Continue” and confirm with Enter.

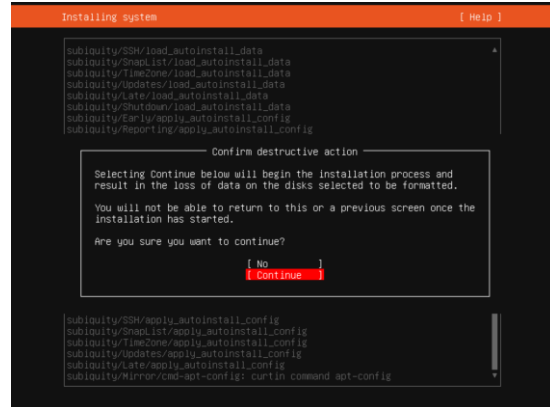

Step 17: Fill the *non-root user* profile following by Done/Enter

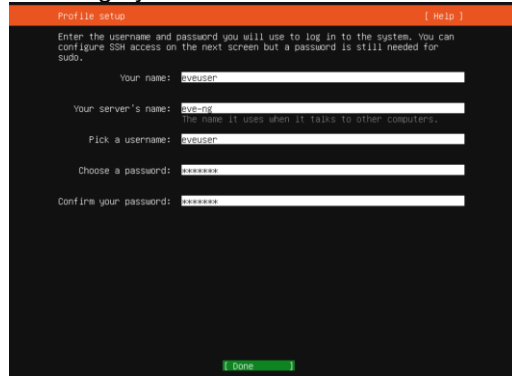

Step 18: Skip Ubuntu Pro installation Continue confirm with Enter.

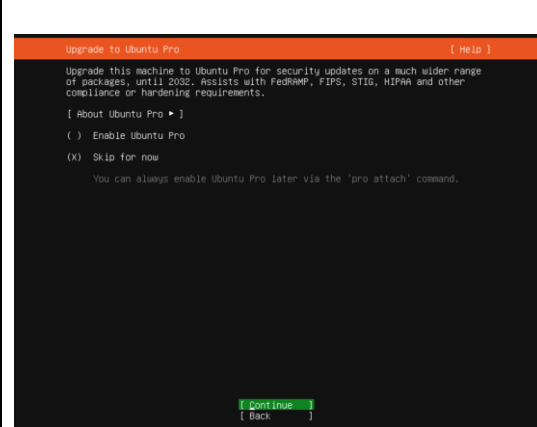

Step 19: Select [X] “Install OpenSSH Server” and confirm Done/Enter.

Step 20: Select “Continue” and confirm with Enter.

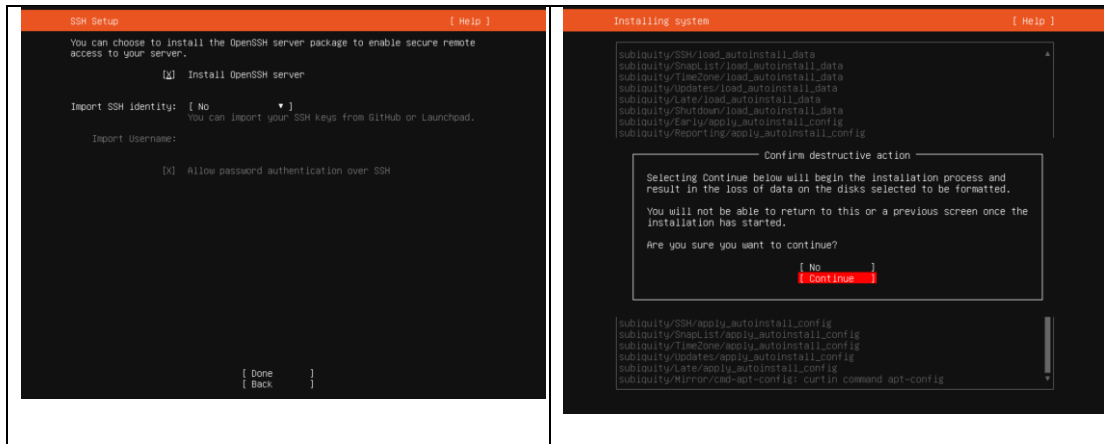

Step 21: DO NOT Select any other services confirm Done/Enter.

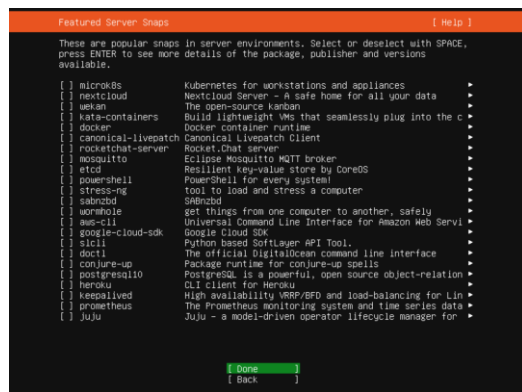

Step 22: Select "Continue" and confirm with Enter.

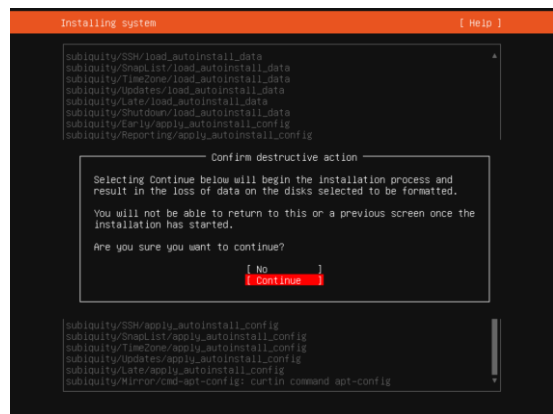

Step 23: After the Ubuntu "Install Complete" select "Reboot Now" and hit Enter to continue.

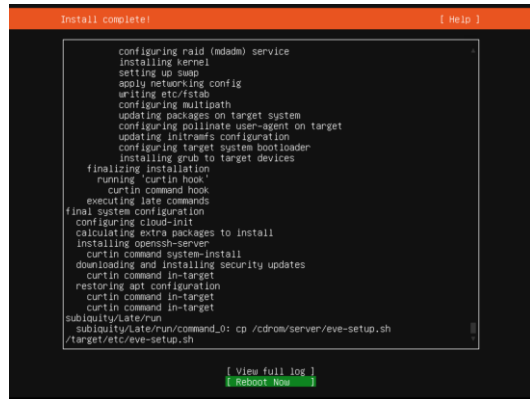

Step 24: Remove CD/DVD ISO Media following by Enter.

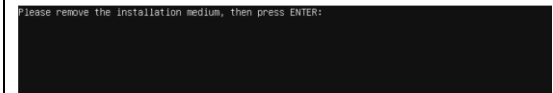

Step 25: Login into your Ubuntu server with previously created non-root user: eveuser/test123

```

Install complete! [ help ]

running 'curtin in-target -- setupcon --save-only'
curtin command in-target
running 'curtin curthooks'
curtin command curthooks
  configuring apt
  configuring apt
  installing missing packages
  configuring iscsi service
  configuring fcid (mdadm) service
  installing kernel
  setting up swap
  apply networking config
  writing etc/fstab
  configuring multipath
  updating packages on target system
  configuring pollinate user-agent on target
  updating initramfs configuration
  configuring target system boot loader
  installing grub to target devices
final system configuration
  configuring cloud-init
  calculating extra packages to install
  installing openssh-server
  curtin command system-install
  downloading and installing security updates
  curtin command in-target
  restoring apt configuration
  curtin command in-target
subiquity/Late/run

[ View full log ]
[ Reboot Now ]

```

Step 26: IMPORTANT: Set root user password, Example:

```

sudo su
test123
passwd root
eve
eve

```

```

eveuser@eve-ng:~$ sudo su
[sudo] password for eveuser:
root@eve-ng:/home/eveuser# cd
root@eve-ng:~# sudo passwd root
New password:
Retype new password:
passwd: password updated successfully
root@eve-ng:~# _

```

Step 26: Allow permissions for root administrator user SSH to your server.

```
nano /etc/ssh/sshd_config
```

Edit to: PermitRootLogin yes
 Edit to:
 KbdInteractiveAuthentication yes
 ctrl+o Enter for save
 ctrl+x for exit
 restart ssh service
 service sshd restart

```

# OpenSSH: sshd_config,v 1.101 2017/02/14 07:19:07 djm Exp #
# This is the sshd server system-wide configuration file. See
# sshd_config(5) for more information.
# This sshd was compiled with PATH=/usr/bin:/bin:/usr/sbin:/sbin
# The strategy used for options in the default sshd_config shipped with
# OpenSSH is to specify options with their default value where
# possible, but leave them commented. Uncommented options override the
# default value.
#Port 22
AddressFamily any
#ListenAddress 0.0.0.0
ListenAddress ::
#HostKey /etc/ssh/ssh_host_rsa_key
#HostKey /etc/ssh/ssh_host_ecdsa_key
#HostKey /etc/ssh/ssh_host_ed25519_key
# Ciphers and keying
#KexAlgorithms default none
# Logging
#SyslogFacility AUTH
#LogLevel INFO
# Authentication:
#LoginGraceTime 2m
PermitRootLogin yes
# To disable tunneled clear text passwords, change to no here!
#PasswordAuthentication yes
#PermitEmptyPasswords no
# Change to yes to enable challenge-response passwords (beware issues with
# some PAM modules and threads)
KbdInteractiveAuthentication yes

```

Step 27: IMPORTANT: Set root user password, Example:

```

sudo su
test123
passwd root
eve
eve

```

```

eveuser@eve-ng:~$ sudo su
[sudo] password for eveuser:
root@eve-ng:/home/eveuser# cd
root@eve-ng:~# sudo passwd root
New password:
Retype new password:
passwd: password updated successfully
root@eve-ng:~# _

```

EVE Installation Phase 2 (EVE installation)

Step 28: SSH to your EVE IP using Putty or other SSH client. Log in as root user execute:

```
apt update
apt upgrade
```

Step 29: Run EVE Pro online installation script. (Please do commands one by one below)

```
wget https://www.eve-ng.net/noble/install-eve-pro.sh
chmod +x install-eve-pro.sh
./install-eve-pro.sh
```

At the end of eve server installation, reboot eve

EVE Installation Phase 3 (Management IP setup and updates)

Step 30: After reboot SSH to your EVE IP as root and Setup EVE Management IP address. A Static IP address for BM setup is preferred.

Follow steps in section : **3.8.1** for static IP, **3.8.2** for DHCP IP

```
apt remove netplan.io
```

Step 31: After your EVE is rebooted, Login to EVE CLI and type:

```
apt update
apt upgrade
```

Verification: Verify your EVE-NG server installation, type “dpkg -l eve-ng-pro” command, it must display latest EVE Pro version

```
root@eve-ng:~# dpkg -l eve-ng-pro
Desired=Unknown/Install/Remove/Purge/Hold
| Status=Not/Inst/Conf-files/Unpacked/half-Conf/Half-Inst/trig-await/Trig-pend
|/ Err?=(none)/Reinst-required (Status,Err: uppercase=bad)
||/ Name Version Architecture
Description
+++-----
ii eve-ng-pro 7.0.0-XX amd64 A
new generation software for networking labs.
root@eve-ng:~#
```

Step 32: **IMPORTANT** After update, Step 32 is completed, continue with type:

```
apt install eve-ng-dockers
```

This can take some time depending on your Internet connection and disk speed.

Step 33: (Optional) If after dockers first install (Step 32) in the output “dc images” you still seeing some docker name in the list as <none>,

```
REPOSITORY TAG IMAGE ID CREATED SIZE
eve-ng-dockers/dc-images
eve-ng-dockers/eve-ng-dockers latest 78692818a5 18 seconds ago 1.42GB
eve-ng-dockers/eve-ng-server latest 736609e9a5 5 minutes ago 1.04GB
eve-ng-dockers/eve-ng-vireshark latest 638ed7c15b80 12 minutes ago 897MB
eve-ng-dockers/eve-ng-jitsi latest 8593207107 13 minutes ago 1.42GB
eve-ng-dockers/eve-ng-desktop latest 78692818a5 15 minutes ago 1.76GB
```

please run the command:

```
apt install --reinstall eve-ng-dockers
```

<p>Your output after install must look like:</p> <pre>root@eve-ng:~# dc images REPOSITORY TAG IMAGE ID CREATED SIZE eve-desktop latest ca113621bd7 12 hours ago 3.65GB eve-gui-server latest 9ab19c879a17 2 days ago 3.04GB eve-firefox latest 0266d109a1bb 7 weeks ago 2.12GB eve-mysql57 latest 82a009773e89 7 weeks ago 1.56GB root@eve-ng:~#</pre> <p>dc images</p>	<p>NOTE: If you are installing EVE in the locked environment and cannot install dockers online, please contact with us: info@eve-ng.net for offline dockers installation option.</p>
---	---

Step 34: Continue to section 4 to obtain your EVE-NG Professional license

- ⚠ **IMPORTANT NOTE:** If your Network interfaces order has been changed, please follow instruction to section 17.7
- ⚠ **IMPORTANT NOTE:** You must prepare and upload at least a couple of images to start building your labs. Refer to section 18

3.6 Google Cloud Platform

3.6.1 Google account

Step 1: Connect to Google Cloud Platform (GCP)
<https://console.cloud.google.com/getting-started>

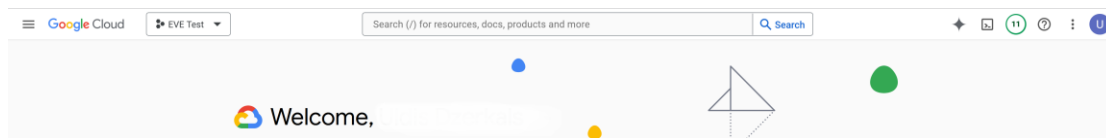

Step 2: Sign into GCP. Create a new GCP account if you do not already have one.
Step 3: Open your Google Project which assigned to your Google account

3.6.2 Preparing Ubuntu boot disk template

Step 1: On the left side navigate to Compute Engine and press “Activate Cloud Shell”

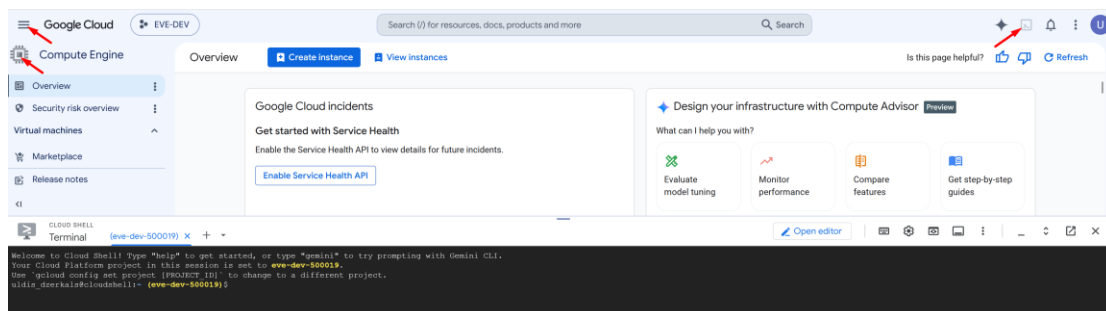

Step 2: Create a nested Ubuntu 24.04 image. Copy and paste the below command into the shell. Use copy/paste. ctrl +c/ctrl +v. **It is single line command.** Confirm with “enter”:

```
gcloud compute images create nested-ubuntu-noble --source-image-family=ubuntu-2404-lts-amd64 --source-image-project=ubuntu-os-cloud --licenses https://www.googleapis.com/compute/v1/projects/vm-options/global/licenses/enable-vmx
```

```
Welcome to Cloud Shell! Type "help" to get started, or type "gcpcli" to try prompting with Gemini CLI.
Your Cloud Platform project in this session is set to eve-dev-500019.
Use "gcloud config set project [PROJECT ID]" to change to a different project.
uid@dockercloudshell:~$ (eve-dev-500019) gcloud compute images create nested-ubuntu-noble --source-image-family=ubuntu-2404-lts-amd64 --source-image-project=ubuntu-os-cloud --license https://www.googleapis.com/compute/v1/projects/9wq0t0nq/global/licenses/enable-vm
```

If it will ask enable API, answer **Y**. You will get the following output when your image is ready:

```
Cloud Shell Terminal (eve-dev-500019) x + *
Welcome to Cloud Shell! Type "help" to get started, or type "gcpcli" to try prompting with Gemini CLI.
Your Cloud Platform project in this session is set to eve-dev-500019.
Use "gcloud config set project [PROJECT ID]" to change to a different project.
uid@dockercloudshell:~$ (eve-dev-500019) gcloud compute images create nested-ubuntu-noble --source-image-family=ubuntu-2404-lts-amd64 --source-image-project=ubuntu-os-cloud --license https://www.googleapis.com/compute/v1/projects/9wq0t0nq/global/licenses/enable-vm
[compute.googleapis.com] not enabled on project [eve-dev-500019]. Would you like to enable and retry (this will take a few minutes)? (y/N) ? y
Enabling service [compute.googleapis.com] on project [eve-dev-500019]...
Operation [operations/acf.p2-1090659171390-30b484cc-0463-44f3-9c7c-6ebac112720*] finished successfully.
Created [https://www.googleapis.com/compute/v1/projects/eve-dev-500019/global/images/nested-ubuntu-noble].
NAME: nested-ubuntu-noble
PROJECT: eve-dev-500019
FAMILY:
UNDELETED:
STATUS: READY
uid@dockercloudshell:~$ (eve-dev-500019)
```

3.6.3 Creating VM

Step 1: Navigate: Navigation Menu/Compute Engine/VM Instances and press “CREATE INSTANCE”

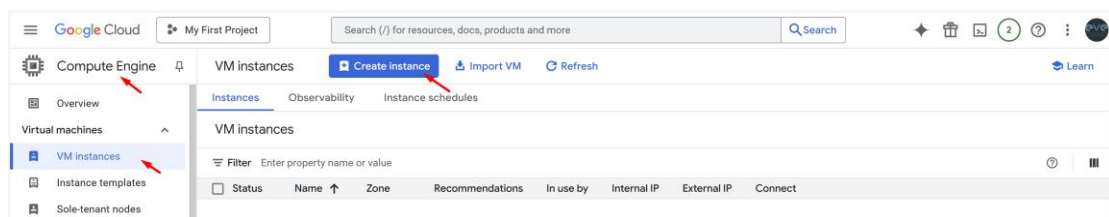
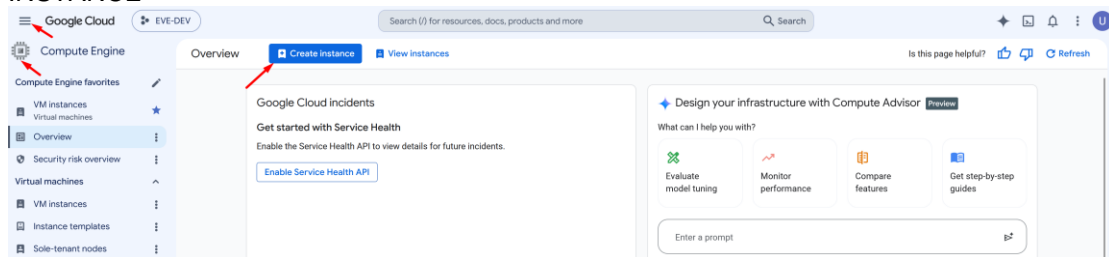

Step 2: Assign the name for your VM

Step 3: Set your own region and zone

Step 4: Edit your **Machine Configuration**. General-Purpose. Choose the series of CPU platform, Preferred are **Intel CPU Cascade Lake. Series N2 CPU**

← Create an instance ✦ Create VM from...

- Machine configuration
n2-standard-8, europe-west2-a
- OS and storage
Debian GNU/Linux 12 (bookworm)
- Data protection
Snapshot schedules
- Networking
1 network interface
- Observability
Install Ops Agent
- Security
- Advanced

Machine configuration

Name *

Region * Zone *

Region is permanent Zone is permanent

General purpose Compute-optimised Memory-optimised Storage optimised GPUs

Machine types for common workloads, optimised for cost and flexibility

Series	Description	vCPUs	Memory	CPU Platform
<input type="radio"/> C4	Consistently high performance	2 - 192	4 - 1,488 GB	Intel Emerald
<input type="radio"/> C4A	Arm-based consistently high performance	1 - 72	2 - 576 GB	Google Axion
<input type="radio"/> C4D	Preview Consistently high performance	2 - 384	3 - 3,024 GB	AMD Turin
<input type="radio"/> N4	Flexible and cost-optimised	2 - 80	4 - 640 GB	Intel Emerald
<input type="radio"/> C3	Consistently high performance	4 - 192	8 - 1,536 GB	Intel Sapphire
<input type="radio"/> C3D	Consistently high performance	4 - 360	8 - 2,880 GB	AMD Genoa
<input type="radio"/> E2	Low-cost day-to-day computing	0.25 - 32	1 - 128 GB	Intel Broadwe
<input checked="" type="radio"/> N2	Balanced price and performance	2 - 128	2 - 864 GB	Intel Cascade

Step 5: Choose Machine Type your desirable CPU and RAM settings.

Machine type

Choose a machine type with preset amounts of vCPUs and memory that suit most workloads. Or, you can create a custom machine for your workload's particular needs. [Learn more](#)

vCPU

8 (4 cores)

Memory

32 GB

Step 6: Edit your OS and Storage configuration. Press Change

- Machine configuration
n2-standard-8, europe-west2-a
- OS and storage
Debian GNU/Linux 12 (bookworm)
- Data protection
Snapshot schedules

Operating system and storage

Name	eve-v6
Type	New balanced persistent disk
Size	10 GB
Snapshot schedule	default-schedule-1
Licence type	Free
Image	Debian GNU/Linux 12 (bookworm)

Step 7. **IMPORTANT** Select Custom images, select OS nested-ubuntu-noble **you created previously**. Choose Boot Disk type: HDD disk type and size. HDD size can vary depends of your needs.

Boot disk

Select an image or snapshot to create a boot disk, or attach an existing disk. Can't find what you're looking for? Explore hundreds of VM solutions in [Marketplace](#)

Public images **Custom images** Snapshots Archive snapshots Existing disks

Source project for images *
eve-dev-500019 Change

Show deprecated images

Image *
nested-ubuntu-noble x86_64

Boot disk type *
SSD persistent disk

[Compare disk types](#)

Size (GB) *
100
Provision between 10 and 65536 GB

[Show advanced configuration](#)

Select Cancel

Step 8: Edit your Data Protection, select No backups.

- OS and storage
nested-ubuntu-jammy
- Data protection**
No backups
- Networking
1 firewall rule, 1 network interface
- Observability

Back up your data

You can automate recurring backups through a backup plan or snapshot schedule. [Learn more](#)

Backup plan
Back up the full VM. These immutable backups are secured by backup vault against accidental or malicious deletion. Managed by Backup and DR Service, a separate service from Compute Engine with independent certifications and accreditation. [Learn more](#)

Snapshot schedules
Back up disks only. This provides foundational protection at a lower cost. [Learn more](#)

No backups Neither VM nor disks will be backed up. If data is deleted or corrupted for any reason, you won't be able to recover it.

Step 9: Edit your Networking Allow https traffic.

- Machine configuration
n2-standard-8, europe-west2-a
- OS and storage
nested-ubuntu-jammy
- Data protection
No backups
- Networking**
1 firewall rule, 1 network interface
- Observability
Install Ops Agent

Networking

Firewall

Add tags and firewall rules to allow specific network traffic from the Internet

Allow HTTP traffic

Allow HTTPS traffic

Allow load balancer health checks

Network tags ?

Hostname ?
Set a custom hostname for this instance or leave it default. Choice is permanent

Step 10: Edit Security and Disable Secure Boot and vTPM

- OS and storage
nested-ubuntu-jammy
- Data protection
No backups
- Networking
1 firewall rule, 1 network interface
- Observability
Install Ops Agent
- Security**

Confidential VM service

Confidential Computing is disabled on this VM instance

[Enable](#)

Shielded VM

Turn on all settings for the most secure configuration.

Turn on Secure Boot

Turn on vTPM

Turn on integrity monitoring

VM access
Manage how users connect to the VM

Step 10: (Optional), Skip this step if your EVE VM will not a part of EVE-NG Cluster.
Before to select MTU1500 network please follow steps how to create it [3.6.7](#)
Select Networking/Network Interfaces.
Edit network interface and select created network: **MTU1500**

Network interfaces ?

Network interface is permanent

Edit network interface 🗑️ ⬆️

Network * ▼ ?

Subnetwork * ▼ ?

Step 11: [Create VM](#).

3.6.4 EVE-NG Pro installation

Step 1: Click VM Instances to get access SSH to your VM, Connect to the VM with the first option “Open in browser window”

Filter VM instances Columns ▼

Name	Zone	Recommendation	In use by	Internal IP	External IP	Connect
<input checked="" type="checkbox"/> eve-1	europa-west-2-c			10.154.0.3 (nic0)	35.189.102.127 ↗	SSH ▼ ⋮

- Open in browser window
- Open in browser window on custom port
- Open in browser window using provided private SSH key
- View gcloud command
- Use another SSH client

Related Actions

SSH-in-browser 📄 UPLOAD FILE 📄 DOWNLOAD FILE 🗑️ ⌨️ ⚙️

```

Welcome to Ubuntu 24.04.4 LTS (GNU/Linux 6.17.0-1018-gcp x86_64)

 * Documentation:  https://help.ubuntu.com
 * Management:    https://landscape.canonical.com
 * Support:       https://ubuntu.com/pro

System information as of Sat Jun 20 19:30:54 UTC 2026

System load:  0.47          Processes:    175
Usage of /:   3.0% of 95.82GB Users logged in:  0
Memory usage: 2%          IPv4 address for ens4: 10.154.0.2
Swap usage:   0%

Expanded Security Maintenance for Applications is not enabled.

8 updates can be applied immediately.
8 of these updates are standard security updates.
To see these additional updates run: apt list --upgradable

Enable ESM Apps to receive additional future security updates.
See https://ubuntu.com/esm or run: sudo pro status

The programs included with the Ubuntu system are free software;
the exact distribution terms for each program are described in the
individual files in /usr/share/doc/*/copyright.

Ubuntu comes with ABSOLUTELY NO WARRANTY, to the extent permitted by
applicable law.

uldis_dzercals@eve-v7:~$
```

Step 2: Launch installation with:

Type the below command to become root:

```
sudo -i
```

Start EVE-PRO installation. (Please do commands one by one below)

```
wget https://www.eve-ng.net/noble/install-eve-pro.sh
chmod +x install-eve-pro.sh
./install-eve-pro.sh
```

Step 3: Update and upgrade your new EVE-Pro

```
apt update
```

```
apt upgrade
```

Confirm with Y

Step 4. Reboot EVE. Allow some time for reboot and then press "Reconnect"

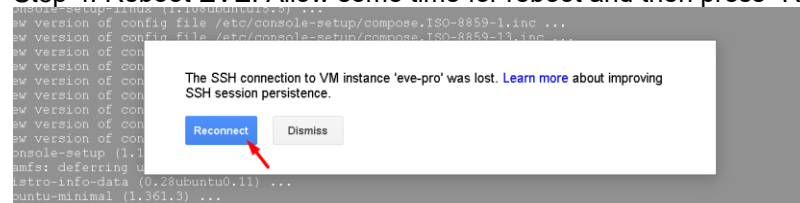

Step 5: **IMPORTANT:** Setup IP

Once the IP wizard screen appears, press **ctrl + c** and type the below command to become **root**:

```
sudo -i
```

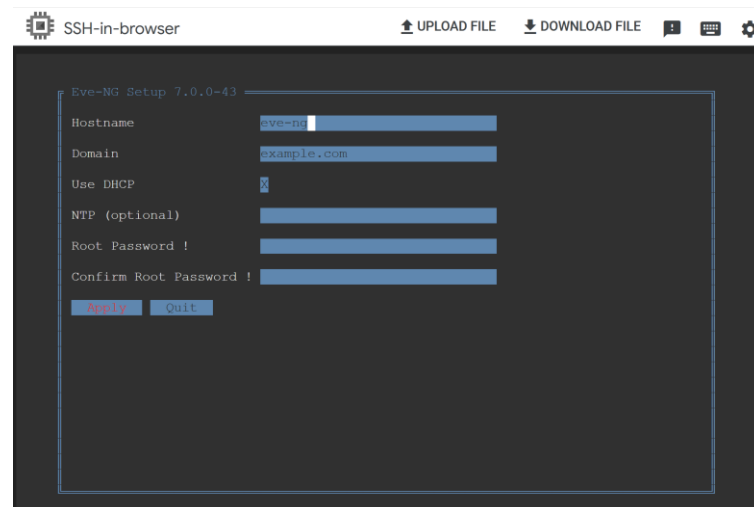

Now follow the IP setup wizard.

IMPORTANT: set IP as **DHCP!**

Step 6: Reboot

Step 7: Dockers installation. After EVE is rebooted, reconnect the SSH session:

Type command to become root:

```
sudo -i
```

Type command to update EVE

```
apt update
```

Type command to Install Dockers

```
apt install eve-ng-dockers
```

```
root@eve-ng:~# dc images
REPOSITORY TAG IMAGE ID CREATED SIZE
eve-desktop latest ca119c21bd7 12 hours ago 3.65GB
eve-gui-server latest 9db19c879a17 2 days ago 3.64GB
eve-firefox latest 0266109a1bb 7 weeks ago 2.12GB
eve-mysql latest 82e009773e93 7 weeks ago 1.56GB
root@eve-ng:~#
```

3.6.5 Access to Google Cloud EVE-PRO

Use your public IP for accessing EVE via https.

Name	Zone	Recommendation	In use by	Internal IP	External IP	Connect
<input checked="" type="checkbox"/> eve-pro	europe-west2-c			10.154.0.2 (nic0)	<u>35.246.119.90</u>	SSH

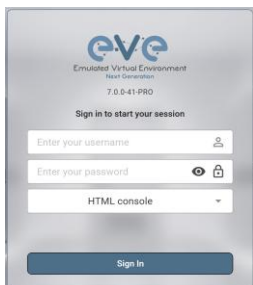

Default web login: **admin/eve**

Note: It is strongly recommended that you will change admin password on GUI! Do not delete default admin user account!

3.6.6 Optional: GCP MTU 1460 Firewall rules for native console use

NOTE: If your GCP VM is using default network (MTU1460), then for native console use, you have to create following FW rules.

Open the google cloud shell and press: "Activate Cloud Shell"

Copy the following commands in SHELL Cloud console:

```
##### Create default network (MTU 1460) Firewall rules for native console use #####

gcloud compute firewall-rules create eve-all-out --direction=EGRESS --priority=1000 --network=default --action=ALLOW --rules=tcp:0-65535 --destination-ranges=0.0.0.0/0

gcloud compute firewall-rules create eve-all-in --direction=INGRESS --priority=1000 --network=default --action=ALLOW --rules=tcp:0-65535 --destination-ranges=0.0.0.0/0
```

Firewall rules summary:

Name	Type	Targets	Filters	Protocols/ports	Action	Priority	Network	Logs
<input checked="" type="checkbox"/> eve-all-out	Egress	Apply to all	IP	tcp:0-65535	Allow	1000	default	Off
<input checked="" type="checkbox"/> eve-all-in	Ingress	Apply to all	IP	tcp:0-65535	Allow	1000	default	Off

3.6.7 Optional: Network MTU 1500 settings and firewall rules for GCP

If your GCP VM is expected to be as a part of EVE-NG Cluster system please complete the MTU network settings and firewall rules setup before creating the instance.

⚠ NOTE: GCP VM by default has MTU 1460 set for the interfaces by default. You may require to set VM machine custom MTU (1500) which is commonly known default setting for ethernet. The MTU settings on the GCP interface must be adjusted if you want it to use as the part of EVE-NG cluster system.

Open the google cloud shell and press: Press “Activate Cloud Shell”

Copy the following commands in SHELL Cloud console:

```
##### Create 1500 MTU subnet #####

gcloud compute networks create mtu1500 --subnet-mode=auto --mtu=1500
--bgp-routing-mode=regional

##### Create 1500 MTU firewall rules #####

gcloud compute firewall-rules create wireguard-in --direction=INGRESS
--priority=1000 --network=mtu1500 --action=ALLOW --rules=udp:60569 --
source-ranges=0.0.0.0/0

gcloud compute firewall-rules create wireguard-out --direction=EGRESS
--priority=1000 --network=mtu1500 --action=ALLOW --rules=udp:60569 --
destination-ranges=0.0.0.0/0

gcloud compute firewall-rules create ssh-in --direction=INGRESS --
priority=1000 --network=mtu1500 --action=ALLOW --rules=tcp:22 --
source-ranges=0.0.0.0/0

gcloud compute firewall-rules create ssh-out --direction=EGRESS --
priority=1000 --network=mtu1500 --action=ALLOW --rules=tcp:22 --
destination-ranges=0.0.0.0/0
```

Firewall rules summary:

<input type="checkbox"/>	Name	Type	Targets	Filters	Protocols/ports	Action	Priority	Network ↑	Logs
<input type="checkbox"/>	ssh-out	Egress	Apply to all	IP	tcp:22	Allow	1000	mtu1500	Off
<input type="checkbox"/>	wireguard-out	Egress	Apply to all	IP	udp:60569	Allow	1000	mtu1500	Off
<input type="checkbox"/>	ssh-in	Ingress	Apply to all	IP	tcp:22	Allow	1000	mtu1500	Off
<input type="checkbox"/>	wireguard-in	Ingress	Apply to all	IP	udp:60569	Allow	1000	mtu1500	Off

3.6.8 Optional: GCP MTU 1500 Firewall rules for native console use

Open the google cloud shell and press: Press “Activate Cloud Shell”

Copy the following commands in SHELL Cloud console:

```
##### Create MTU 1500 firewall rules for native console use #####
```

```
gcloud compute firewall-rules create allow-all-in --direction=INGRESS
--priority=1000 --network=mtu1500 --action=ALLOW --rules=tcp:0-65535
--source-ranges=0.0.0.0/0

gcloud compute firewall-rules create allow-all-out --direction=EGRESS
--priority=1000 --network=mtu1500 --action=ALLOW --rules=tcp:0-65535
--destination-ranges=0.0.0.0/0
```

Summary FW rules.

<input type="checkbox"/>	Name	Type	Targets	Filters	Protocols/ports	Action	Priority	Network ↑	Logs
<input type="checkbox"/>	allow-all-out	Egress	Apply to all	IP	tcp:0-65535	Allow	1000	mtu1500	Off
<input type="checkbox"/>	allow-all-in	Ingress	Apply to all	IP	tcp:0-65535	Allow	1000	mtu1500	Off

3.7 Azure Cloud Platform

3.7.1 Azure account

Step 1: Connect to Microsoft Azure Cloud Platform (Azure)

<https://portal.azure.com/>

Step 2: Sign into Azure. Create a new Azure account if you do not already have one.

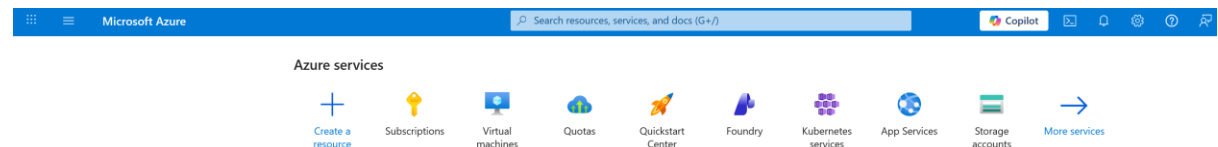

3.7.2 Resource Group

Step 1: Open Resource Manager and create Resource Group if you did not create it already.

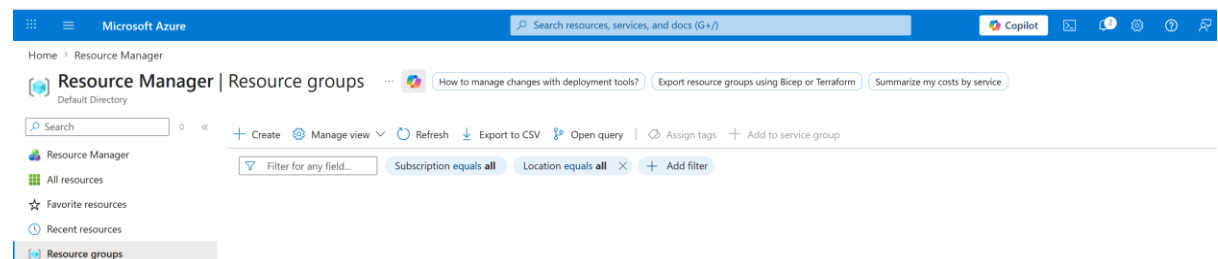

Step 2: Review + Create. Here is important to chose proper Region, because not all regions supporting multi CPU and RAM Virtual machines. (US) East US Region provided virtual machines suitable for EVE-NG installation.

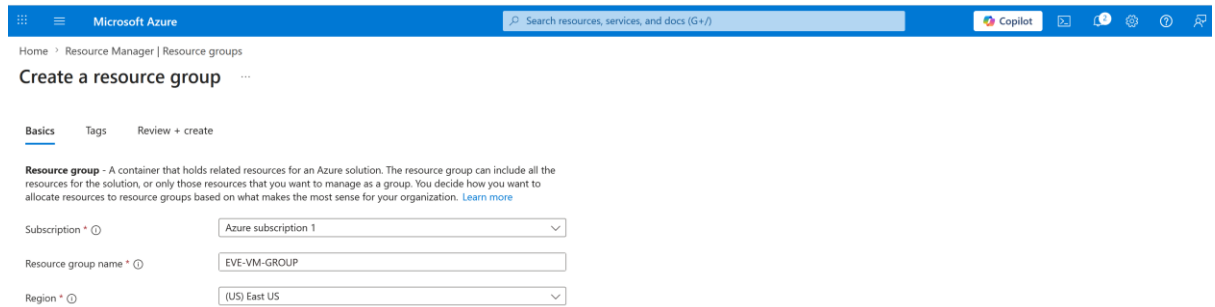

3.7.3 Create Virtual machine

Step 1: Navigate to Compute infrastructure/Virtual machines and Press + Create.

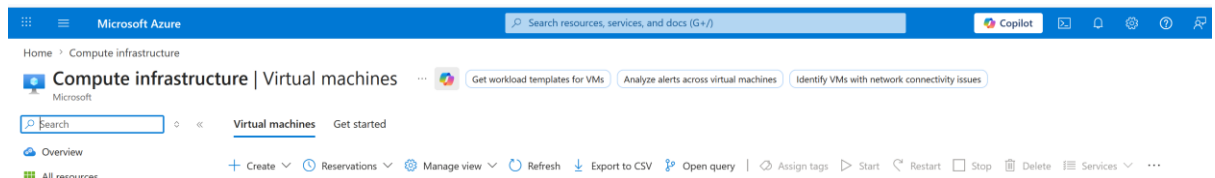

Step 2: Create New Virtual machine.

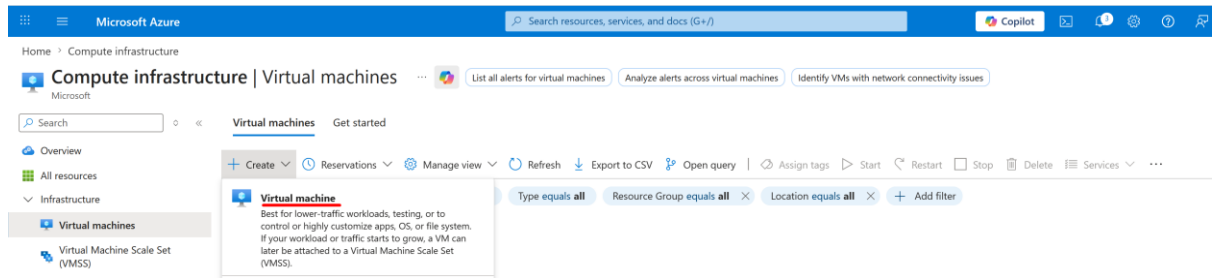

Step 3: Select project details, Subscription and Resource group. Resource group we created earlier.

Project details

Select the subscription to manage deployed resources and costs. Use resource groups like folders to organize and manage all your resources.

Subscription * ⓘ

Resource group * ⓘ

[Create new](#)

Step 4: Select instance details. Virtual machine name. Select Region. Region you can change accordingly your chosen Virtual machine configuration. In this example, I will setup EVE-NG on the x8 CPU and 32 GB RAM machine. Region (Europe) France Central supports such VM.

Instance details

Virtual machine name * ⓘ

Region * ⓘ
[Deploy to an Azure Extended Zone](#)

Availability options ⓘ

Zone options ⓘ

Self-selected zone
Choose up to 3 availability zones, one VM per zone

Azure-selected zone (Preview)
Let Azure assign the best zone for your needs

Availability zone * ⓘ

You can now select multiple zones. Selecting multiple zones will create one VM per zone. [Learn more](#)

Step 5: Select Trusted launch virtual machine. Press Configure security features, and de-select TPM and Secure boot options.
Select Image: Ubuntu 24.04 LTS. VM Architecture: x64.
Select desirable VM size. (This example VM is x8 CPU and 32GB RAM).

Security type ⓘ
[Configure security features](#)

Image * ⓘ
[See all images](#) | [Configure VM generation](#)

VM architecture ⓘ

Arm64

x64

Run with Azure Spot discount ⓘ

Size * ⓘ
[See all sizes](#) | [Customize cores](#)

Enable Hibernation ⓘ

Hibernation does not currently support Trusted launch and Confidential virtual machines for Linux images. [Learn more](#)

Configure security features

Enable secure boot ⓘ

Enable vTPM ⓘ

Integrity monitoring ⓘ

Step 6: Configure Administrator Account. Select Account type: Password.
Assign your VM machine username and password.

Administrator account

Authentication type ⓘ

SSH public key

Password

Username * ⓘ

Password *

Confirm password *

Step 7: Configure Inbound Port rules. Select SSH and HTTPS.

Inbound port rules

Select which virtual machine network ports are accessible from the public internet. You can specify more limited or granular network access on the Networking tab.

Public inbound ports * ⓘ None
 Allow selected ports

Select inbound ports *

- HTTP (80)
- HTTPS (443)
- SSH (22)

Step 8: Press Tab Next : Disks >. Select desirable VM OS Disk size and OS Disk type. In this example OS disk size is 128GB and type SSD. Data disk is not required.

Azure disk storage encryption automatically encrypts your data stored on Azure managed disks (OS and data disks) at rest by default when persisting it to the cloud.

Encryption at host ⓘ

i Encryption at host is not registered for the selected subscription. [Learn more](#) ↗

OS disk

OS disk size ⓘ

i Some images are, by default, smaller than the selected OS disk size. [Click here to learn how to expand your disk partition size after you create your VM.](#) ↗

OS disk type * ⓘ

Delete with VM ⓘ

Key management ⓘ

Enable Ultra Disk compatibility ⓘ

Data disks for EVE-V7

You can add and configure additional data disks for your virtual machine or attach existing disks. This VM also comes with a temporary disk.

LUN	Name	Size (GiB)	Disk type	Host caching	Delete with VM ⓘ
Create and attach a new disk Attach an existing disk					

Step 8: Press Tab Next : Networking >. Leave default settings for Networking

Network interface

When creating a virtual machine, a network interface will be created for you.

Virtual network * ⓘ (new) EVE-V7-vnet
[Create new](#)

Subnet * ⓘ (new) default (10.0.0.0/24)

Public IP ⓘ (new) EVE-V7-ip
[Create new](#)
i Public IP addresses have a nominal charge. [Estimate price](#)

NIC network security group ⓘ
 None
 Basic
 Advanced

Public inbound ports * ⓘ
 None
 Allow selected ports

Select inbound ports * (HTTPS (443), SSH (22))

⚠ This will allow all IP addresses to access your virtual machine. This is only recommended for testing. Use the Advanced controls in the Networking tab to create rules to limit inbound traffic to known IP addresses.

Delete public IP and NIC when VM is deleted ⓘ

Enable accelerated networking ⓘ

Load balancing

You can place this virtual machine in the backend pool of an existing Azure load balancing solution. [Learn more](#)

Load balancing options ⓘ
 None
 Azure load balancer
Supports all TCP/UDP network traffic, port-forwarding, and outbound flows.

Step 9: Press Tab Next: Management >. Leave default settings for Management

Step 10: Press Tab Next: Monitoring >. Leave default settings for Monitoring

Step 11: Press Tab Next: Advanced >. Leave default settings for Advanced

Step 12: Press Tab Next : Tags >. Leave default settings for Tags

Step 13: Press Review and Create. Press Create

Step 14: Press: Go to resource

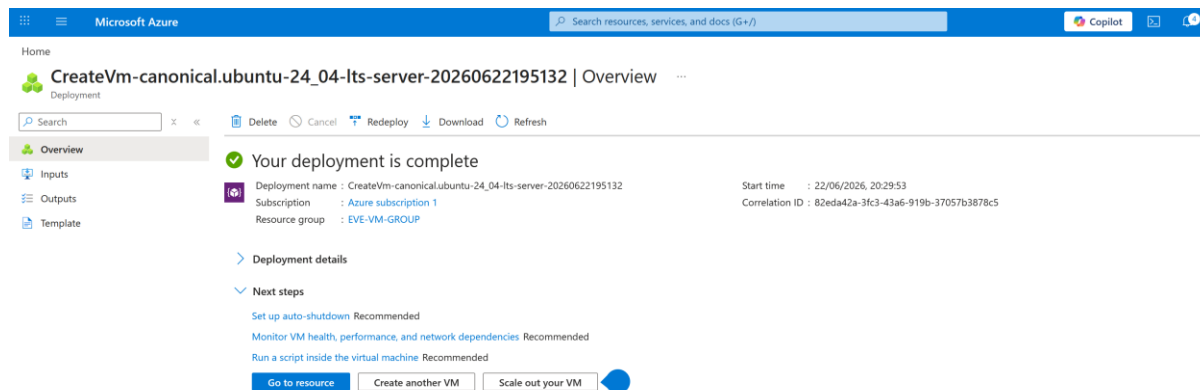

3.7.4 EVE-NG Software installation.

Step 1: Navigate: Connect / More ways to connect (4) Click “Go to serial console”

Step 2: Use your created username and password to connect to your Virtual machine.

```
Ubuntu 24.04.4 LTS EVE-V7 ttyS0
EVE-V7 login: eveuser
Password:
```

Once you have connected to your VM, setup your root password.

```
eveuser@EVE-V7:~$ sudo -i
root@EVE-V7:~# passwd root
New password:
Retype new password:
passwd: password updated successfully
root@EVE-V7:~#
```

Step 3: Launch EVE-NG installation commands:

```
sudo -i
```

Start EVE-PRO installation. (Please do commands one by one below)

```
wget https://www.eve-ng.net/noble/install-eve-pro.sh
chmod +x install-eve-pro.sh
./install-eve-pro.sh
```

Step 4: Once installation is completed, you will see such IP setup window:

```
Eve-NG Setup 7.0.0-48
-----
Hostname          eve-ng
Domain            example.com
Use DHCP          [X]
NTP (optional)
Root Password !
Confirm Root Password !
Apply  Quit
```

IMPORTANT: Use DHCP IP selected and set your EVE-NG root password. Apply changes. EVE-NG VM will auto reboot.

Step 5: Update and upgrade your new EVE-Pro

```
apt update
```

```
apt upgrade
```

Confirm with Y

Step 6: Reboot

Step 7: Dockers installation. After EVE is rebooted, reconnect the SSH session:

Type command to become root:

```
sudo -i
```

Type command to update EVE

```
apt update
```

Type command to Install Dockers

```
apt install eve-ng-dockers
```

```
root@eve-ng:~# dc images
REPOSITORY      TAG          IMAGE ID      CREATED      SIZE
eve-desktop     latest      ca1338621bd7  12 hours ago 3.65GB
eve-sui-server  latest      8ab19c879a17  2 days ago   3.84GB
eve-firefox     latest      0266d1061bb  7 weeks ago  2.12GB
eve-mirshark    latest      82a009773e89  7 weeks ago  1.56GB
root@eve-ng:~#
```

3.7.5 Access to Azure Cloud EVE-PRO

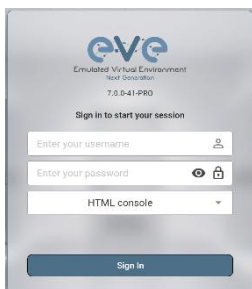

Use your public IP for accessing EVE via https. Default web login: **admin/eve**

Note: It is strongly recommended that you will change admin password on GUI! Do not delete default admin user account!

3.8 EVE Management IP Address setup

⚠ NOTE: Please make sure if these subnets are NOT used in your network outside of EVE.

172.29.129.0/24 (NAT Interface)

172.29.130.0/24 (Cluster VPN subnet, wg0 interface)

172.17.0.0/16 (Dockers consoles)

⚠ To change these networks please refer chapter **7.4.1**

3.8.1 Static Management IP address setup (preferred)

⚠ IMPORTANT NOTE: Internet and DNS must be reachable from your Server. The EVE-NG Pro requires internet access to get updates and validate EVE-NG Pro License key. DNS must resolve names!

The steps below will walk you through the network setup and assign a static management IP for EVE.

Step 1: Log into the EVE CLI using the default login **root/eve** After login, your EVE-NG machine will direct you to the IP setup wizard.

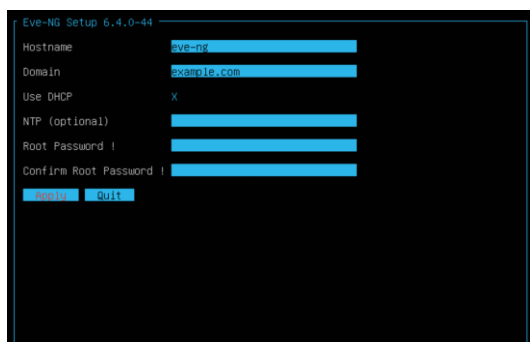

Step 2: Use tab key to select necessary options.

Hostname: Set the name for your EVE-NG machine. Default is: eve-ng

Domain: Set your desired domain name. Default is: example.com

Step 3: If DHCP is **de-selected**, your IP setup will continue with **static IP settings**.

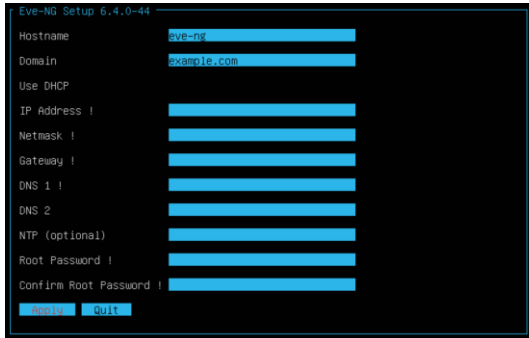

Step 4: Use tab key to set or edit necessary options.

Hostname: Set the name for your EVE-NG machine. Default is: eve-ng

Domain: Set your desired domain name. Default is: example.com

Use DHCP: Option is **de-selected**. Select or deselect this option use space bar key.

IP Address: Set your EVE-NG machine IP address.

Netmask: Set your EVE-NG machine network subnet mask.

Gateway: Set your EVE-NG machine gateway IP.

DNS1: Set your first DNS IP.

DNS2: Set your second DNS IP.

NTP (optional): you can set your desirable NTP server IP.

Root Password: Your EVE-NG system cli root password

Confirm Root Password: Repeat your cli root password.

Apply. Your system will reboot and your set IP address will be used to access your EVE-NG https interface. HTTPS GUI default login is: **admin/eve**

Example: Static IP settings:

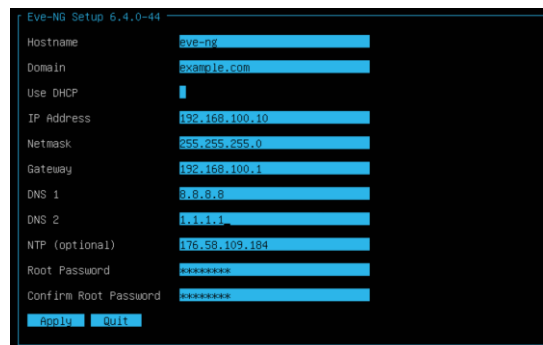

3.8.2 DHCP Management IP address setup

! IMPORTANT NOTE: Internet and DNS must be reachable from your Server. The EVE-NG Pro requires internet access to get updates and validate EVE-NG Pro License key. DNS must resolve names!

! IMPORTANT NOTE: EVE Docker stations for html console access are using network 172.17.0.0/16. Please avoid use this network on the EVE management or other clouds or interfaces.

The steps below will walk you through the network setup and assign a management IP for EVE via DHCP.

Step 1: Log into the EVE CLI using the default login **root/eve**. After login, your EVE-NG machine will direct you to the IP setup wizard.

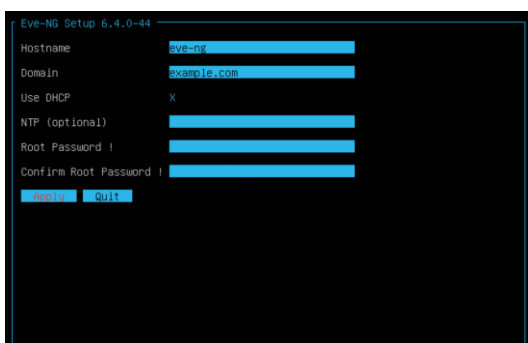

Step 2: Use tab key to select necessary options.

Hostname: Set the name for your EVE-NG machine. Default is: eve-ng

Domain: Set your desired domain name. Default is: example.com

Use DHCP: Select or deselect this option use space bar key.

DHCP is **selected X**, your IP setup will continue with **DHCP IP settings**.

NTP (optional): you can set your desirable NTP server IP

Root Password: Your EVE-NG system cli root password

Confirm Root Password: repeat your root password.

Apply. Your system will reboot and your set IP address will be used to access your EVE-NG https interface. HTTPS GUI default login is: **admin/eve**

Example: DHCP IP settings:

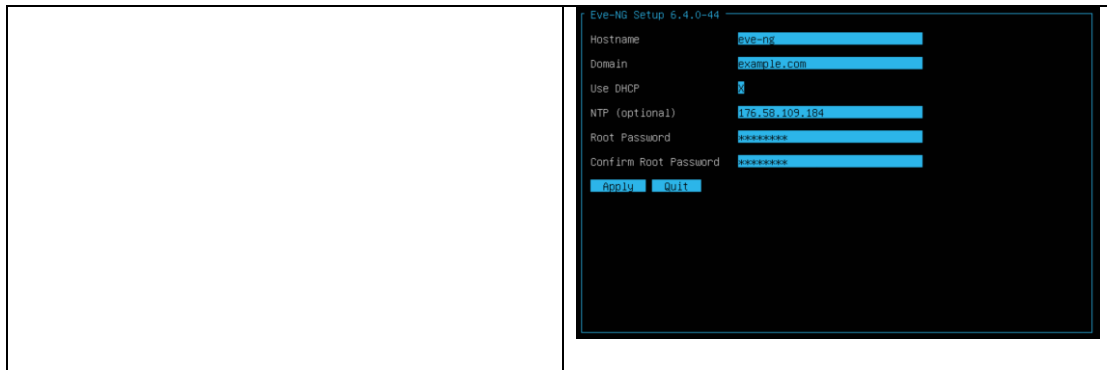

3.8.3 Internet proxy setup

Step 1: If you have a proxy in use for your Internet, login into your EVE WEB GUI using your EVE IP <https://aaa.aaa.aaa.aaa>

Default username: **admin**

Password: **eve**

Step 2: Select Tab: System/System Settings

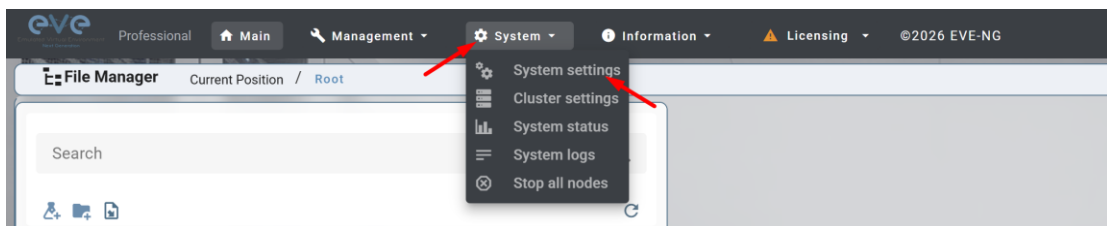

Step 3: Enter your Proxy IP and Port following by "Apply". For authenticated Proxy, use your username and password.

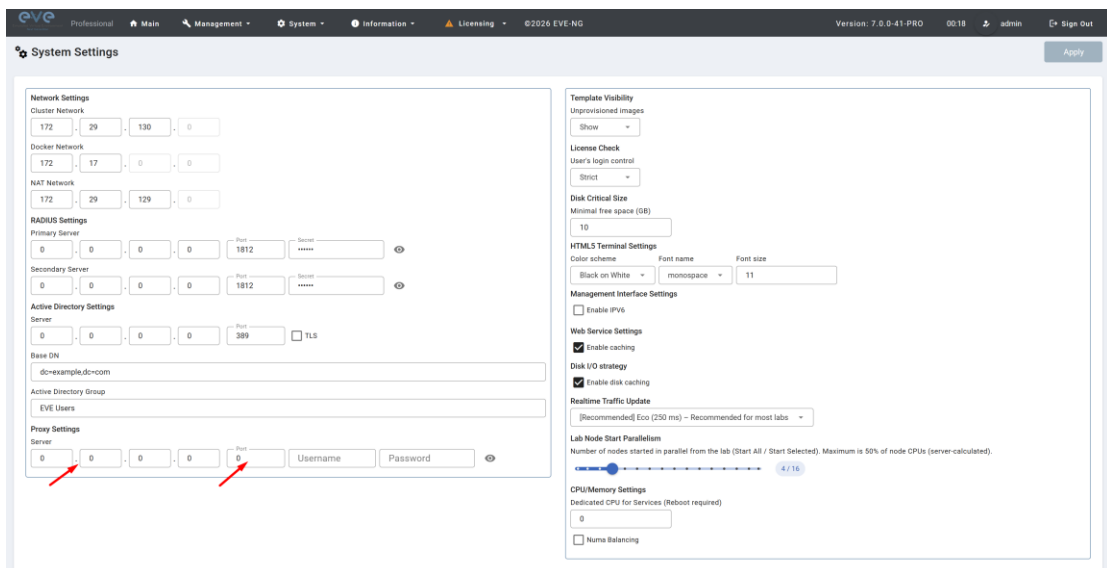

3.8.4 Reset Management IP settings

If for any reason you need to change these settings after the installation, you can rerun the IP setup wizard. Type the following command in the CLI and hit enter:

```
rm -f /opt/ovf/.configured
```

Then type:

```
su -
```

Once you log into the CLI again, EVE will go through the network setup again. Please follow the steps in section 3.8.1 for Static IP or 3.8.2 for DHCP IP.

3.9 Native console management setup

If you prefer to use a natively installed Telnet, VNC and Wireshark client to manage nodes inside EVE. Download from Main/Information/Client Downloads your preferable Client pack and follow the steps below:

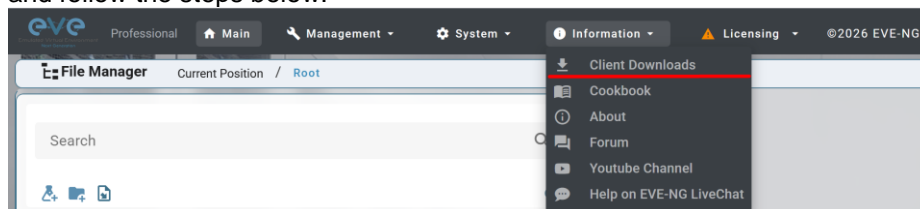

3.9.1 Windows Native Console

Step 1: Your host system will be detected automatically and will be provided recommended pack to download, Windows, MAC OS or Linux Client packs.

Client Downloads

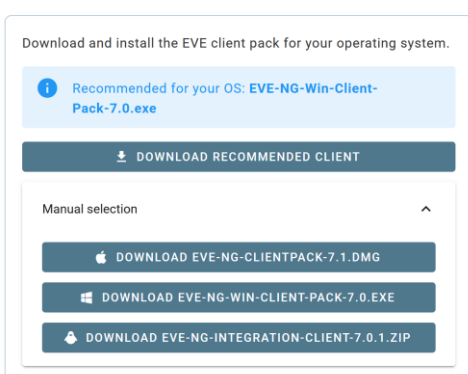

Step 2: Run Downloaded Client pack and install it as administrator. Windows pack option.

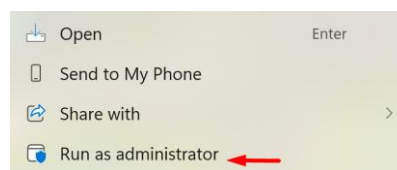

Step 3: Leave the option for UltraVNC checked. UltraVNC is very tiny and the

Step 4: Continue with Next. When it asks to choose Ultra VNC Options, only leave the

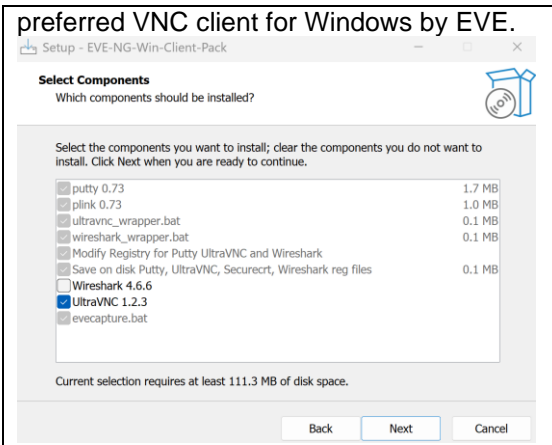

preferred VNC client for Windows by EVE.

NOTE: The Native Wireshark option for EVE Professional is left unchecked, Wireshark newest version you can install by yourself downloading Wireshark from official site.

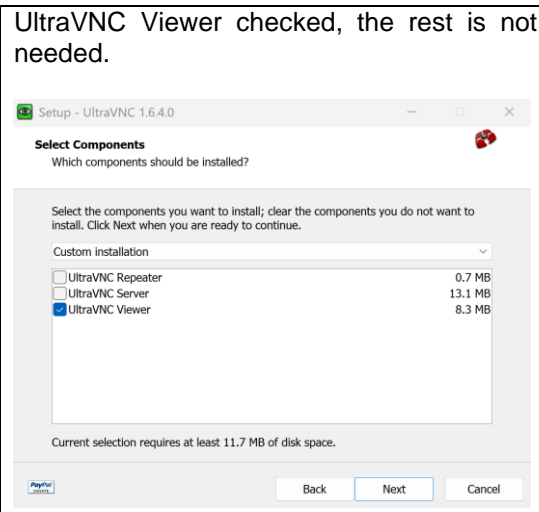

UltraVNC Viewer checked, the rest is not needed.

Step 5: Continue with Next and finish the installation.

By default, EVE Windows Client Integration will install **Putty** as your Telnet Client. The default location for the EVE Windows Client Integration software and .reg files is: "C:\Program Files\EVE-NG"

Set the default telnet program manually in Windows 11. Example: Secure CRT

Step 1: Go to: Windows Settings/Apps/Default Apps/Choose Default Apps by Protocol

Step 2: Set your default Telnet program:

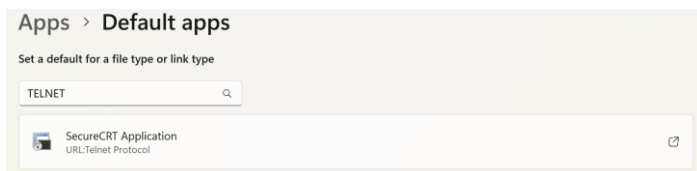

NOTE: The first time click on the type of link that is used to access a running node inside EVE via telnet, the browser will ask to choose the telnet program. If you have prepared your default telnet program with the instructions above, you have to choose your default Telnet program.

Example: Firefox browser: Set your default application, check the box "Remember my choice telnet links" and click Open link

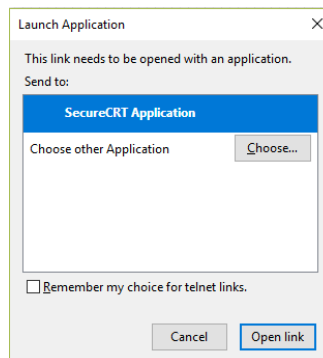

3.9.2 Linux Native Console

The steps below will show how to setup the native consoles pack for Linux:

<p>Step 1: Download Linux Client integration pack:</p> <p>DOWNLOAD EVE-NG-INTEGRATION-CLIENT-7.0.1.ZIP</p>	<p>Step 2: Unzip Linux pack, make install file executable.</p> <pre>chmod +x eve-ng-integration-client-7.0.1.run</pre> <p>Step 3: Once Linux Client pack program is executable, run Installation by GUI.</p>
--	--

3.9.3 MAC OSX Native Console

[DOWNLOAD EVE-NG-CLIENTPACK-7.1.DMG](#)

Download the EVE MAC OSX Client integration pack .DMG and install it:

3.10 Login to the EVE WEB GUI

EVE PRO is using https 443. Login to the EVE management UI:

https://<your_eve_ip>/

Default user access: **User: admin Password: eve**

- ⚠ NOTE: You can change your EVE Admin password, please refer to section **7.3.1.2**
- ⚠ **IMPORTANT NOTE:** You must prepare and upload at least a couple of images to start building your labs. Refer to section **18**

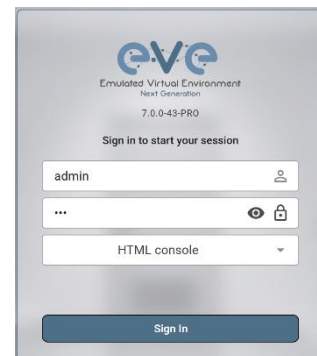

4 EVE-NG Professional Licensing

⚠ IMPORTANT NOTE: Internet and DNS must be reachable from your Server. The EVE-NG Pro requires internet access to get updates and validate EVE-NG Pro License key. DNS must resolve names!

EVE-NG Professional and Learning Centre editions require purchasing and uploading a license to activate its features. Licenses are based on an annual subscription.

EVE-NG permits up to **32000 accounts** to be created but restricts the number of simultaneous sessions per role to the licensed amount. To increase the number of active sessions, please purchase additional licenses on top of the base license as shown below.

⚠ Definition: Simultaneous session (1 license) means one active connection to the EVE-NG Web GUI.

License Details

📅 Expiration Date:	Unlicensed
👤 Admin Users:	2
👤 Editor Users:	0
👤 Regular Users:	0

Close

Freemium EVE-Professional: The license information page shows Unlicensed expiration date and 2 Admin accounts. This means 2 Admin users' role-based accounts (2) can be logged into the Web GUI simultaneously. EVE-NG PRO can have up to 32K accounts, but active sessions to the Web GUI are restricted to the number of purchased licenses. Freemium license allows to run up to **7 nodes** per EVE instance.

License Details

📅 Validity:	from 21 Jun 2026 to 22 Jun 2027
👤 Admin Users:	2
👤 Editor Users:	0
👤 Regular Users:	0

Close

EVE-Professional: The license information page shows 2 Admin accounts. This means 2 Admin users' role-based accounts (2) can be logged into the Web GUI simultaneously. EVE-NG PRO can have up to 32K accounts, but active sessions to the Web GUI are restricted to the number of purchased licenses.

License Details

📅 Validity:	from 21 Jun 2026 to 22 Jun 2027
👤 Admin Users:	2
👤 Editor Users:	3
👤 Regular Users:	3

Close

EVE Learning Centre: The license information page shows 2 Admin, 3 Editor and 3 Lab user role accounts. This means 2 Admin, 3 Editor and 3 User accounts can be logged into the Web GUI simultaneously. EVE-NG Learning Center can have up to 32K accounts, but active sessions to the Web GUI are restricted by the number of licenses purchased.

4.1 EVE-NG Professional Base license

EVE-NG Professional Edition - 1 Year License
<https://www.eve-ng.net/index.php/buy/>

EVE-NG PRO features multi user support and assigns all accounts as Administrators. The license allows for 2 simultaneous users. Screenshot below is for informational purposes only. Actual price can vary depending of currency rates.

Products in your shopping cart

✕	<p>EVE-NG Professional Edition - 1 Year License</p> <p>EVE-NG Professional Edition - 1 Year License This license unlocks all Pro features and two active Administrator accounts sessions. The Administrator role can manage everything in EVE-NG without restriction. This includes creating, deleting, and modifying all folders, labs, nodes and accounts.</p>	1	\$109.66
---	---	---	----------

I have a discount coupon

Total price: \$131.59

Total TAX/VAT (20%) : \$21.93

For EVE-PRO Administrator role permissions, please see section 4.4.

4.2 EVE-NG Learning Centre licenses

EVE-NG Learning Centre Edition - 1 Year License

<https://www.eve-ng.net/index.php/buy-corporate/>

EVE-NG LC features multi user support and assigns accounts as Administrators, Lab-Editors or Lab-Users.

The first minimal Base A license allows for 2 simultaneous Admin users. It is necessary to use an Administrator account to create or manage EVE LC and other user's role-based accounts.

	<p>EVE-NG Professional Base - 1 Year License</p> <p>This license unlocks all Pro features and two active Administrator accounts sessions.</p> <p>EVE-PRO allows up to 128 accounts to be created but restricts the number of active sessions, per role, to the licensed amount. To increase the number of simultaneous account sessions, please purchase additional licenses below.</p>	<p>1</p> <p>Minimum Mandatory Base license</p>	<p>99,00 €</p>
<p>Optional Licenses</p>		<p>Change quantity</p>	<p>Remove from order if no need this option</p>
	<p>EVE-NG PRO Administrator - 1 Year License</p> <p>This license unlocks one additional active session for the Administrator role.</p> <p>The Administrator role can manage everything in EVE-NG without restriction.</p> <p>This includes creating, deleting, and modifying all folders, labs, nodes and accounts.</p> <p>The Administrator is the only role that can create or modify accounts.</p>	<p>- 1 +</p>	<p>99,00 € </p>
	<p>EVE-NG PRO Lab Editor - 1 Year License</p> <p>This license unlocks one additional active session for the Editor role.</p> <p>The Editor role is restricted to a personal folder and is authorized to create, delete, or modify additional folders, labs, and nodes within it.</p>	<p>- 1 +</p>	<p>350,00 € </p>
	<p>EVE-NG PRO Lab User - 1 Year License</p> <p>This license unlocks one additional active session for the User role.</p> <p>The User role is restricted to a personal folder and is only authorized to start, stop, and wipe nodes. An Administrator account is required to manage folders and labs within a Users folder.</p>	<p>- 1 +</p>	<p>300,00 € </p>

EVE-NG PRO – A Base License (Mandatory)

This license unlocks all Pro features and two active Administrator accounts sessions. This license is mandatory for EVE LC edition.

The following licenses below can vary per your needs.

EVE-NG PRO - Administrator License

This license unlocks one additional active session for the Administrator role. The Administrator role can manage everything in EVE-NG without restrictions. This includes creating, deleting, and modifying all folders, labs, nodes and accounts. The Administrator is the only role that can create or modify accounts.

EVE-NG PRO – Lab-Editor License

This license unlocks one additional active session for the Lab-Editor role. The Lab-Editor role is restricted to a personal and the Shared folder and is authorized to create, delete, or modify additional folders, labs, and nodes within them.

EVE-NG PRO – Lab-User License



This license unlocks one additional active session for the Lab-User role.

The Lab-User role is restricted to a personal and the Shared folder and is only authorized to start, stop, and wipe nodes. An Administrator account is required to manage folders and labs within a User's personal folder.

Example: EVE Learning Centre Licensing for 1 Teacher and a 5 Students class.

Licence model below includes:

- Two administrator accounts, necessary for EVE LC labs and other user account management
- One Lab-Editor-role based account, assigned to the teacher to create/manage labs and assign them to the Shared folder for Students use. The Lab-Editor role is restricted to a personal folder and is authorized to create, delete, or modify additional folders, labs, and nodes within it.
Optional: If wanted / needed, the Lab-Editor account for the teacher can also be replaced by an Administrator account instead.
- Five Lab-User role-based Student accounts allowing running a class with 5 simultaneous students connected to the EVE HTML GUI.

	<p>EVE-NG Professional Base - 1 Year License This license unlocks all Pro features and two active Administrator accounts sessions. EVE-PRO allows up to 128 accounts to be created but restricts the number of active sessions, per role, to the licensed amount. To increase the number of simultaneous account sessions, please purchase additional licenses below.</p>	1	99,00 €
	<p>EVE-NG PRO Lab Editor - 1 Year License This license unlocks one additional active session for the Editor role. The Editor role is restricted to a personal folder and is authorized to create, delete, or modify additional folders, labs, and nodes within it.</p>	- 1 +	350,00 €
	<p>EVE-NG PRO Lab User - 1 Year License This license unlocks one additional active session for the User role. The User role is restricted to a personal folder and is only authorized to start, stop, and wipe nodes. An Administrator account is required to manage folders and labs within a Users folder.</p>	- 5 +	1.500,00 €

For EVE-LC role permissions, please see section **4.4**.

4.3 EVE-NG Corporate licenses

Essentially, this is EVE Learning Centre edition with Lab-Editor role-based accounts only. This is recommended for corporate use to allow full permissions for EVE labs but to restrict being able to manage other user accounts or labs. The Lab-Editor role is restricted to a shared and a personal folder and has permissions to create, delete, or modify additional folders, labs, and nodes within them.

EVE-NG Learning Centre Edition - 1 Year License

<https://www.eve-ng.net/index.php/buy-corporate/>

EVE-NG Corporate features multi user support and assigns accounts as Administrators or Lab-Editors.

The first (mandatory) Base A license allows for 2 simultaneous Admin users. It is necessary to have an Administrator account to create or manage EVE LC and other user's role-based accounts.

Example: EVE Corporate Licensing for 5 Lab-Editor users.

Licence model below includes:

- Two administrator accounts necessary for EVE Corporate labs and other user accounts management (Mandatory Base license)

- Five Lab-Editor role-based accounts. The Lab-Editor role is restricted to a shared and a personal folder and has permissions to create, delete, or modify additional folders, labs, and nodes within them.



EVE-NG Professional Base - 1 Year License

This license unlocks all Pro features and two active Administrator accounts sessions.
EVE-PRO allows up to 128 accounts to be created but restricts the number of active sessions, per role, to the licensed amount. To increase the number of simultaneous account sessions, please purchase additional licenses below.

1

99,00 €



EVE-NG PRO Lab Editor - 1 Year License

This license unlocks one additional active session for the Editor role.
The Editor role is restricted to a personal folder and is authorized to create, delete, or modify additional folders, labs, and nodes within it.

- 5 +

1.750,00 €

EVE Corporate role rights, please follow section **4.4**.

4.4 User roles comparison chart

Feature	Administrator Role	Lab-Editor/Teacher role	Lab-User/Student role
User accounts management	yes	no	no
User Accounts visibility	yes	no	no
User edit modal visibility	yes	no	no
User Folder's management	yes	no	no
Full EVE root folder tree access	yes	no	no
Licencing module access	yes	no	no
Nodes management module access	yes	yes (only own running nodes)	yes (only own running nodes)
Lab management module access	yes	yes (only own running nodes)	yes (only own running nodes)
Shared lab folder management	yes	yes	no
Shared folder access	yes	yes	yes
Shared project	yes	yes	no
Rename Folders	yes	yes	no
Create labs	yes	yes	no
Delete labs	yes	yes	no
Edit Custom topology mapping	yes	yes	no
Use only Custom topology mapping	yes	yes	yes
Lab objects management add text, drawing on labs	yes	yes	no
Export/import labs	yes	yes	no
Nodes list management	yes	yes	yes, read-only
Networks management	yes	yes	yes, read-only
Start labs	yes	yes	yes

Stop labs	yes	yes	yes
Search labs	yes	yes	yes
Wipe nodes	yes	yes	yes
Console to all nodes	yes	yes	yes
Export all configs	yes	yes	no
Edit lab	yes	yes	no
Set nodes startup-cfg to default configset	yes	yes	no
Set nodes startup-cfg to none	yes	yes	no
Topology refresh	yes	yes	yes
Topology zoom	yes	yes	yes
EVE status	yes	yes	yes
Lab details UUID	yes	yes	yes
See startup configs	yes	yes	no
Delete default startup configs	yes	yes	no
Create and manage multiconfig sets	yes	yes	no
Close labs	yes	yes	yes
Lock labs	yes	yes	no
System/Stop all nodes	yes	no	no
Information tab access	yes	yes	yes
Work with more than one lab	yes	yes	yes
Lab timer function	yes	yes	no
Lab background dark mode	yes	yes	yes
Hide node labels	yes	yes	yes
EVE Cluster administration	yes	no	no
EVE Cluster servers' assignment per user	yes	no	no

4.5 License purchasing and activation

IMPORTANT NOTE: Internet and DNS must be reachable from your Server. The EVE-NG Pro requires internet access to get updates and validate EVE-NG Pro License key. DNS must resolve names!

- ⚠ Before purchasing a license, the customer must have **EVE-NG Professional** installed and readily accessible.
- ⚠ Recommended browser for license operations is: Chrome or Mozilla Firefox
- ⚠ You must be logged in to the EVE WEB GUI as Administrator.

Step 1: Obtain your license request from the Licensing tab of the top menu of the EVE PRO WEB GUI. License requests will work only if the host machine (and hypervisor if running a VM) has **Intel VT-x/EPT** enabled!
(See section **3** for details)

Step 2: Copy the content of the license request and keep it ready for the order process at later **Step 6**. Orders without a license request cannot be processed.

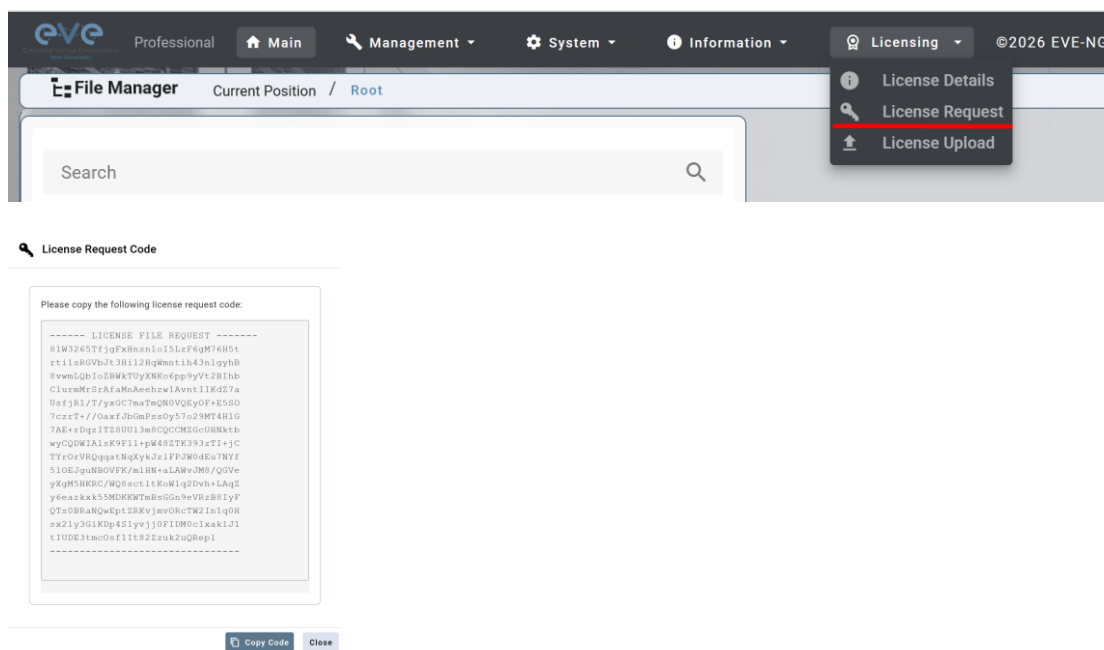

Step 3: Go to the EVE PRO or Learning Centre Purchase Portal and choose your Licenses and quantity.
Licenses that are unnecessary for your EVE Learning Centre or Corporate Edition licensing needs, can simply be deleted from your order by clicking on the cross next to them to remove them. Refer to sections: [4.2](#) and [4.3](#)

[EVE-PRO Purchase Portal](#)

[EVE-Learning Centre or Corporate Purchase Portal](#)

Step 4: Choose your preferred payment method. We currently support VISA, Mastercard, Bank/Wire transfer and PayPal.



Step 5: Complete the order form. If your license is for commercial/company use, you must select Company option.

Billing Information

Licensed to: Person Company

First name*:

Last name*:

Address*:

Step 6: At the end, please paste your **license request content (including header and footer lines)** from Step 2 and **please read** and confirm the [EULA agreement](#), which contains vital information about licenses. For companies, if necessary, in the Order Notes you can add additional information/reference, e.g. for your accounting department.

Additional Information

Order Notes

EVE-NG PRO A Base license

License Request*

Accept EULA*

Step 7: After a while (usually 10-30 mins), your license is sent to the E-Mail used in the order form.

- ⚠ **IMPORTANT:** Before loading the purchased license, make sure your EVE has Internet access. Your EVE DNS settings must be configured properly to resolve the FQDN. Internet connection is required to validate your EVE license with our EVE-NG license server.
- ⚠ **IMPORTANT:** If your EVE internet is using Proxy, make sure you have set the proxy settings described in section **3.8.3**

Step 8: Copy ALL Content of your received License. Important: License key must include header and bottom lines as well.

```
EVE-NG Professional Edition - 1 Year License
----- LICENSE FILE DATA -----
X26X8Y28Jraqm9g6gwQ7SFSBKDeyKnWX
92ep0MvFVeX8JngmD5XmEHQczkmSEmEt
SFwPzm5odick8+YOztEVE08CSUIPeY2
Z70ddXr0ADjjsSKKvdpSPvo9p9MYO7b
7E5ggXncOU9BK11SU4sX28HLKrkGz
1TOD8S+AP/AM8T4CAz2DuaEioaLkuAgS
1x/d13uaONikeALTSdniKNjs4hXIAkfcq
hG9x6lZkwOCiYbSqtqwuMJAk1IQGpD8
n6Wt84lCWPIYbSqtqwuMJAk1IQGpD8
8prutYELc8uPTV0m8QDH12GJ0IXRpo
evacuHdgIkEv89zL02Z7ywrMJOIZRnRK
1As78C6ERv8QJB5rTZ3A08FJIVvADy
aguuITgWjWm8mTas79G0TBPoXfkqJ77
EGQ+dihyveFFI3BuLqJTDXsBwX48HF1L
34nzOFDUL0PyL4uLcX8V1rYyArXUct
a+RNz8KyR42EeL0hrWfQwHIUQs0ajqs
mlnq+JMrl0e7djykhR8cnxClmKn5VX
0lCaEToaoJ3XxQAU2iQxyX7qxtdo0Jt
H00AROVV1V0nsJAclUIWmrm6I8e-----
```

Step 9: On your EVE WEB GUI, click on License Upload,

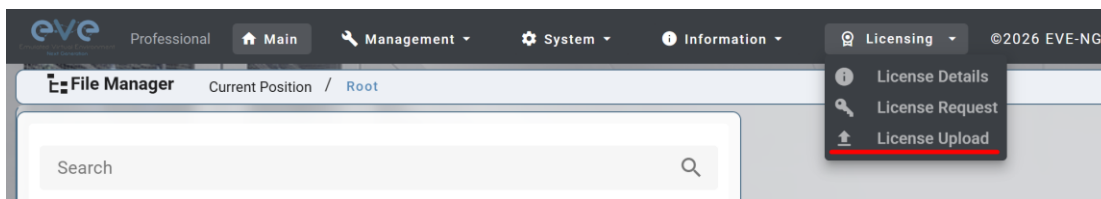

License Upload

Paste your licence and click on Upload

Please paste your license code below:

```
----- LICENSE FILE DATA -----
7Y8T100087828Qkpeo8G7pYCO1Mbh4
YpA0ad0B/zx0B0UM8JrE2j985Mw4TMMs
bVwJwXue+e0p2ToALL+LU0z90s3j2L
dXIBM0Q1R9wa96aFxm0n13eazdkKoaA
1zn9nChNpVotC0DcxN0x7revC0G8wDyk
RUSPZRiAd2BpLU7bLcSNALyc2T4p8Y12b
8bquM0XyW6L3/BgUXBU78/1Lp8WLPQ7
4f5qz890n1d3x0cnxxc0Ab/9nmx0x
1/20a0jCq0y8Vx2wa9DtrXb0azYX0Pw0
db/VV6ALFvR0vweLx00Cz6/v20vY1u
96caR0q6j7Hh0u09986up18Nov8pXK
0q1zzx0a5d680M/rqk9HupmW9a05
eSWD1Su0TFM7aLEx7b75par/bi bab in
LlFbcaK89+eA22huqUkwaLIEZ4=
-----
```

4.6 License deactivation

If you decide to deactivate EVE-PRO license on the host, please follow the steps below:

⚠ Go to EVE CLI and type:

```
cd /opt/unetlab/html/  
rm eve-ng.lic  
cp eve-ng.nolic eve-ng.lic
```

4.7 License term warning.

When your license term is close to expiration (30 days or less), you will notice yellow triangle beside Licensing. If to point the mouse on this triangle, it will show your EVE-NG valid days left till the expiration.



4.8 License Rehosting.

If you decide to re-install EVE-PRO or move it to another host, please follow the steps below:

⚠ **Pre-requisites:**

- EVE must have internet access!
- Only ONE EVE host must be turned ON and connected to the internet, do NOT have more than one EVE with the same license turned on at the same time!

Step 1. Make sure that you have only ONE EVE-PRO instance with this license running.

Step 2. Make sure you have unrestricted Internet access with a properly configured DNS server from your EVE server.

Step 3. Load your purchased license onto EVE server you want to rehost to.

Step 4. Reboot your new EVE

Step 5. Wait approximately one hour for the licence validation process to finish on the host.

⚠ **NOTE:** The re-hosted EVE server must have internet access to periodically validate the license. EVE receives a token with a licence validity time of 24 hours. During those 24 hours, the re-hosted EVE can be used offline. After 24 hours the token time expires and you have to get EVE online again (for approximately 30 minutes) to receive a new token.

5 EVE-NG Professional Update & Upgrade

⚠️ **Prerequisites:** Internet access and working DNS on your EVE-NG is required.

Verify your internet reachability with named ping. Example: ping www.google.com

```
ping www.google.com
```

```
root@eve-ng:~# ping www.google.com
PING www.google.com (216.58.207.228) 56(84) bytes of data:
64 bytes from arn09s19-in-f4.1e100.net (216.58.207.228): icmp_seq=1 ttl=58 time=9.11 ms
64 bytes from arn09s19-in-f4.1e100.net (216.58.207.228): icmp_seq=2 ttl=58 time=19.5 ms
64 bytes from arn09s19-in-f4.1e100.net (216.58.207.228): icmp_seq=3 ttl=58 time=9.50 ms
64 bytes from arn09s19-in-f4.1e100.net (216.58.207.228): icmp_seq=4 ttl=58 time=9.56 ms
64 bytes from arn09s19-in-f4.1e100.net (216.58.207.228): icmp_seq=5 ttl=58 time=9.56 ms
```

If your ping is success, follow next step for update. If named ping has no success, please verify your DNS IP assigned for EVE or firewall. Some cases ping can be blocked by FW, but Internet and DNS are capable to make update/upgrade.

5.1 EVE-NG Professional Update

It is strongly recommended to keep your EVE-NG up to date. To update and upgrade, SSH to your EVE CLI.

To verify your current EVE-NG version, please follow “CLI diagnostic information display commands” in section **16.1.1**. You can verify your current EVE version from the System/System Status tab on the top menu of the WEB GUI as well.

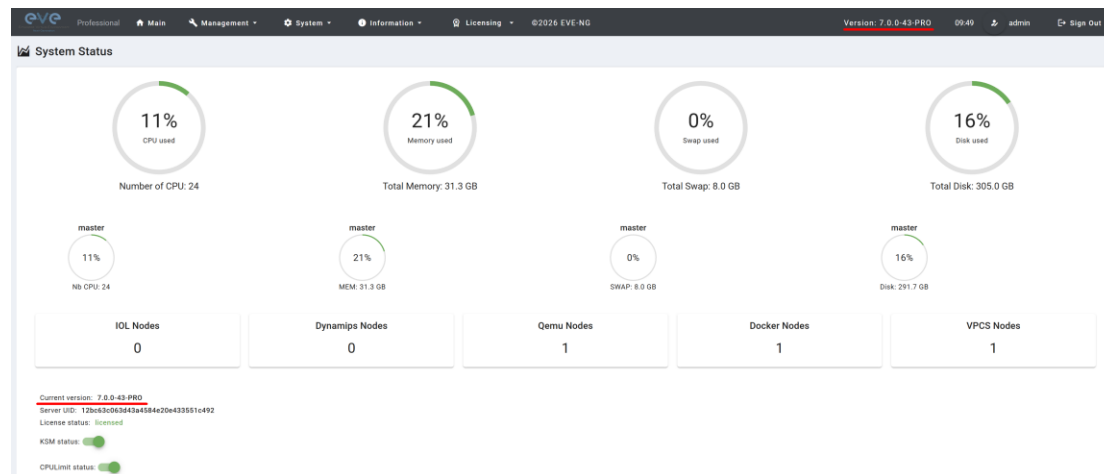

The newest version of EVE-NG can be verified by checking the official website: <https://www.eve-ng.net>. For update to the newest EVE-NG Professional version please follow the steps <https://www.eve-ng.net/index.php/1845-2/>

Type the below commands followed by Enter

```
apt update
```

In case the prompt asks to confirm with Y/N, answer Yes.

5.2 EVE-NG Professional Upgrade

⚠ **IMPORTANT NOTE:** Make sure you have stopped all your running labs. All nodes in the EVE must be stopped before upgrade!

For upgrade to the newest EVE-NG Professional version please follow the steps <https://www.eve-ng.net/index.php/1845-2/>

Type commands followed by Enter

```
apt upgrade
```

In case the prompt asks to confirm with Y/N, answer Yes.

⚠ **IMPORTANT NOTE:** If you are upgrading EVE PRO from older version, the installation may ask you to confirm additional! Information:

```
Configuration file '/etc/issue'
==> Modified (by you or by a script) since installation.
==> Package distributor has shipped an updated version.
What would you like to do about it? Your options are:
  Y or I : install the package maintainer's version
  N or O : keep your currently-installed version
  D      : show the differences between the versions
  Z      : start a shell to examine the situation
The default action is to keep your current version.
*** issue (Y/I/N/O/D/Z) [default=N] ? _
Progress: [ 0%] [.....]
```

Answer for prompt above is “N”

```
Configuring grub-pc
A new version (/tmp/grub.tj7zRCnt3z) of configuration file /etc/default/grub is available,
but the version installed currently has been locally modified.

What do you want to do about modified configuration file grub?

  install the package maintainer's version
  keep the local version currently installed
  show the differences between the versions
  show a side-by-side difference between the versions
  show a 3-way difference between available versions
  do a 3-way merge between available versions (experimental)
  start a new shell to examine the situation

  <Ok>
```

Answer for grub-pc version is: “**Keep the local version currently installed**”

After the completion of the update and upgrade, reboot your EVE Server. Type the following command and hit enter.

```
reboot
```

⚠ **IMPORTANT NOTE:** Do NOT make EVE updates or upgrades from within the HTML5 Desktop console!

6 Types of EVE management consoles

⚠ IMPORTANT NOTE: EVE Console TCP ports. EVE Pro uses a dynamic port range between 1-65000. Dynamic means that every time you start a node on the lab, EVE assigns any free port from this range for Telnet, VNC or RDP access. Static TCP port assignment for Telnet sessions is not available in EVE PRO.

EVE Pro supports three different console types.

6.1 Native console

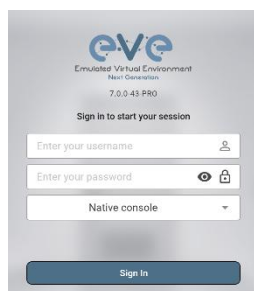

EVE Native console option requires locally installed software to access your lab nodes. To use the Native console option, you must have Administrator rights on your PC and ensure the TCP port range 1-65000 is not blocked by a firewall or antivirus software.

6.1.1 Native Console: telnet

Windows OS: You can use your preferred telnet program like Putty, SecureCRT or others. Example: Putty as native telnet client on Windows. To setup Windows native telnet client please follow section [3.9.1](#)

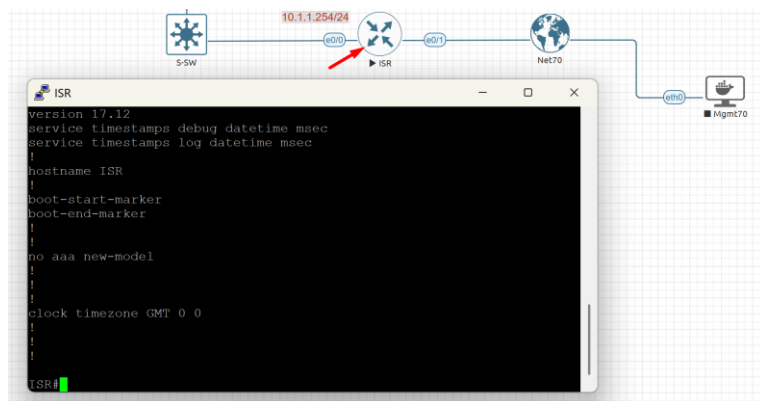

Linux OS: You can use your preferred telnet program like the Native Terminal, SecureCRT, or others. Example: Telnet client from the native terminal on Linux Mint. To setup Linux

native telnet client please follow section 3.9.2

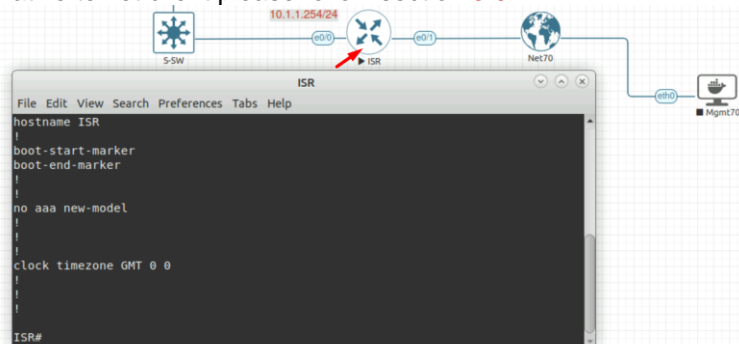

MAC OSX: You can use your preferred telnet program like the native Terminal, SecureCRT, or others.

Example: Telnet client from the native terminal on MAC OSX. To setup MAC OSX native telnet client please follow section 3.9.3

6.1.2 Native Console: Wireshark

EVE Professional V7 is using locally installed Wireshark application for Native Console. This allows live captures with Wireshark installed on the client machine.

Right click on the node you wish to capture, choose capture and the interface. Capture Session will open in a Wireshark application window.

EVE-PRO with Local Wireshark supports packet captures on ethernet interfaces. Select the interface frame type which will be captured:

- Ethernet for Ethernet, Fast Ethernet, Gigabit Ethernet.

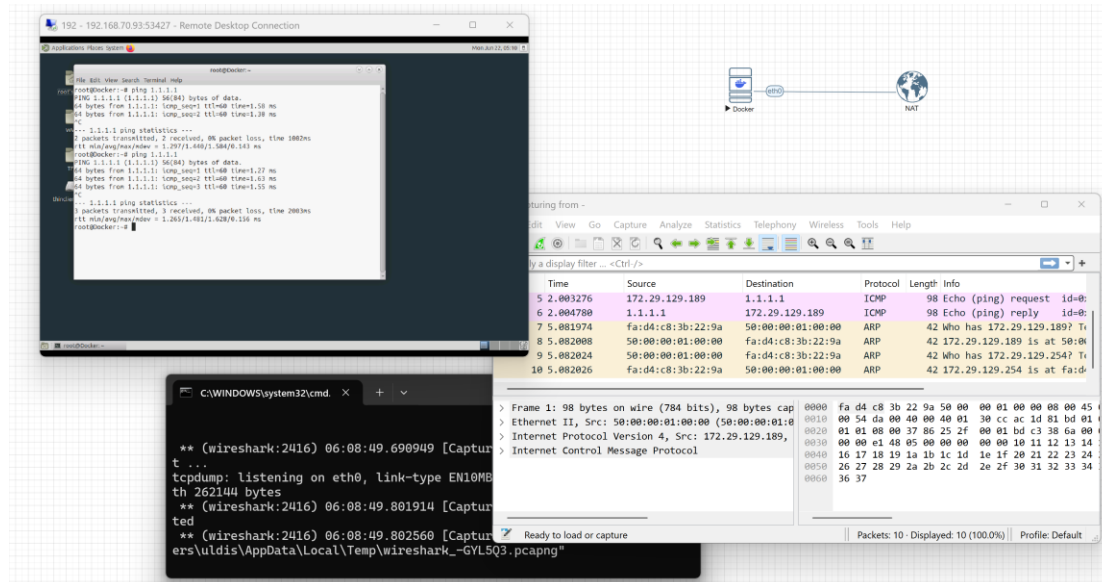

Example: Docker live interface eth0 capture.

To save the captured file on your local PC, please refer to section 12.1

Native Console: VNC

Windows OS: Recommended and tested is UltraVNC but any other compatible one can be used.

Example: UltraVNC as Native VNC client on Windows. To setup Windows native VNC client please follow section [3.9.1](#)

Linux OS: Remote Desktop Viewer for VNC Sessions.

Example: Remote Desktop Viewer for VNC sessions on Linux Mint. To setup Linux native Remote Desktop Viewer please follow section [3.9.2](#)

MAC OSX: Preferred VNC program: Chicken VNC

Example: Chicken VNC as Native VNC client on MAC OSX. To setup MAC OSX native RDP Viewer client please follow section [3.9.3](#)

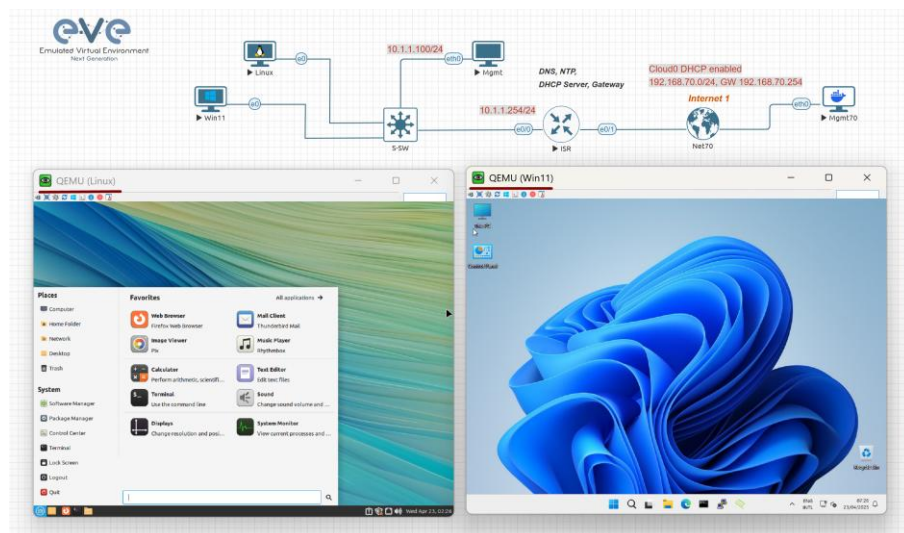

Example: Windows Ultra VNC consoles, Linux and Windows

6.1.3 Native Console: RDP

Windows OS: Windows Native RDP.

Example: Windows RDP session to Win11 host in the lab.

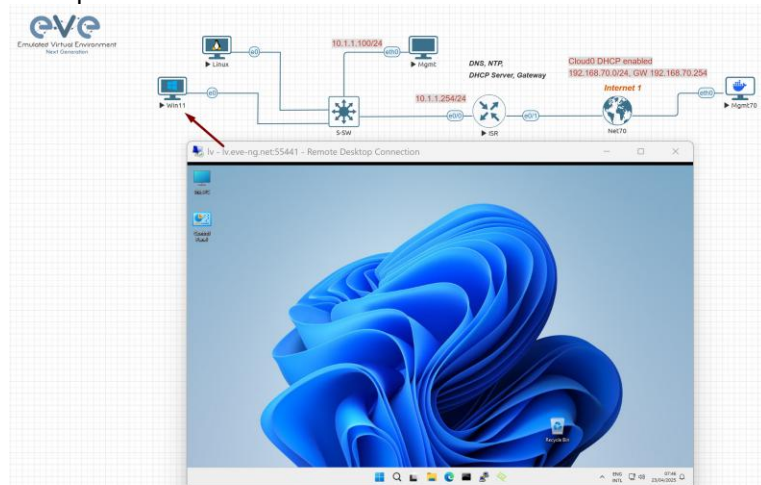

Linux OS: Remote Desktop Viewer as RDP session to lab Win11 host.

Example: RDP session to Win11 host in the lab. To setup Linux native Remote Desktop Viewer please follow section [3.9.2](#)



MAC OSX: Remote Desktop Viewer as RDP session to lab Win10 host.
Example: RDP session to Win10 host in the lab.
To setup MAC OSX native RDP Viewer client please follow section [3.9.3](#)

6.2 HTML5 console

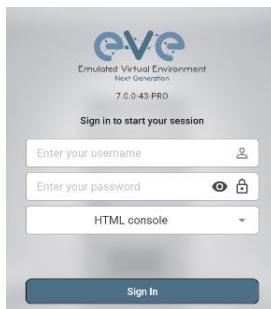

The EVE PRO HTML5 console provides a clientless solution for managing labs and node sessions. Management is achieved directly through the browser by using the Apache Guacamole HTML5 Engine. It is very convenient for corporate users with restricted Workstation permissions (Locked Telnet, vnc, rdp).

EVE-PRO with integrated Docker Wireshark supports packet captures on.

Select the interface frame type which will be captured:
Ethernet for Ethernet, Fast Ethernet, Gigabit Ethernet.

6.2.1 HTML5 Console window functions

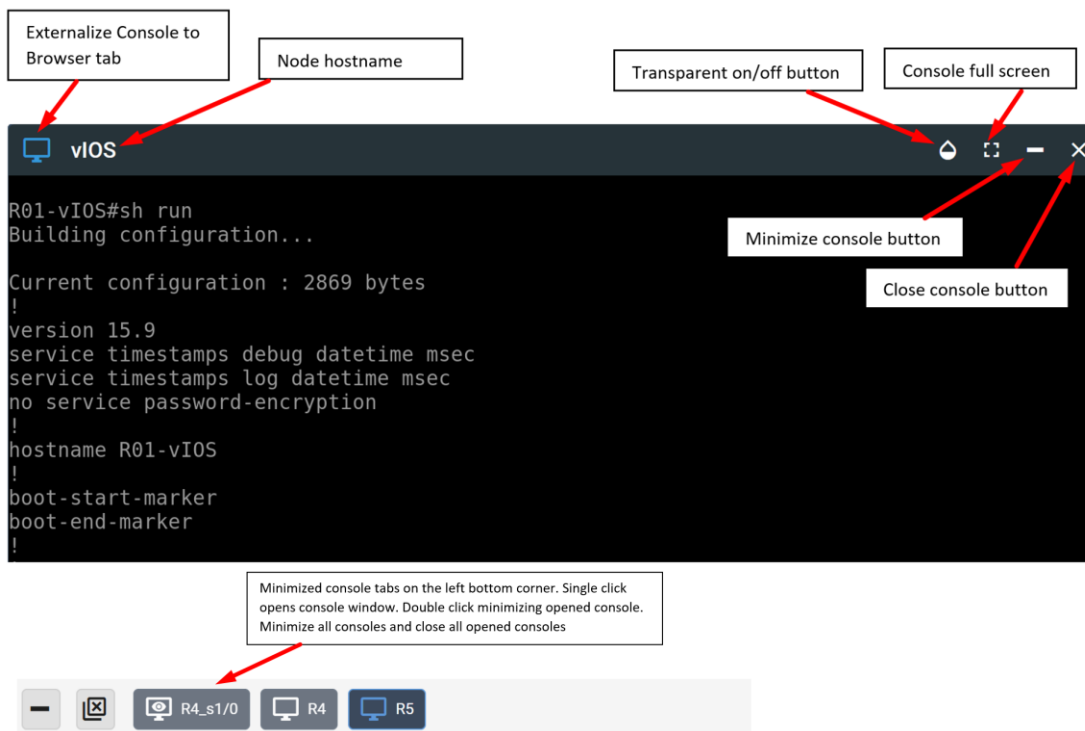

6.2.2 HTML5 Console: Telnet

HTML5 Telnet console is integrated and opens telnet sessions in the browser.

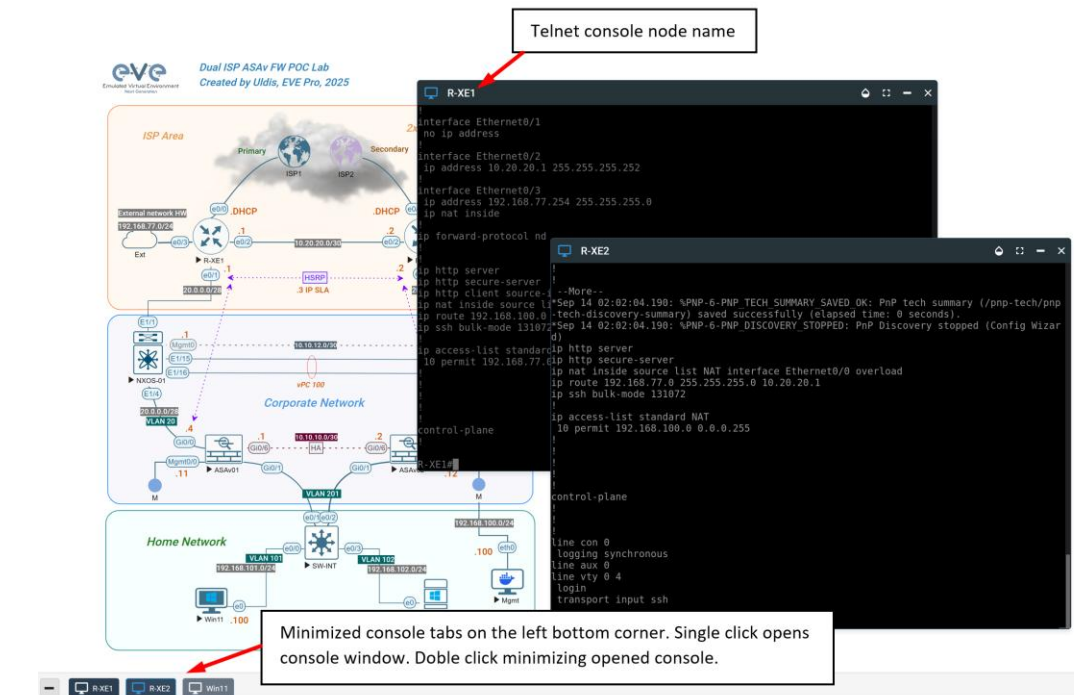

Option: The new Chrome v70.0.3538.110 and higher allows the use of the copy/paste function inside the HTML session. Type in your Chrome browser

“**chrome://settings/content/clipboard**” and press **Add** to allow the use of the clipboard extension for your EVE Server: **https://your_ip:443**

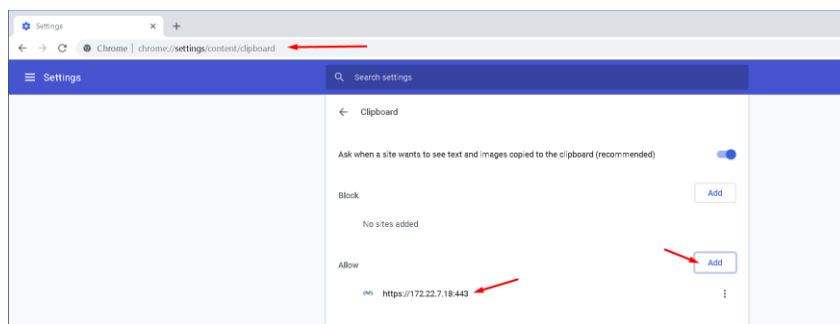

Option: The new Firefox v 63.0.3 and higher allows the use of the copy/paste function inside the HTML session. Type in your Firefox browser “**about:config**” and enable clipboard values below:

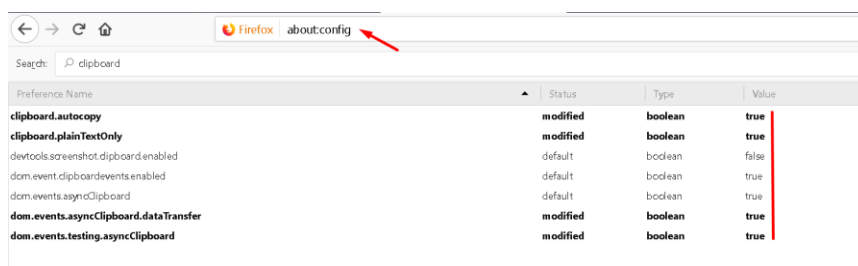

6.2.3 HTML5 Console: Wireshark

EVE Professional V7 has an integrated Wireshark Docker station for HTML Console. The EVE Capture console uses an integrated HTML session. Right click on the node you wish to capture, choose capture and the interface. Capture Session will open in a new browser window.

EVE-PRO Integrated docker Wireshark supports packet captures on ethernet and serial interfaces.

Select the interface frame type which will be captured:

- Ethernet for Ethernet, Fast Ethernet, Gigabit Ethernet.
- Serial interface frames (IOL Only): HDLC, PPP or Frame Relay.

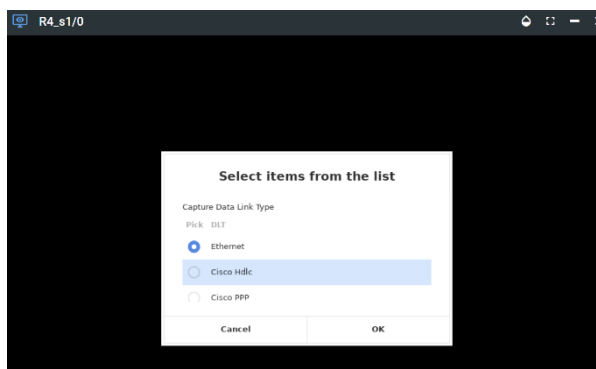

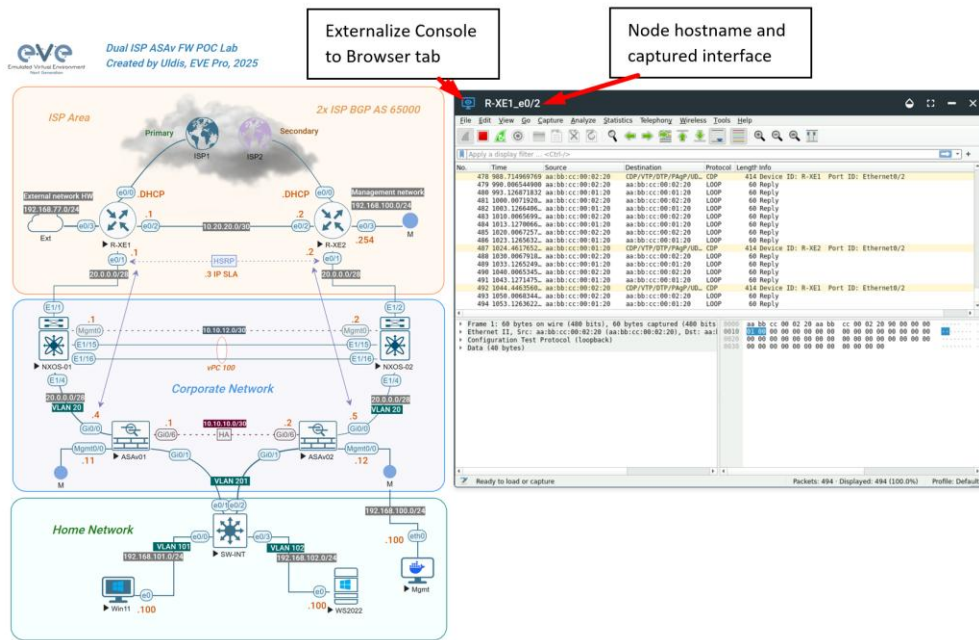

To save captured file to your local PC, please refer section 12.2

6.2.4 HTML5 Console: VNC

HTML5 VNC console is integrated and opens VNC sessions in the browser.

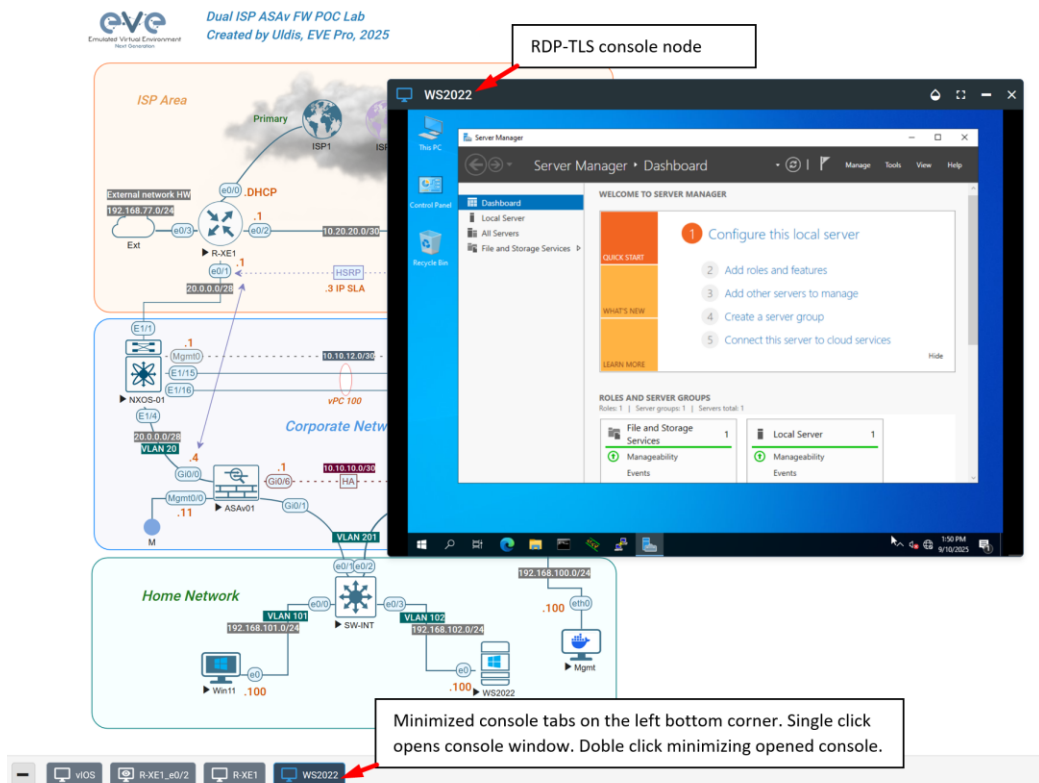

6.2.5 HTML5 Console: RDP

HTML5 RDP console is integrated and opens RDP sessions in the browser. For Windows 7, 8, 10, 11, Windows Server 2016, 2019, 2022, 2025 please mind the note below.

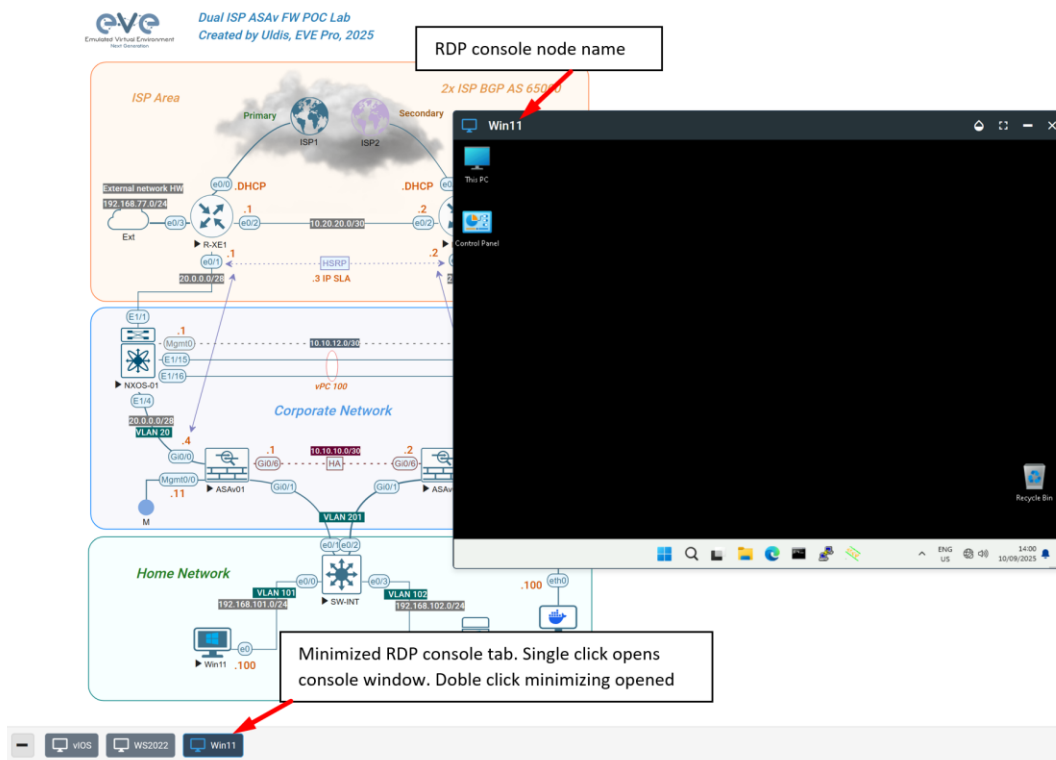

⚠ IMPORTANT NOTE: For all Windows nodes, the console type must be set to **RDP-TLS** in the node template. RDP-TLS node console option is actually only used with HTML5 RDP sessions.

The username and the password can be configured in the node edit settings. This will allow you to resize HTML RDP console without re-login in the windows host.

Example below, Edit node, Win11, Console type rdp-tls, username: user and password: Test123

Add Node

Template

Main Settings

Image

Icon

Name/prefix

Number of Nodes

Satellite

Delay (s)

Startup configuration

X Position

Y Position

Additional Settings

QEMU Settings

QEMU Version

QEMU Arch

QEMU Nic

QEMU custom options

CPU

RAM

CPU Limit

Ethernets

Console

RDP Username

RDP Password

Additional Options

UUID

First Eth MAC Address

6.3 HTML5 Desktop console

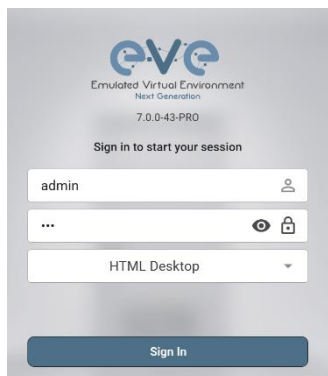

EVE PRO HTML5 Desktop provides a full-featured clientless solution for managing labs and node sessions. Management is achieved directly through the browser by using an integrated docker desktop that is accessed through the Apache Guacamole HTML5 Engine. The docker contains a full featured Linux desktop and is very convenient for corporate users with restricted workstation rights (locked telnet, vnc, rdp).

6.3.1 Login to HTML5 Desktop console

Step 1: On your first login to the EVE HTML5-Desktop console, EVE will open a new HTML window session to an integrated Docker management station. On the Desktop you will see another EVE login icon.

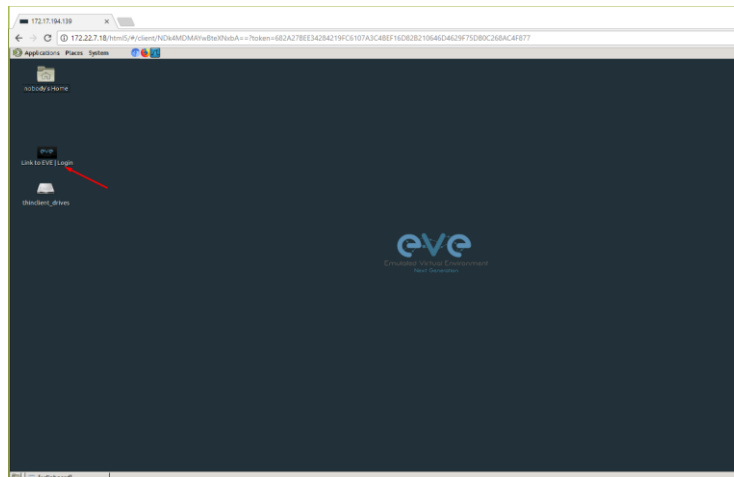

Step 2: Double-click the “Link to EVE | Login” icon and log into EVE using **NATIVE** console.

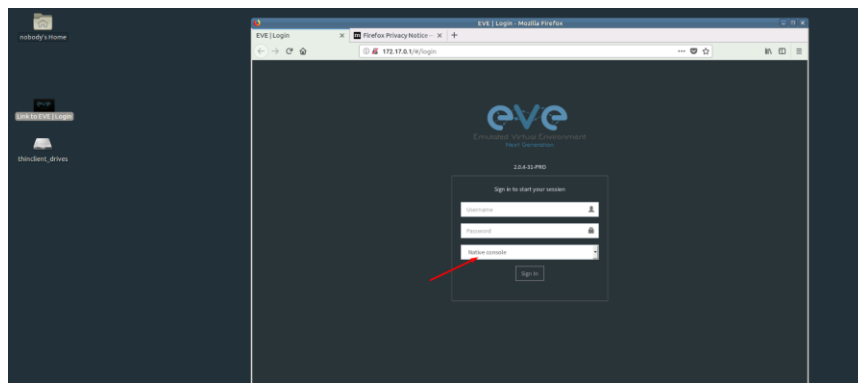

Inside of the integrated docker station, it will open another session to EVE. All features inside of the Docker Desktop will work as you are used to with the Native console.

6.3.2 HTML5 Desktop Console: telnet

The integrated management docker station telnet client allows you to telnet to nodes. Telnet sessions are in a tabbed style as shown below.

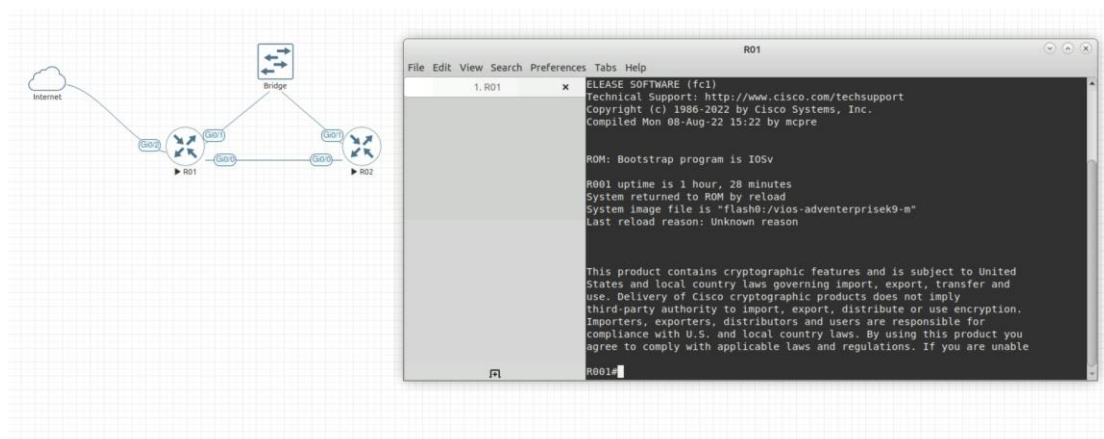

6.3.3 HTML5 Desktop Console: Wireshark

Right click on the node you wish to capture, choose capture and select the relevant interface. The capture will open in an RDP session window.

EVE-PRO supports packet captures on ethernet and serial interfaces.

Select the interface frame type which will be captured:

- Ethernet for Ethernet, Fast Ethernet, Gigabit Ethernet.
- Serial interface frames: HDLC, PPP or Frame Relay.

The integrated management docker station Wireshark client allows you to capture and save captured files onto the docker station. For instructions on how to save files to your local PC, please refer to section 12.3

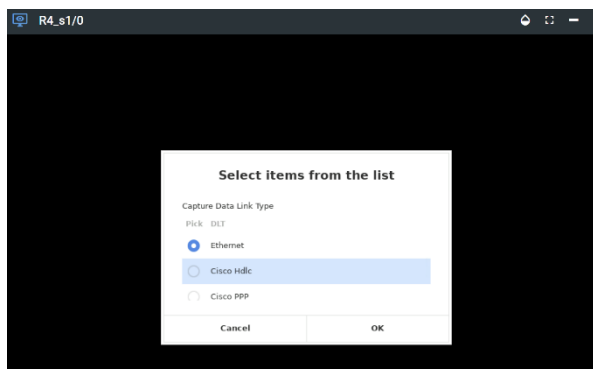

6.3.4 HTML5 Desktop Console: RDP

The integrated management docker station RDP client allows you to open Remote Desktop sessions to Windows nodes. For directions on how to transfer files to the local PC, please refer to section 13



6.3.5 HTML5 Desktop Console: ThinClient Files exchange

The HTML5-Desktop console offers an amazing feature that allows you to exchange files between your host PC and the EVE management Linux host. Please refer to section [13](#) for detailed instructions.

7 EVE WEB GUI Management

7.1 EVE Management Page



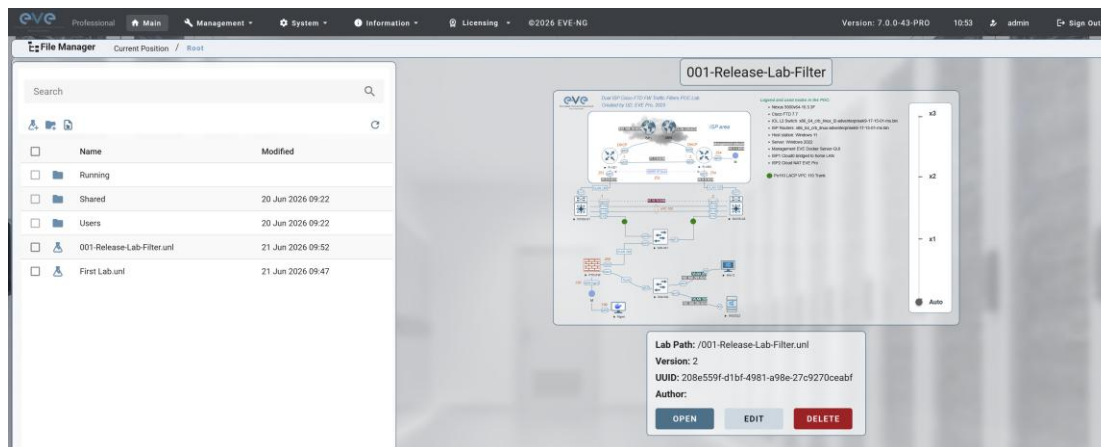



The Main EVE management window





The lab preview actual picture appears after 3-5 seconds.

7.1.1 Management buttons







Button	Description
	Select All or Deselect All folders or labs in the EVE tree
	Create/Add new Lab
	Create new folder
	Import an EVE lab or lab folder from a previous export. Import file must be in .zip format
	Export EVE lab or folder. Select folder(s) and/or labs you wish to export and select this option. The export is saved to your local PC in .zip format and is ready to import to another EVE.
	Move EVE lab or folder to other location. Select folder(s) and/or labs you wish to move.

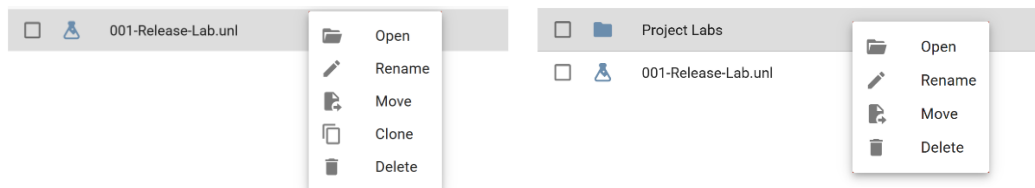

	<p>Delete selected folders or labs. You cannot delete the Shared, Users or Running folder.</p>												
	<p>Lab Search function, case insensitive and match directory as well</p> <div data-bbox="411 450 906 651"> <p>001-Rel <input type="text" value="001-Rel"/> <input type="button" value="Search"/></p> <p><input type="button" value="Refresh"/></p> <table border="1"> <thead> <tr> <th><input type="checkbox"/></th> <th>Name</th> <th>Modified</th> </tr> </thead> <tbody> <tr> <td><input type="checkbox"/></td> <td>..</td> <td></td> </tr> <tr> <td><input type="checkbox"/></td> <td> 001-Release-Lab-For-Share.unl</td> <td>26 Jan 2025 22:53</td> </tr> <tr> <td><input type="checkbox"/></td> <td> 001-Release-Lab-For-Share_Team.unl</td> <td>11 Mar 2025 11:31</td> </tr> </tbody> </table> </div>	<input type="checkbox"/>	Name	Modified	<input type="checkbox"/>	..		<input type="checkbox"/>	001-Release-Lab-For-Share.unl	26 Jan 2025 22:53	<input type="checkbox"/>	001-Release-Lab-For-Share_Team.unl	11 Mar 2025 11:31
<input type="checkbox"/>	Name	Modified											
<input type="checkbox"/>	..												
<input type="checkbox"/>	001-Release-Lab-For-Share.unl	26 Jan 2025 22:53											
<input type="checkbox"/>	001-Release-Lab-For-Share_Team.unl	11 Mar 2025 11:31											
	<p>Refresh current folder content</p>												
<p>Name ↓</p> <p>Modified ↓</p>	<p>Toggle the sorting folders and labs between alphabetical and last edit date.</p>												

7.1.2 Right click dropdown menu



Function	Description
	<p>Opens Folder or Lab.</p>
	<p>Rename Folder or Lab.</p>
	<p>Move selected item(s) to a different location. To use this option, please select the folder(s) or lab(s) that you want to move.</p>
	<p>Clone Lab. Clone function creates a copy of lab topology and exported configurations.</p>
	<p>Delete selected folders or labs. You cannot delete the Shared, Users or Running folder.</p>

7.1.3 Management tabs

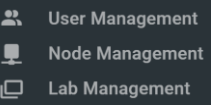
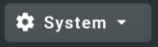
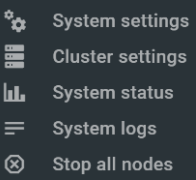
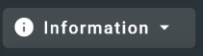
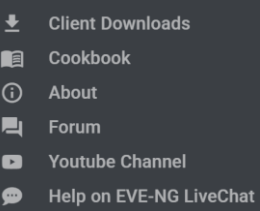
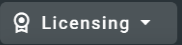
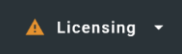
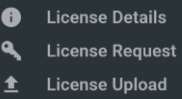
Tab	Description
 Main	Returns back to the EVE Home Management screen.
 Management ▾ 	<p>Management dropdown, opening the management submenu.</p> <p>Management submenu, refer to sections: 7.3, 7.3.2, 7.3.3</p>
 System ▾ 	<p>System dropdown.</p> <p>System submenu, refer to section 7.4</p>
 Information ▾ 	<p>Information dropdown</p> <p>Information submenu, for details see section 7.5</p>
 Licensing ▾  Licensing ▾ 	<p>Licensing dropdown</p> <p>Yellow triangle appearance means, that your EVE server is validating a license. If your EVE server is offline this Triangle sign can be show permanently</p> <p>Licensing management, please see section 4</p>

7.2 Folders and Lab files management

This section will explain how to manage folders and labs on the EVE management page.

7.2.1 Folders Management

EVE Professional has three default folders used for various operations. These cannot be deleted or renamed (see below).

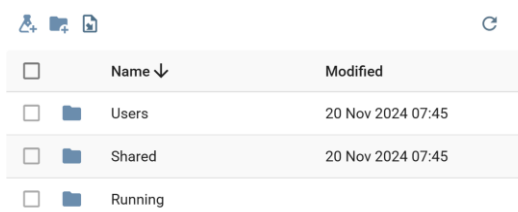

<input type="checkbox"/>	Name ↓	Modified
<input type="checkbox"/>	Users	20 Nov 2024 07:45
<input type="checkbox"/>	Shared	20 Nov 2024 07:45
<input type="checkbox"/>	Running	

- Admins can create additional folders for any user.
- Editors can create or manage folders in their own profile/folder or within the Shared folder

7.2.1.1 Default folder Running

EVE professional allows a single user to run multiple labs and switch between them with the Running folder.



<input checked="" type="checkbox"/>	Running	
<input type="checkbox"/>	Project Labs	21 Apr 2025 19:38

Example:

- Start a lab and close it
- Open and start another lab and close it

When you open your Running folder, you will see both running labs in it. It is easy to switch between labs.

The example below is showing two running labs in the Running folder.

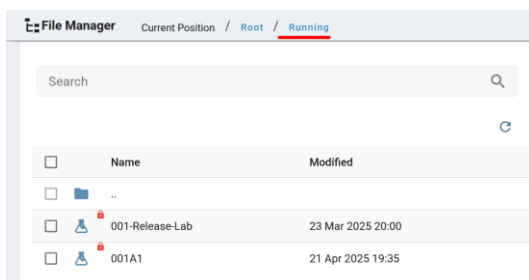

<input type="checkbox"/>	Name	Modified
<input type="checkbox"/>	..	
<input type="checkbox"/>	001-Release-Lab	23 Mar 2025 20:00
<input type="checkbox"/>	001A1	21 Apr 2025 19:35

7.2.1.2 Default folder Shared

To manage the Shared folder an **Admin or Editor** user account is required.

The EVE Professional Shared folder is visible to all EVE users. Admin and Editor Accounts can create folders or labs and place them into the Shared folder.

<input type="checkbox"/>	Shared	20 Nov 2024 07:45
<input type="checkbox"/>	Users	20 Nov 2024 07:45

Example: An Admin creates a lab and places it into the Shared folder.

The Shared Lab is recommended to set “any” Cluster Satellite

Step 1: Create a lab, refer to section 8.1

Step 2: Select the lab or folder you wish to move to the Shared folder and press **Move** (or create it in the Shared folder from the start).

The screenshot shows the File Manager interface with the 'Root' directory selected. A list of folders and files is displayed, including 'Running', 'Shared', 'Users', 'Project Labs', and two '001-Release-Lab-B.unl' files. The '001-Release-Lab-B.unl' file is selected. To the right, the 'Move to Folder' dialog is open, showing a 'Target Path' dropdown set to '/' and a list of folders: 'Shared', 'Users', and 'Project Labs'. The 'Shared' folder is highlighted, and a red arrow points to it. 'MOVE' and 'CANCEL' buttons are at the bottom right of the dialog.

Step 3: Another user account can use the lab placed by the Admin in the Shared folder

The screenshot shows the File Manager interface with the 'Shared' directory selected. The list of files and folders shows a single file: '001-Release-Lab-B.unl' with a modification date of '21 Apr 2025 20:44'.

- ⚠ NOTE: Every user has its own profile; this means that every user has an independent Running folder where this lab runs independently from other users.
- ⚠ NOTE: Labs can be created and modified (e.g. settings and preconfigs) by an Admin or an Editor user. The User role can use the lab only exactly the way it was configured by an Admin or Editor and is unable to change any settings.
- ⚠ NOTE: Admins and Editors can create folders and labs inside the Shared directory

7.2.1.3 Default folder Users

To manage the Users folder, an **Admin** user account is required.

The Users directory is a default EVE folder where Editors and Users have their personal folders stored.

<input type="checkbox"/>	Shared	21 Apr 2025 20:48
<input type="checkbox"/>	Users	20 Nov 2024 07:45

Once an Admin has created a new Editor or User account, EVE will automatically create a folder with the user login name under the default directory Users.

Example: Below you can see the folders for the users with the following login names: **test2**, **test3** and **test4**

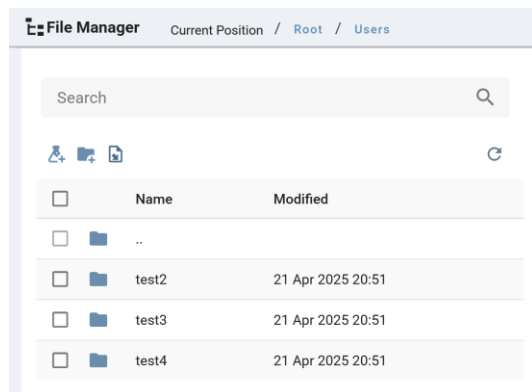

⚠ NOTE: An Admin can manage any user's folder or place labs in it.

7.2.1.4 Create folder

An **Admin** or **Editor** user account is required.

Click to add new Folder, Type the new folder name and click "Create"

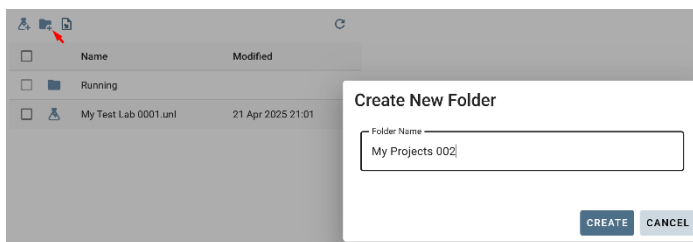

⚠ NOTE: Editors can only create folders within their own profile folder or in the Shared folder

7.2.1.5 Delete folder

An **Admin** or **Editor** user account is required.

Select or right click to the folder you wish to delete and press Delete.

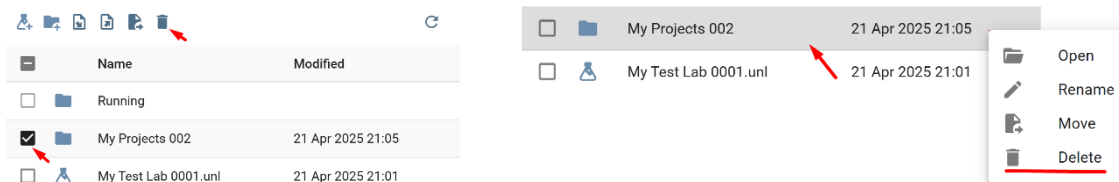

⚠ NOTE: All folder content will be deleted as well.

⚠ NOTE: Editors can only manage their own or the Shared folder

7.2.1.6 Move Folder

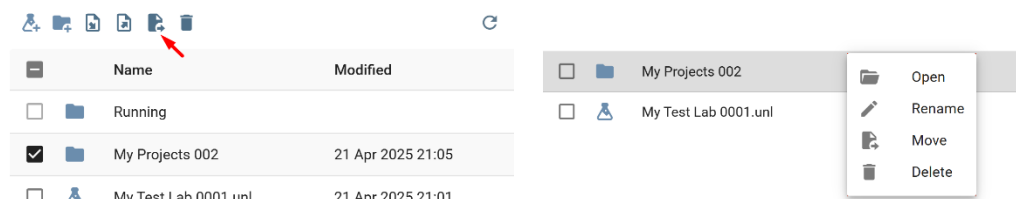

An **Admin** or **Editor** user account is required.

Select or right click the folder you wish to move and press the Move.

⚠ NOTE: Editors can only manage their own or the Shared folder

Select the target destination for your folder and confirm by clicking on Move.

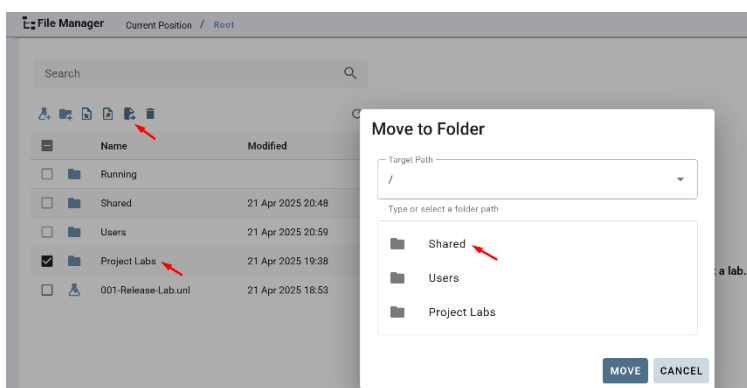

7.2.1.7 Export Folder

Select the folder(s) you wish to export from your EVE and press Export.

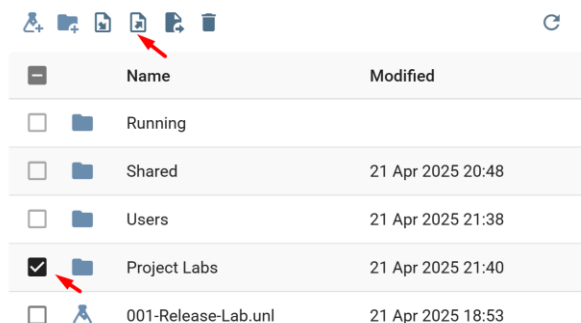

Save the exported file as .zip to your local PC. The exported zip file is ready to import to another EVE instance.

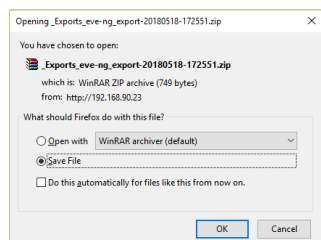

If your browser is set to save downloaded files to a default directory, your exported file will be saved in the browsers default downloads directory.

7.2.1.8 Import Folder

⚠ **IMPORTANT:** Importable file **MUST** be in .zip format, do **NOT** unzip the file.

Step 1: Press the Import button.

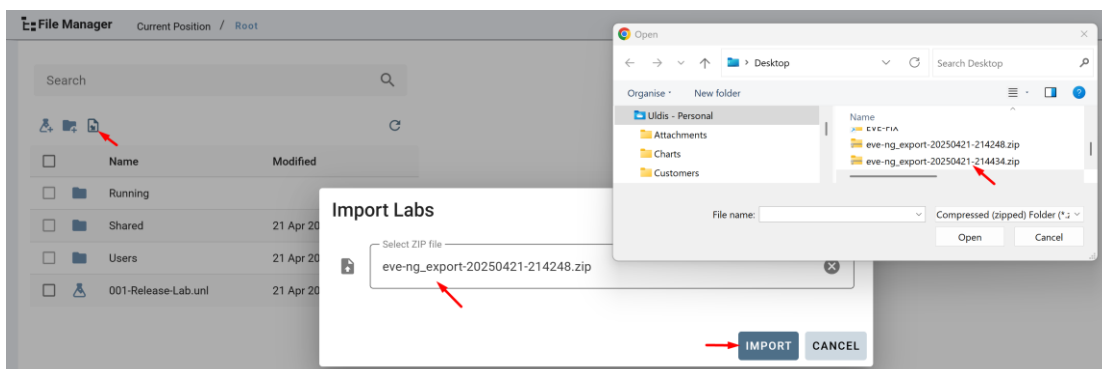

Step 2: Click Select ZIP File, find the zipped file that contains EVE folder with labs.

Step 3: Press the Import Button

7.2.2 Lab files Management

You can manage created labs from the main EVE file manager window

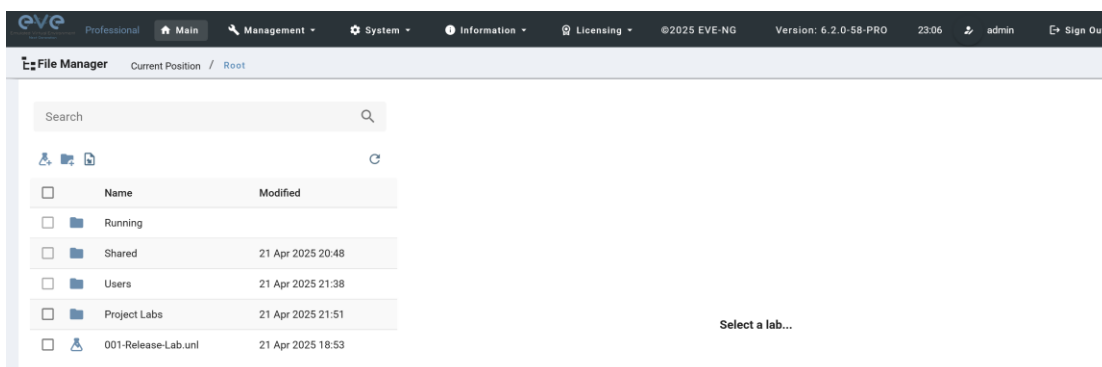

7.2.2.1 Create Lab

The **Admin** or **Editor** user account is required.

⚠ **NOTE:** An Editor can create labs only within his personal folder or in the Shared folder

Click on the New Lab button and refer to section [8.1](#)

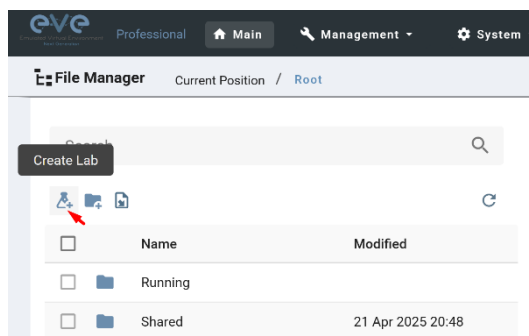

7.2.2.2 Delete Lab

The **Admin or Editor** user account is required to delete labs.

⚠ NOTE: An Editor can delete labs only within his personal folder or in the Shared folder

Step 1: Select the lab or labs you wish to delete and then press the Delete button

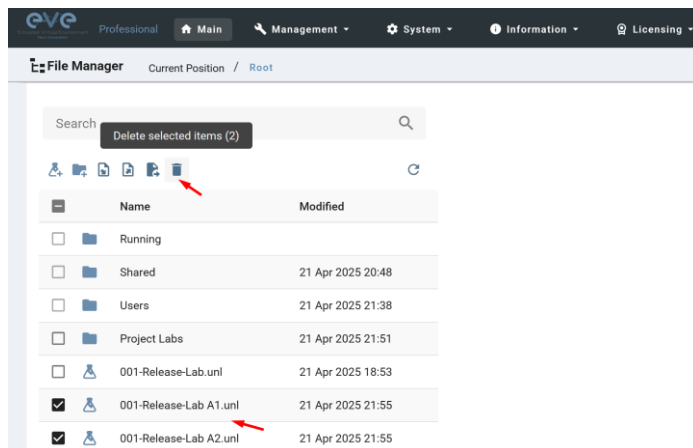

7.2.2.3 Clone Lab

The **Admin or Editor** user account is required to clone labs.

⚠ NOTE: An Editor can create labs only within his personal folder or in the Shared folder

The cloning feature provides a very convenient way to duplicate original labs to share with others or base another lab on it.

Cloned labs will copy exported configs (on supported nodes) but will not copy saved states/configurations in Qemu nodes like Windows hosts, Cisco ISE, or other Qemu nodes. Please refer to section **10.3** for more information on configuration export for labs.

Step 1: Right click on the lab you wish to clone. Click on Clone.

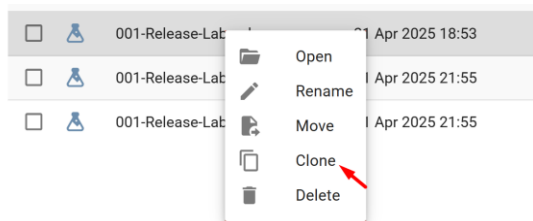

Step 2: Your lab will be cloned with all your exported configurations or configuration sets with a new name.



Step 3: The lab has been cloned lab and can be renamed to your liking. Right click to the cloned lab and choose Rename.

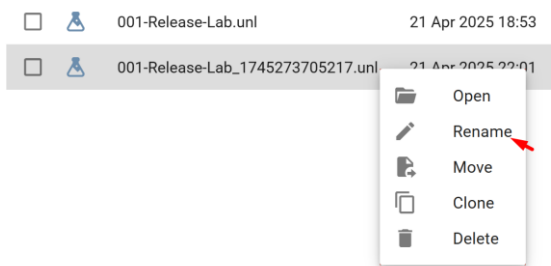

Step 4: Rename it, and click Rename to confirm

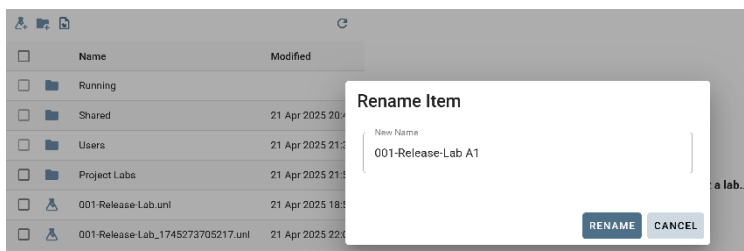

7.2.2.4 Move Lab

The **Admin** or **Editor** user account is required to move labs.

⚠ NOTE: An Editor can create labs only within his personal folder or in the Shared folder

Step 1: Select the lab you wish to Move and click move.

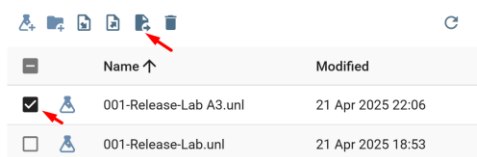

Step 2: Choose the path to the new destination and confirm by clicking Move

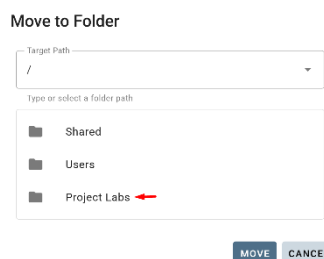

7.2.2.5 Export Lab

Select the Lab(s) you wish to export from your EVE Server and press Export.

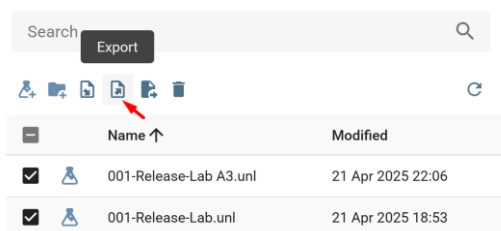

Save exported file as .zip to your local PC. The exported zip file is ready to import into another EVE.

If your browser is set to save downloaded files to default directory, your exported file will be saved in the browsers default downloads directory.

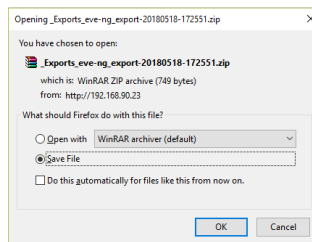

7.2.2.6 Import Labs

⚠ IMPORTANT: Importable file **MUST** be in .zip format, do **NOT** unzip the file.

Step 1: Press the Import button.

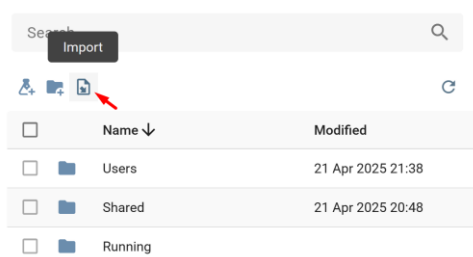

Step 2: Select the zipped file which contains the EVE labs.

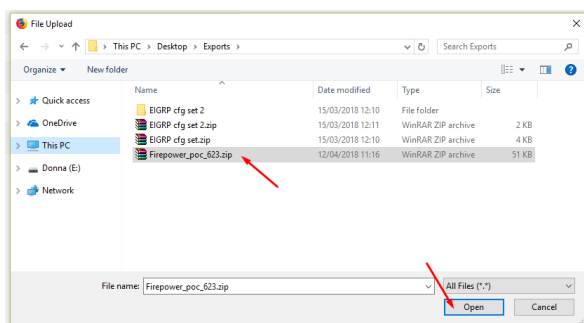

Step 3: Press the Import Button

7.3 EVE Management Dropdown Menu

7.3.1 EVE User management

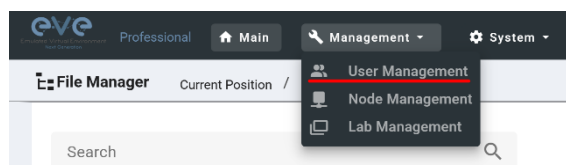

The User Management page, under the Management dropdown, will allow Admin accounts to manage other user accounts.

⚠ Only the **Admin** role is allowed to create or edit user accounts.

7.3.1.1 Creating a new EVE User

Step 1: Open the User management submenu. Management>User management and click Add user

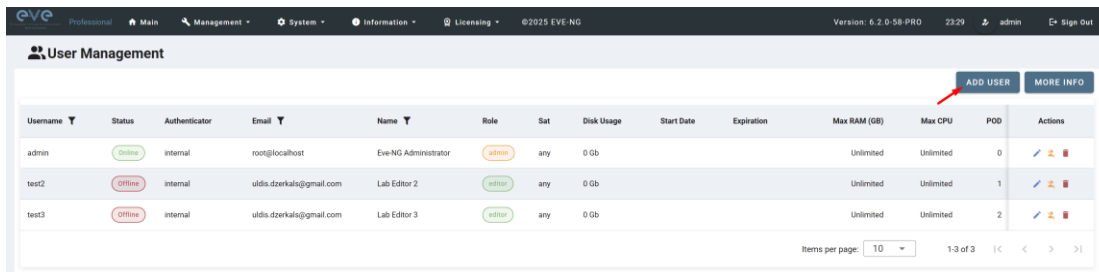

Step 2: The Add New User management window will pop up. Fill in the main information about your EVE user

Add User

User Name*

Password

Confirm Password

Authentication

internal

Name*

Use only [A-Za-z0-9_].chars

Email*

Role*

Administrator

Console

any

Satellites

any

Account Validity

From: DD/MM/YYYY To: DD/MM/YYYY

Quotas

CPU: -1 RAM (GB): -1

SAVE CANCEL

Step 3: If your user will be Radius authenticated, please Select Radius from Authentication menu. Passwords will be stripped off, because authenticator will look Radius server for user password. How to setup radius server IP and Shared secret please follow Section: [17.1](#)

User Name*

Password

Confirm Password

Authentication

radius

Step 4: If your user will be Active Directory (LDAP) authenticated, please enable Active Directory from Authentication Menu. Passwords will be stripped off, because authenticator will look Active Directory server for user password. How to Active Directory server IP please follow

NOTE: Username for Active Director must contain domain at the end of username. Example: **test4@eve-ng.net**

User Name*

Password

Confirm Password

Authentication

Step 5: If you have bought other EVE licenses, you can choose the preferred user role. For licensing and user roles please refer to section **4**

Role*

- Administrator
- Lab Editor
- Lab User

Step 6: Set the Console type for the user. If Console type is set exact: Native, HTML or HTML5 Desktop, user after login in the EVE will be forced to use selected Console Type. If Console Type is set to "any", user is able to choose Console type on Login page which Console will be used.

Role*

Console

- any
- native
- html5
- Desktop

To

RAM (GB)

Step 7: **Assigned single Lab.** Applies for **User role** only. Set the specific Lab for the user "assigned/sticky lab". After login in the EVE User will directed only to this lab. He cannot close the lab to get in main Lab management page. User can Start/Stop/Wipe lab, as well save his lab work on the lab devices. Follow Section: **7.3.1.5**

Role

Console

Lab

- None
- /Shared/001-Release-Lab-B.unl

Step 8: Satellites assignment per user (Editor or User) require Administrator account

The screenshot shows a dropdown menu titled 'Satellites'. The selected value is 'any'. The dropdown list contains three items: 'any' (checked), 'master', and 'SAT01B'.

The User Cluster Server value “any” is set by default.

Set the Cluster Satellites for the Lab Editor. This applies for Lab Editor roles. Lab Editor will stick to selected Satellites. Lab Editor will be forced and allowed to use only selected Satellite server or choose between the Satellite servers if it is assigned more than one server. If the Lab has set to use any satellite server, then Lab Editor will be assigned to use lowest satellite ID.

Example: If Lab Editor has assigned to use SAT1 (ID1) and SAT2 (ID2). The Lab has set to use “any” satellite. This Editor lab will be automatically assigned to use first available Satellite with lowest ID1, SAT1.

Editor has rights to change Satellite per node for *own created Labs*.

Editor cannot change satellite assignments for Shared Lab. The Shared Lab is recommended to set “any” Cluster Satellite,

If the Lab is created on the Satellite servers which are NOT in the Lab Editor allowed Satellites list, this lab will not start.

Example: If Lab is created to use Master server only, but Lab Editor is allowed to use only SAT1 Server. Lab Editor will not be allowed to start this Lab.

If the Lab contains nodes which are assigned to run on the Satellite server which is NOT in Lab Editor allowed Satellites list, this node will not start.

Example: If Lab several nodes are assigned to use Master server only, but Lab Editor is allowed to use only SAT1 Server. Lab Editor will not be allowed to start these nodes.

Set the Cluster Satellites for the Lab User. This applies for Lab User roles. Lab User will stick to selected Satellites. Lab User will be forced and allowed to use only selected Satellite server or servers.

Example: If Lab User has assigned to use SAT1 (ID1) and SAT2 (ID2). The Lab has set to use “any” satellite. This Lab User lab will be automatically assigned to use first available Satellite with lowest ID1, SAT1.

If the Lab is created on the Satellite servers which are NOT in the Lab User allowed Satellites list, this lab will not start.

Example: Lab is created to use Master server only, but Lab User is allowed to use only SAT1 Server. Lab User will not be allowed to start this Lab.

If the Lab contains nodes which are assigned to run on the Satellite server which is NOT in Lab User allowed Satellites list, this node will not start.

Example: Lab several nodes are assigned to use Master server only, but Lab User is allowed to use only SAT1 Server. Lab User will not be allowed to start these nodes.

User Profile and Lab nodes Satellite use hierarchy

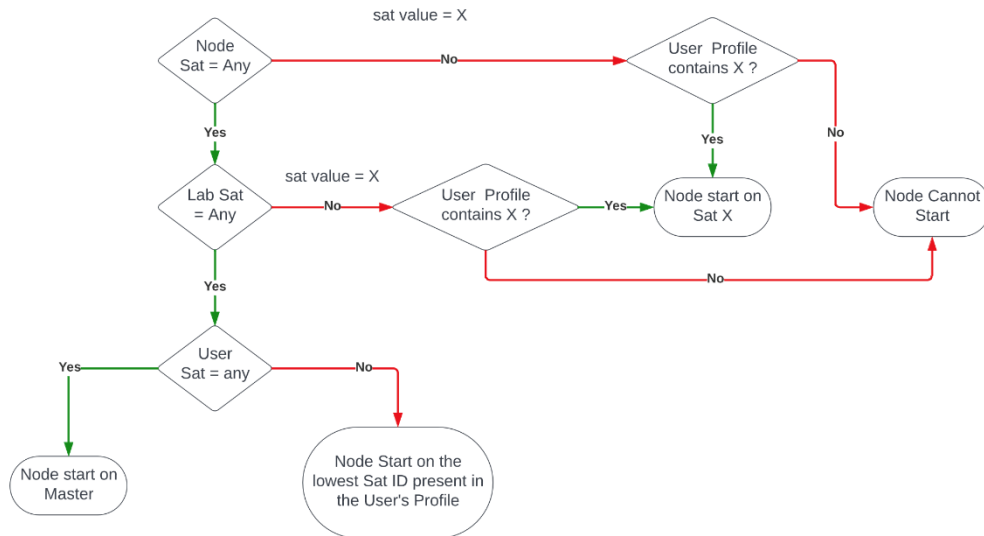

Step 9: User time access to the EVE server.

- EVE-NG Users time database is using UTC time zone. To convert user time zone to the UTC, please use online time convert <https://dateful.com/convert/utc>

UTC Time Zone Converter

08:09	NEXT DAY	22:09
UTC		Honolulu HST

- Set the access date and time in UTC timezone From - To. If the fields are left empty (untouched), your user will have no time restrictions for accessing the EVE Server. *Account validity with time settings is available for Editor and User roles only.*
- Admin accounts have no time limit for account validity and resource, and Account Validity time or resource cannot be set.
- To remove date/time: Delete date, esc, type value “-1”

Account Validity

From To

POD*

Step 10: The POD number is a value assigned to user accounts automatically. POD numbers are like user profiles inside of EVE and are a unique value for every user Think of PODs like a virtual rack of equipment for each user. Admins can assign a preferred number between 1-32786. Please keep POD numbers unique between users!

Step 11: Set user limitation to use eve resources. “-1” value is unlimited EVE resource. Only Editor and User roles can be set for EVE resource limitation, Quota.

Example: editor user is allowed to run/create labs for x4 CPU and 8Gb RAM.

Quotas

CPU RAM (GB)

In case of violation these settings, user will receive alert message:

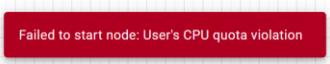

Step 12: Press Save for add user or confirm edited user settings.

7.3.1.2 Edit EVE User

Step 1: Open the User management submenu. Management -> User management and choose which user you want to edit.

Username	Status	Authenticator	Email	Name	Role	Sat	Disk Usage	Start Date	Expiration	Max RAM (GB)	Max CPU	POD	Lab	Actions
admin	Online	internal	root@localhost	Eve-NG Administrator	admin	any	0 Gb			Unlimited	Unlimited	0	None	edit add del
test2	Offline	internal	uidis.dzorkais@gmail.com	Lab Editor 2	editor	any	0 Gb			Unlimited	Unlimited	1	None	edit add del
test3	Offline	internal	uidis.dzorkais@gmail.com	Lab Editor 3	user	any	0 Gb			Unlimited	Unlimited	2	None	edit add del

Step 2: The Edit user management window will pop up. Now you can edit necessary user information, roles, or access time. Confirm settings by pressing Save at the bottom of the window.

Edit User

User Name*

Password

Confirm Password

Authentication

Email

Name

Use only [A-Za-z0-9_~]chars

Role

Console

Lab

Satellites

Account Validity
From To

POD*

Quotas
CPU RAM (GB)

SAVE **CANCEL**

7.3.1.3 User session termination

Administrator has rights to terminate active user session to the EVE server. Press Kick to disconnect user from EVE HTML session.

User Management ADD USER MORE INFO

Username	Status	Authenticator	Email	Name	Role	Sat	Disk Usage	Start Date	Expiration	Max RAM (GB)	Max CPU	POD	Lab	Actions
admin	Online	Internal	root@localhost	Eve-NG Administrator	admin	any	0 Gb			Unlimited	Unlimited	0	None	  
test2	Offline	Internal	uidis.dzerkalis@gmail.com	Lab Editor 2	editor	any	0 Gb			Unlimited	Unlimited	1	None	  

7.3.1.4 User monitoring

There is a dropdown menu next to “Add User” called “More Info” that can provide additional information about your users. Click the checkbox next to the relevant information that you would like displayed. Additional columns will be added for each checkbox that is chosen. Red or Green label will show user status, which is logged or not in the EVE.

User Management ADD USER MORE INFO

Username	Status	Authenticator	Email	Name	Role	Sat	Disk Usage	Start Date	Expiration	Max RAM (GB)	Max CPU	POD	IP Address	Folder	Lab	Session	Additional Fields
admin	Online	Internal	root@localhost	Eve-NG Administrator	admin	any	0 Gb			Unlimited	Unlimited	0	10.51.51.18	/	None	21/04/2025	<input checked="" type="checkbox"/> IP Address <input checked="" type="checkbox"/> Folder <input checked="" type="checkbox"/> Lab <input checked="" type="checkbox"/> Session
test2	Offline	Internal	uidis.dzerkalis@gmail.com	Lab Editor 2	editor	any	0 Gb			Unlimited	Unlimited	1	10.51.51.18	/	None		
test3	Offline	Internal	uidis.dzerkalis@gmail.com	Lab Editor 3	editor	any	0 Gb			Unlimited	Unlimited	2	10.51.51.18	/	None		

Items per page: 10 1-3 of 3

7.3.1.5 User role assigned lab

Assigned Lab. Applies for **Lab User role** only. Set the specific Lab for the user, “assigned/sticky lab”. After login in the WEB, EVE User will direct only to this lab. He cannot **close** the lab to get in main Lab management page. User can Start/Stop/Wipe lab, as well save his lab work on the lab devices. On the Lab user has logout from EVE-NG account option only.

Pre-requisites for this feature: The user must be created before. It must exist in EVE database. Only then use Edit user and set desired Assigned/Sticky lab. For Lab selection from the list, the Lab must be upload in the **Shared folder** by admin first. If Lab Menu is selected to “None”, User can close the Lab and open another shared Lab for him. The value “None” is set as default.

Edit User

User Name*
test3

Password
.....

Confirm Password
.....

Authentication
internal

Email
test3@eve-ng.net

Name
Lab User 3

Use only [A-Za-z0-9_].chars

Role
Lab User

Console
any

Lab
/Shared/001-Release-Lab-B.unl

Satellites
any

Account Validity
From: DD/MM/YYYY To: DD/MM/YYYY

POD*
2

Quotas
CPU: -1 RAM (GB): -1

SAVE CANCEL

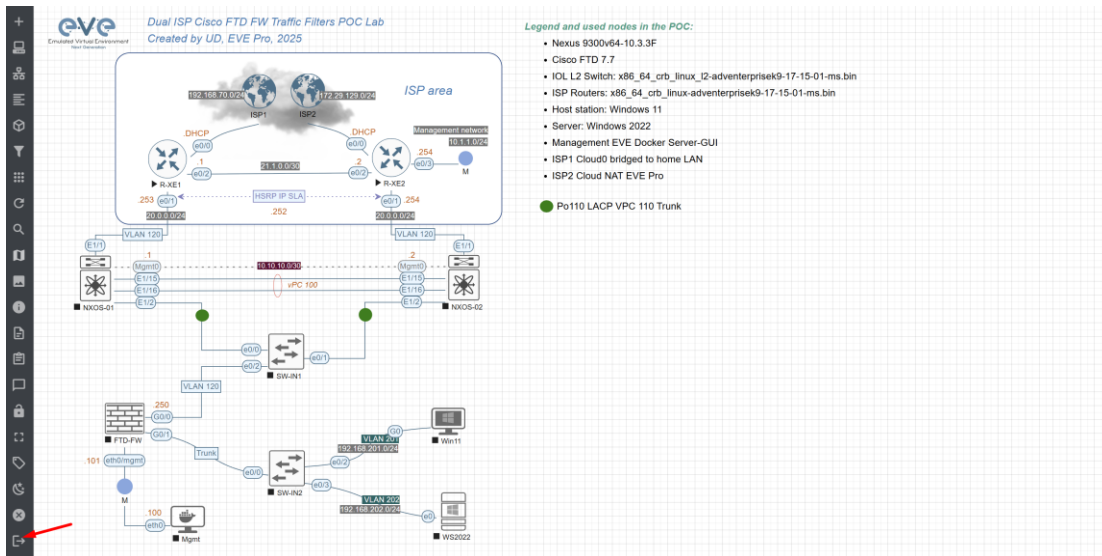

7.3.2 EVE Node management

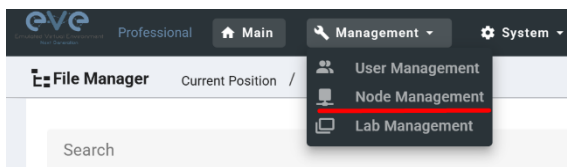

The Management dropdown has a submenu called “Node Management.” The Node management menu displays all currently running nodes within EVE. Within this menu, an Admin account can manage or even console to any user’s nodes.

- ⚠ **NOTE:** Editor and User accounts are able to see and open console sessions to their own running nodes only
- ⚠ **NOTE:** Admin accounts are able to see and open console session to all users running nodes

Lab Name	Lab ID	Username	Satellite	Node Name	CPU	RAM	Disk	Template	Actions
001-Release-Lab	1	admin	master	Mgmt	0.13%	0.29GB	0.000GB	docker	[Console] [Stop]
001-Release-Lab	1	admin	master	R.XE1	0.13%	0.53GB	0.001GB	iol	[Console] [Stop]
001-Release-Lab	1	admin	master	R.XE2	0.13%	0.53GB	0.001GB	iol	[Console] [Stop]
001-Release-Lab	1	admin	master	SW-INT	0.13%	0.45GB	0.001GB	iol	[Console] [Stop]
Users/test2/Shared/001-Release-Lab-B	3	test2	master	SW-INT	0.13%	0.45GB	0.001GB	iol	[Console] [Stop]
Users/test2/My Lab	2	test2	master	viOS1	2.25%	1.08GB	0.000GB	vios	[Console] [Stop]
Users/test2/My Lab	2	test2	master	viOS2	2.13%	1.08GB	0.000GB	vios	[Console] [Stop]
Users/test2/My Lab	2	test2	master	viOS3	2.25%	1.22GB	0.000GB	vios	[Console] [Stop]

7.3.2.1 Node management actions

Button	Action
	Open a console session to the running node

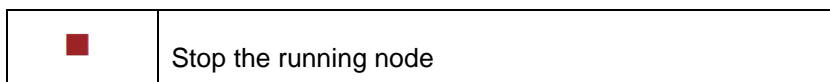

7.3.2.2 Node management filtering function

Each column in the Node Management Menu has a field or sort sign that will allow you to filter the list to only display information related to the entered value.

Example: Click on “CPU Usage” The CPU column will sort running nodes with most CPU consumption on the top.

Node Management									
Lab Name	Lab ID	Username	Satellite	Node Name	CPU	RAM	Disk	Template	Actions
Users/test2/My Lab	2	test2	master	vIOS3	1.88%	1.22GB	0.000GB	vios	[Stop] [Refresh]
Users/test2/My Lab	2	test2	master	vIOS2	1.75%	1.08GB	0.000GB	vios	[Stop] [Refresh]
Users/test2/My Lab	2	test2	master	vIOS1	1.63%	1.08GB	0.000GB	vios	[Stop] [Refresh]

Each column can be sorted alphanumerically by clicking on the column name.

Example: click on the column Username and EVE will sort all running nodes in alphabetic order by username.

Node Management									
Lab Name	Lab ID	Username	Satellite	Node Name	CPU	RAM	Disk	Template	Actions
001-Release-Lab	1	admin	master	SW-INT	0.13%	0.45GB	0.001GB	iol	[Stop] [Refresh]
001-Release-Lab	1	admin	master	R-XE2	0.13%	0.53GB	0.001GB	iol	[Stop] [Refresh]
001-Release-Lab	1	admin	master	Mgmt	15.00%	1.28GB	0.000GB	docker	[Stop] [Refresh]
001-Release-Lab	1	admin	master	R-XE1	0.13%	0.53GB	0.001GB	iol	[Stop] [Refresh]
Users/test2/Shared/001-Release-Lab-B	3	test2	master	SW-INT	0.13%	0.45GB	0.001GB	iol	[Stop] [Refresh]
Users/test2/My Lab	2	test2	master	vIOS3	1.63%	1.22GB	0.000GB	vios	[Stop] [Refresh]

7.3.3 EVE Lab management

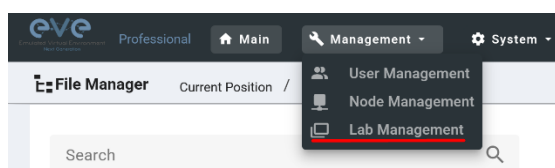

The Lab Management page, under the Management Dropdown, displays running or stopped labs for all users. In this menu an Admin account can manage or even open up any user’s running labs.

In the columns CPU and Memory usage will be displayed actual running lab CPU and RAM utilization.

- ⚠ NOTE: Only labs which are using space on EVE HDD will be displayed.
- ⚠ NOTE: Editor and User accounts are able to see and open their own running labs only
- ⚠ NOTE: Admin accounts are able to see, open, and join to any user’s running or stopped lab.

Lab Management

Lab Name	State	UUID	Satellite	Username	CPU (%)	Memory (GB)	Size (GB)	Actions
001-Release-Lab	Running	bfd2a5fe-f47f-4f7f-8f6a-bfdb585a498c	master	admin	0.38%	2.79GB	0.00GB	
Users/test2/My Lab	Running	f8dc65eb-7020-4bb8-aa64-70fdca7d2b7	master	test2	5.38%	3.37GB	0.00GB	
Users/test2/Shared/001-Release-Lab-B	Running	fda6f5fe-7bc3-4730-b9e1-155dea7dbc4c	master	test2	0.13%	0.45GB	0.00GB	

Items per page: 10 1-3 of 3

Several columns in the Lab Management Menu have a field that will allow you to filter the list to only display information related to the entered value.

Example: Enter username in the field to filter labs created by “admin”

Lab Management

Lab Name	State	UUID	Satellite	Username	CPU (%)	Memory (GB)	Size (GB)	Actions
001-Release-Lab	Running	bfd2a5fe-f47f-4f7f-8f6a-bfdb585a498c	master	admin			0.00GB	

Filter Username: admin

Items per page: 10 1-1 of 1

Example: Click State to sort running labs on the top.

Lab Management

Lab Name	State	UUID	Satellite	Username	CPU (%)	Memory (GB)	Size (GB)	Actions
001-Release-Lab	Running	bfd2a5fe-f47f-4f7f-8f6a-bfdb585a498c	master	admin	15.63%	2.79GB	0.00GB	
Users/test2/My Lab	Running	f8dc65eb-7020-4bb8-aa64-70fdca7d2b7	master	test2	5.00%	3.37GB	0.00GB	
Users/test2/Shared/001-Release-Lab-B	Running	fda6f5fe-7bc3-4730-b9e1-155dea7dbc4c	master	test2	0.13%	0.45GB	0.00GB	
001-Release-Lab A3	Stopped	51ed2092-a124-42e0-a384-4a215e9958f5	master	admin	0.00%	0.00GB	0.00GB	

Items per page: 10 1-4 of 4

Example: Click on “Disk Usage” sorting labs with most HDD usage on the top

Lab Management

Lab Name	State	UUID	Satellite	Username	CPU (%)	Memory (GB)	Size (GB)	Actions
01-CAT9000-SGT-FTD	Stopped	b01e3b24-fe5a-497f-aca9-2187fbf8c6bf	master	uldis	0.00%	0.00GB	139.93GB	
02-IOL-SGT-FTD	Stopped	56f8873c-fd43-4029-9f07-58a06d7a1a72	master	uldis	0.00%	0.00GB	204.93GB	
A1 Test Labs/001 ICON TEST	Stopped	3d91f262-90bc-409d-b18f-3e1e476d0663	master	uldis	0.00%	0.00GB	2.28GB	

7.3.3.1 Lab management actions

Button	Action
	Open the running or stopped lab.
	Stop the running lab. The running labs will be displayed on top of list.
	Wipe lab. Clean up HDD space. NOTE: this action will delete saved lab configurations.

Once an admin has opened another user's running lab, that user's username will be displayed at the top of the left menu to help the admin keep track of which user's lab was opened.

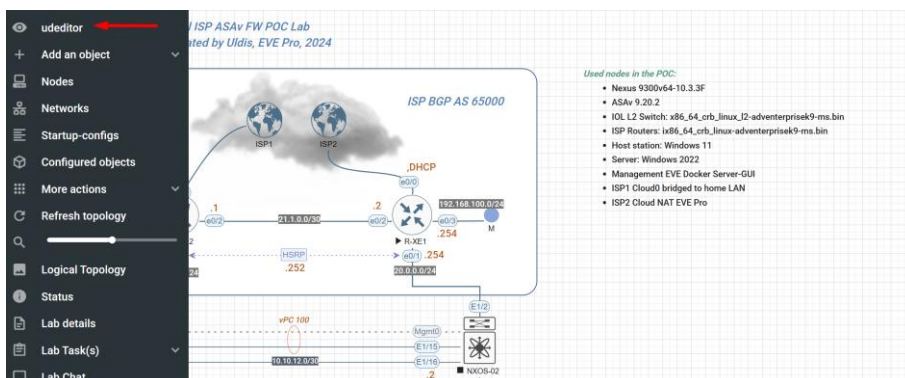

7.4 EVE System Dropdown menu

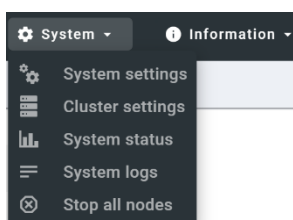

The EVE System dropdown contains the system settings, Cluster Management, system utilization status, log files, and an option to stop all running nodes on the server.

7.4.1 System Settings

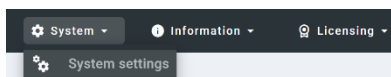

The System Settings page, under the System Dropdown, will show EVE System settings for:

- Cluster Network.** EVE-NG cluster members VPN network, used for intercommunication between EVE-NG cluster members. Customizable, please, change the first three octets to your preferred network. Format of network **A.B.C.0/24**. **The mask /24 is hardcoded.** (Value example: 192.168.90.0). The master EVE server IP of wg0 interface will be assigned: **A.B.C.254**. Rest Cluster members IPs of wg0 interface will be assigned accordingly EVE satellite ID, First EVE satellite ID1 IP

will be **A.B.C.1**. **NOTE, after changes of this network, the whole EVE cluster members reboot is required!**

- **Docker Network.** EVE-NG Dockers network. Used for dockers and docker consoles. Customizable, please, change the first two octets to your preferred network. Format of network **A.B.0.0/24**. **The mask /16 is hardcoded.** (Value example: 172.18.0.0). The master EVE server IP of docker0 interface will be assigned: **A.B.C.1** **NOTE, after changes of this network, the whole EVE cluster members reboot is required!**
- **NAT Network.** EVE-NG NAT Network, “Natting” internal EVE NAT network to the management pnet0/cloud0 EVE management interface IP. Used to have Internet in the labs with different network. DHCP service is enabled on this interface automatically. Customizable, please, change the first three octets to your preferred network. Format of network **A.B.C.0/24**. **The mask /24 is hardcoded.** (Value example: 192.168.100.0). The gateway and DNS IP of the NAT network interface will be assigned: **A.B.C.254**. **NOTE, after changes of this network, the master EVE server reboot is required!**
- External **Radius Server**, IP port and shared secret key
- **Active Directory** Authentication support
 - ✓ IP address of AD and port 389 or 3268 (TLS)
 - ✓ For TLS Active directory communication option, select **TLS**
 - ✓ DN: Example if domain is **eve.lab**, then DN syntax is: **dc=eve,dc=lab**
 - ✓ EVE-NG Active Directory Group: Example: EVE Users. EVE will search Your Group name in whole domain folder tree.

RADIUS Settings

Primary Server

192 . 168 . 70 . 201 Port 1812 Secret

Secondary Server

0 . 0 . 0 . 0 Port 1812 Secret

Active Directory Settings

Server

192 . 168 . 70 . 200 Port 389 TLS

Base DN

dc=eve,dc=lab

Active Directory Group

EVE Users

Note: The username in the Active directory user account must match with AD username. Username must have domain at the end of username.
Example:
aduser@eve.lab

Add User

- **Proxy server** IP and port, for authenticated proxy use username and password
- **Template visibility** is default settings for templates list on topology. Hide state will not show on topology Nodes list with unloaded images. In the Nodes list will appear only uploaded images. Show state (default) will show all available image templates.

Add Node

- **License check** is value where you can set EVE user session login behave.
 - ✓ The Value **Strict** does not allow user login if all available licenses have active sessions (screenshot below, Insufficient Licenses). If user has finished work with EVE server and closed browser, EVE server will clear this user connection session automatically after 1 minute.
 - ✓ The **Auto logout** will terminate oldest connected user session to the EVE server.

License Check

User's login control

Strict

Strict

Auto logout

Note: Administrator has rights terminate any user session, please refer Section: **7.3.1.3**

- **Disk critical size** is value when EVE will start alert you about HDD space limit is reached. If you will set 5Gb value, your EVE will start show warning messages in notification area. The formula in Linux how to set desirable threshold is: $[Your\ full\ HDD\ size] * 5\% + [desirable\ size\ in\ GB]$.

Disk Critical Size
Minimal free space (GB)

Blinking Warning
right bottom



⚠ Low Disk Space Warning!
 Available: 3166.9279GB | Used: 1892.9205GB | Minimum Required: 2201GB
 Available space (3166.9279GB) minus used space (1892.9205GB) is less than minimum required (2201GB)

DISMISS

- Example: $500GB * 5\% + 10GB = 35GB$ value of must be set for 10GB threshold.

- **HTML5 Terminal settings** Option to change console colour scheme, fonts, font size and backgrounds.

HTML5 Terminal Settings

Color scheme: Font name: Font size:

Management Interface Settings

Enable IPV6

- **Management interface settings** Option to enable IPv6 on the EVE Management interface

- **WEB Service caching.** Option to enable WEB caching EVE for Management interface

Web Service Settings

Enable caching

- **Disk I/O strategy.** Activate caching for qemu virtual disk read/write. Recommended for Intel CPU models with SGX extension.

Disk I/O strategy

Enable disk caching

- **Realtime Traffic Update** time in which your web browser updating live traffic feeding.

Realtime Traffic Update

- **Lab Node Start Parallelism**

Number of nodes started in parallel from the lab (Start All / Start Selected). Maximum is 50% of node CPUs (server-calculated).

3 / 12

- **CPU/Memory Settings** dedicated cores for EVE services. Suitable for EVE machine with more than 8 vCPU cores. Select the dedicated amount of CPU cores for system use.

CPU/Memory Settings

Dedicated CPU for Services (Reboot required)

- CPU NUMA Balancing enables or disables CPU NUMA balancing settings. Suitable for EVE machines with up to x6 vCPU cores. If your EVE has 8 or more vCPU cores **disabling** this option will force to use of CPUs if full scale and you will achieve better and more nodes to start in your labs.

Numa Balancing

7.4.2 Cluster Management

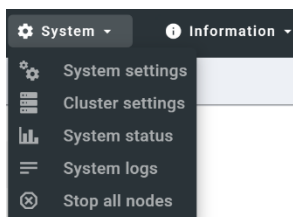

The Cluster Management page, under the System Dropdown, will show Cluster Management options, and cluster members resources utilization. Please refer to Chapter EVE Cluster System [15](#)

7.4.3 System status

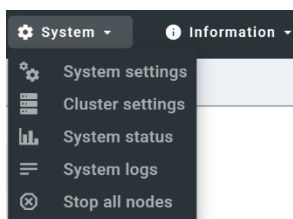

The System Status page, under the System Dropdown, will show EVE server resource utilization, the number of running nodes per template, current running versions of EVE and the current status of the UKSM and CPU Limit options.

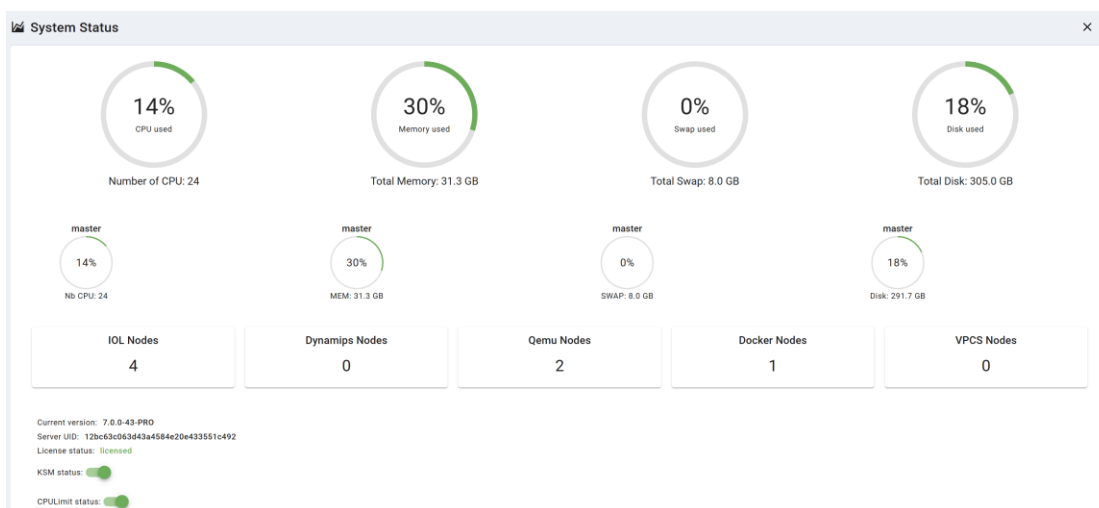

KSM – “KSM (kernel same-page merging) is a Linux kernel feature that allows the KVM hypervisor to share identical memory pages among different process or virtual machines on the same server.” It can be disabled globally for EVE on this page. It is recommended to keep KSM **enabled**.

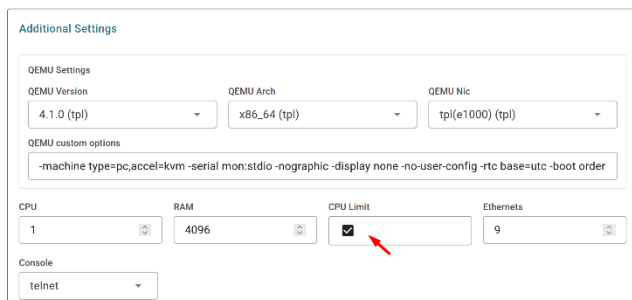

CPU Limit – CPU limit is used to limit CPU overloads during the nodes run time. It acts like a smart CPU usage option. If a running node reaches 80% CPU utilization, the CPU Limit feature throttles CPU use for this node to 50% until process usage drops under 30% for a period of 1 minute.

It is recommended to keep the Global CPU Limit option enabled.

CPU Limit can be turned for individual nodes in a lab. EVE node templates are set, by default, with the recommended CPU limit settings. An Unchecked CPU Limit option means that this node will boot without CPU limit.

Reference:

<https://searchservervirtualization.techtarget.com/definition/KSM-kernel-samepage-merging>

7.4.4 System logs

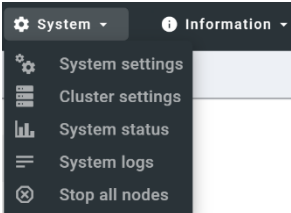

The System logs page, under the System Dropdown, will display EVE server log information

In the menu you can select a specific log file for inspection.

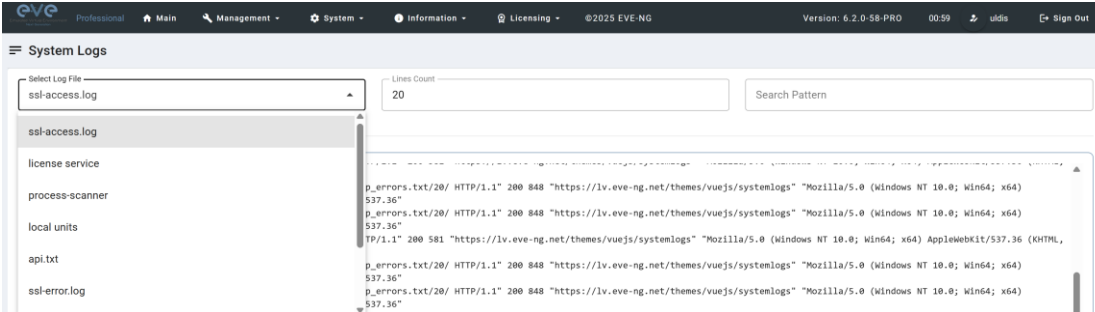

7.4.5 Stop All Nodes

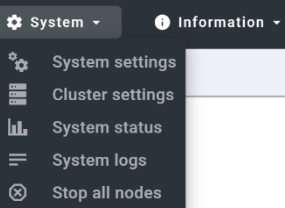

The Stop All Nodes option, under the System Dropdown, is an option that stops all running nodes on the EVE server. This option is accessible only by Admin users.

Same can be achieved issuing cli command:

```
/opt/unetlab/wrappers/unl_wrapper -a stopall
```

7.5 EVE Information Dropdown menu

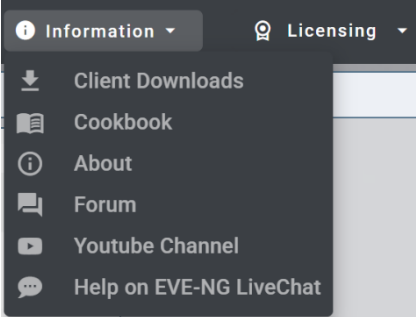

The Eve Information Dropdown contains links to the Local latest Local Console Client packs download, EVE Cookbook, EVE Website, EVE forum, EVE YouTube channel, and the web-based EVE Live Help chat.

To join the EVE Forum, in order to make posts or download materials, a forum user account must be created.

To join the EVE Live Chat for support, please use your Google account for access, or create a new user account

for this chat. Please note the forum and live chat use separate user accounts.

7.6 EVE Licensing Dropdown menu

The EVE Licensing dropdown contains options for managing your EVE license.

The License Information Window will display the expiration date along with the number of licenses that have been activated

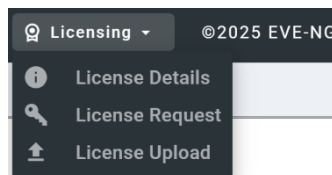

License information display:

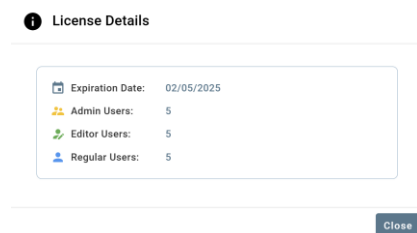

For License Request and License Upload, please refer to section 4.5 for more information.

7.7 Other Tab line info

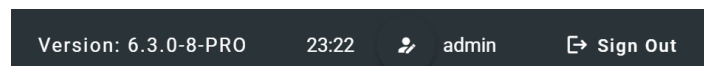

Other items on the top menu are: Current version of EVE-NG, Real-time clock, a shortcut to edit the currently logged in user, and a sign-out button.

7.8 Lab preview and global settings

Once you click on a lab in the folder tree, a main window on the right side will display schematic content of the lab as well as lab management options like open, edit, and delete.

The actual lab topology appears after 1-3 seconds.

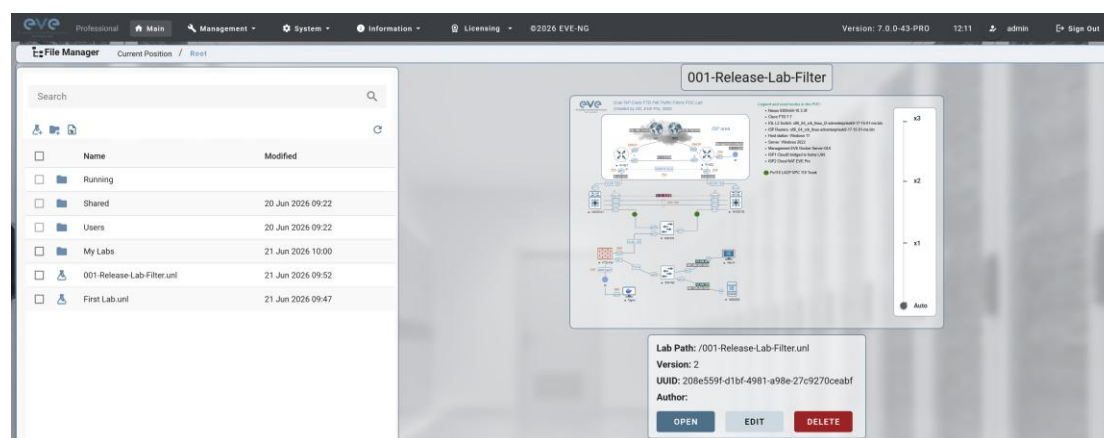

7.8.1 Lab preview window

The lab preview window displays the schematic position of nodes and their connectivity. The actual lab topology appears after 3-5 seconds. The Scale option allows you change the lab preview size.

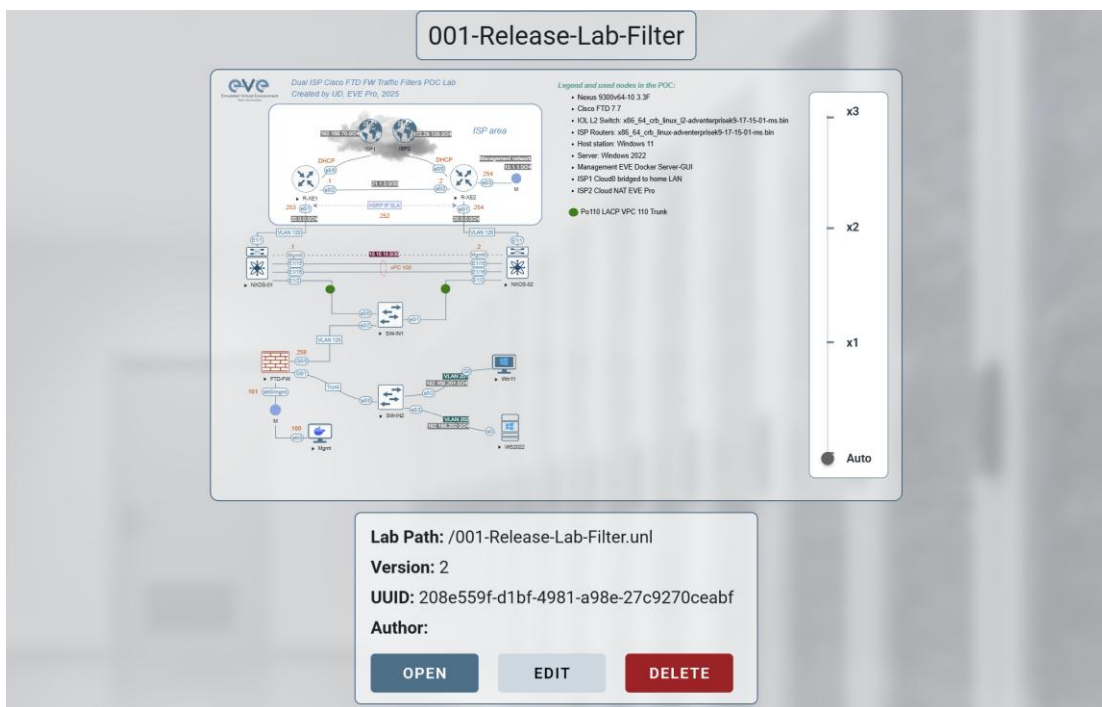

7.8.2 Lab preview buttons

In the lab preview, these buttons allow you to manage the selected lab.

Button	Description
OPEN	Opens the Lab to the Topology Canvas
EDIT	Opens the Labs Global Settings. Refer to section 7.8.4 for more info.
DELETE	Deletes the lab

7.8.3 Lab preview information

Description, version, UUID etc.

Lab Path: /test_lab1.unl

Version: 12

UUID: 95692558-5acb-4308-ab66-64f9b40bd31f

Author: John Tester

Description:



Here is short description of Lab

7.8.4 Lab properties

Lab Properties Page is opened when you click on the Edit  button below the Lab preview window.

Lab properties

Path: /001-Release-Lab.unl	Lab Description: 10.
Name: 001-Release-Lab 1.	
Version: 2 2.	
Author: 3.	
Satellite: any 4.	
Shared with: 5.	
Config Script Timeout: 300 6.	
Lab Countdown Timer: 0 7.	
Default link width: 1.5 8.	
Display Grid: <input checked="" type="checkbox"/> 9.	Lab tasks: 11.

This page allows you to fill out important information about the lab. The red numbers in the picture correlate with the numbers listed below

1. Lab name.
2. Version: Version numbers allow a lab author to assign a value to a unique state of a lab. Increase the number to correspond to new developments in the lab. If left unfilled, EVE will assign a value of 0 automatically.
3. Author: You can add a lab author name in this field
4. EVE Cluster Satellite choice. By default, EVE will assign a value of “any” automatically. For cluster hierarchy please follow: [Chapter 15.10](#)
5. Project/Lab sharing Feature, please follow [Chapter 8.11](#)
6. Config Script Timeout: It is the value in seconds used for the “Configuration Export” and “Boot from exported configs” operations. Refer to section [10.3](#) for more information.
7. Lab Countdown Timer: It is the value in seconds to provide a time limit (countdown timer) for completing a lab. Refer to section [10.4](#) for more information. Default Lab
8. Links width, you can set default thickness of links for whole lab.
9. Topology background grid on/off.
10. Description: In the Description field you can write a short description of the lab.
11. Tasks: In the Tasks field you can write the task for your lab.



The Lab details window can be opened from the Topology Canvas page sidebar during labbing, to read the Tasks for the lab.

LAB DETAILS

TEST_LAB1

ID: 95692558-5acb-4308-ab66-64f9b40bd31f

Here is short description of Lab

Here are tasks for your lab. Task 1, Please configure Routers with IP addressing Task 2. Configure IGP, EIGRP routing on all nodes Task 3. Configure windows Host to receive DHCP IP address

EVE WEB Topology page

Once you open a lab, the topology page with lab will be displayed..

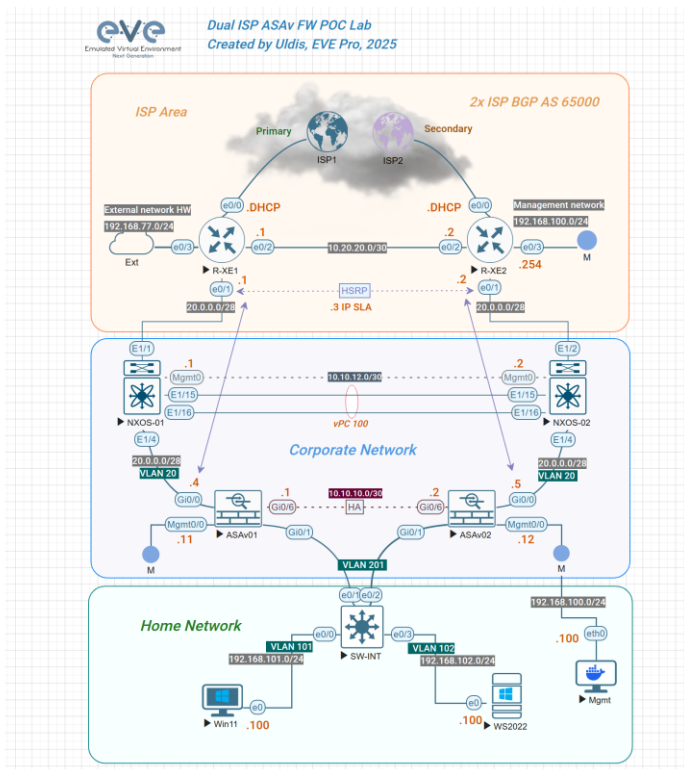

7.9 Side bar functions

Move your mouse pointer over to the left on top of the minimized sidebar to expand the interactive sidebar as shown in below screenshot

7.9.1 Add an object

The “Add an object” menu can be accessed in two different ways, from the sidebar and by right-clicking on the Topology Page

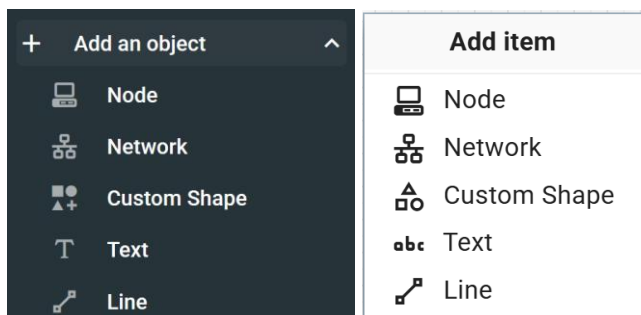

7.9.1.1 Node object

The Node object opens the “Add a new node” window. Only nodes that appear blue in the dropdown menu can be added. A grey image name signifies that you have not yet properly uploaded an image to the proper folder. A blue image name means that at least one image exists in the proper folder for this template. If the “Show unprovisioned templates” is checked, EVE will display unloaded image templates. To hide it, uncheck “Show unprovisioned templates” checkbox or follow section [7.4.1](#)

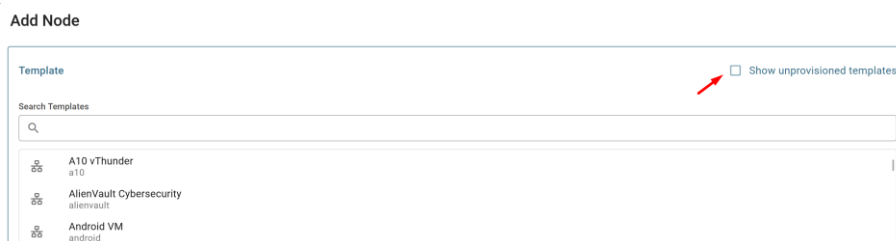

7.9.1.2 Network object

The Network object opens the “Add a new network” window. This function is used to add any kind of network (Cloud, Bridge or NAT). For details on these, please refer to section [9](#)

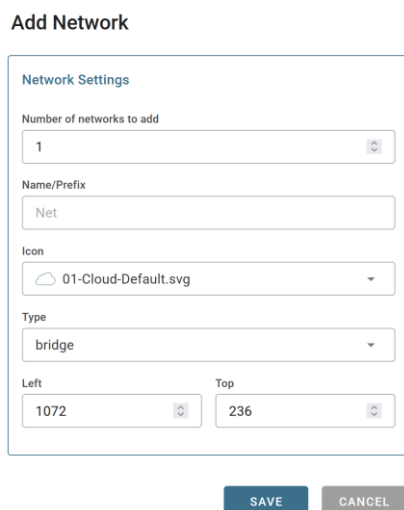

7.9.1.3 Custom shape object

The Custom shape object allows you to add shape elements onto the topology; these currently include squares, round squares and circles. For details, refer to section 10.1

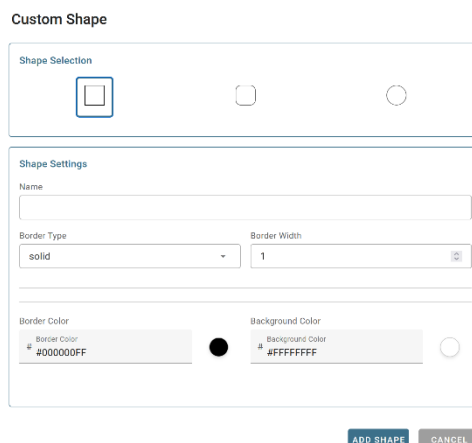
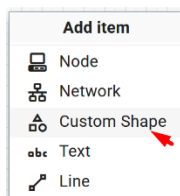

7.9.1.4 Text object

The Text object allows you to add MS Office elements onto the topology. For details, refer to section 10.1.3

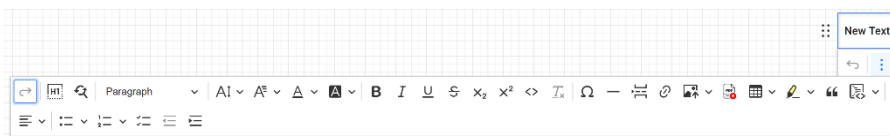
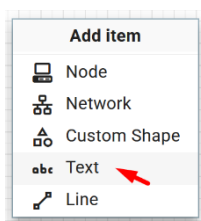

7.9.1.5 Line object

The Line object allows you to add line elements onto the topology; these currently include single arrow, double arrows and simple lines. For details, refer to section 10.1.6

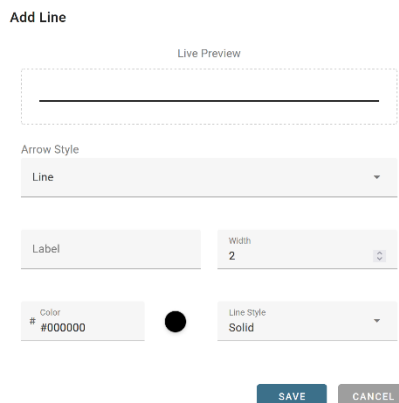
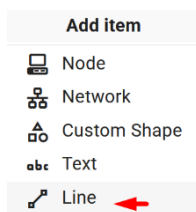

7.9.2 Nodes



The Nodes object in the sidebar opens the “Configured Nodes” window.

Configured Nodes Filter by Status: All

Lab Assigned Resources (Running/ Total) vCPU: 16/ 16 RAM: 59/ 59 GB HDD: 14.64 GB Total Resources: vCPU 112 - RAM 503.66 GB Showing: 10 of 10 nodes



ID	NAME	SATELLITE	TEMPLATE	BOOT IMAGE	CPU	CPU USAGE	RAM USAGE	CPU LIMIT	IDLE PC	ACTIONS
1	R-XE2	SAT01B	io1	x86_64_crb_linux-adventerprisek9-ms.bin	n/a	0.0%	17.0%	n/a	n/a	[Icons]
2	R-XE1	SAT01B	io1	x86_64_crb_linux-adventerprisek9-ms.bin	n/a	0.0%	16.7%	n/a	n/a	[Icons]
3	NXOS-01	master	nxosv9k	nxosv9k-9300v64-10.3.3F	2	39.6%	100.0%		n/a	[Icons]
4	NXOS-02	master	nxosv9k	nxosv9k-9300v64-10.3.3F	2	4.1%	51.7%		n/a	[Icons]
5	SW-INT	master	io1	x86_64_crb_linux_I2-adventerprisek9-ms.bin	n/a	0.0%	2.7%	n/a	n/a	[Icons]
6	ASAv01	master	asav	asav-9-20-2-21	1	13.0%	73.5%		n/a	[Icons]
7	ASAv02	SAT01B	asav	asav-9-20-2-21	1	0.0%	72.8%		n/a	[Icons]
8	Mgmt	master	docker	eve-gui-server:latest	2	0.0%	22.7%	n/a	n/a	[Icons]

In this window, you can make changes for nodes that are on the lab topology. More options can be found in the detailed node specific menu, for details refer to section 8.1.2.

- ⚠ NOTE: Running nodes are highlighted in Blue, their settings cannot be changed. You can only change settings of nodes that are not currently running.

You can change the following values:

- Node Name
- Boot image
- Number of CPUs for the node
- Live CPU usage
- Enable or disable CPU Limit (Refer to section 7.4.3)
- IDLE PC for Dynamips node
- NVRAM in Kbyte
- RAM in Mbyte
- Live RAM usage
- Ethernet quantity. **NOTE:** The Node must be disconnected from any other nodes to make this change. You cannot change the interface quantity if the node is connected to any other node.
- Serial interface quantity, IOL nodes only. You cannot change Serial interface quantity if the node is connected to any other node.
- Type of Console
- Node Icon that appears on the Topology
- Startup configuration to boot from

Actions Buttons (Stopped node):	Actions Buttons (Running node):
 <ul style="list-style-type: none"> • Start node • Edit node • Wipe node • Delete Node 	 <ul style="list-style-type: none"> • Console to the node • Stop node • Wipe node • Export the nodes config • Node details

7.9.3 Networks



The Networks object in the sidebar will open the “Configured Networks” window.

The “Configured Networks” window will only show networks that were specifically added to the topology; it will not show node interconnections. The example below is showing information for networks on the Topology. For Cloud networks and how to connect EVE labs to a network external to EVE, please refer to section 9

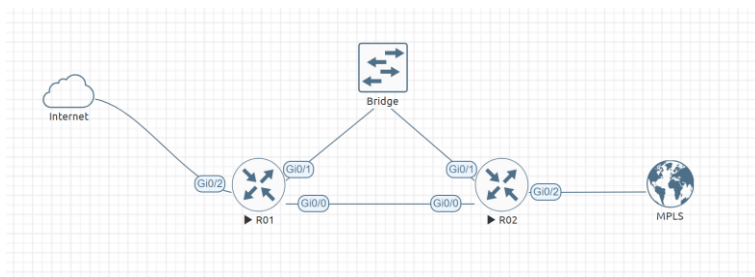

Networks

Network ID	Network Name	Network Type	Attached Nodes	Actions
1	ISP1	gnat0	1	
2	ISP2	nat0	1	
17	M	internal	1	
18	M	internal	1	
19	M	internal	2	
20	Ext	gnat2	1	

Items per page: 10 1-6 of 6

Actions

- Edit Network
- Manage Smart Switch or Internal/Private cloud, 802.1ad etc

Manage Network

Network Settings

Network ID: 17 Network Name: M

Smart Bridge Enable 802.1ad

Connected Interfaces

NODE ID	NODE NAME	INTERFACE ID	INTERFACE NAME	VLAN ID
6	ASAv01	0	Mgmt0/0	1
1	R-XE2	48	e0/3	1
7	ASAv02	0	Mgmt0/0	1
8	Mgmt	0	eth0	1

SAVE CANCEL

- Delete Network

7.9.4 Startup-configs

Startup-configs The Startup-configs object in the sidebar opens the “Startup-configs” window.

This window will show you startup-config for each node (for PRO it shows the startup configs of the current config set) and if the node is set to boot from it (ON) or not (OFF).

The “Startup-configs” window in the EVE Professional version contains additional features, please refer to section 10.3.

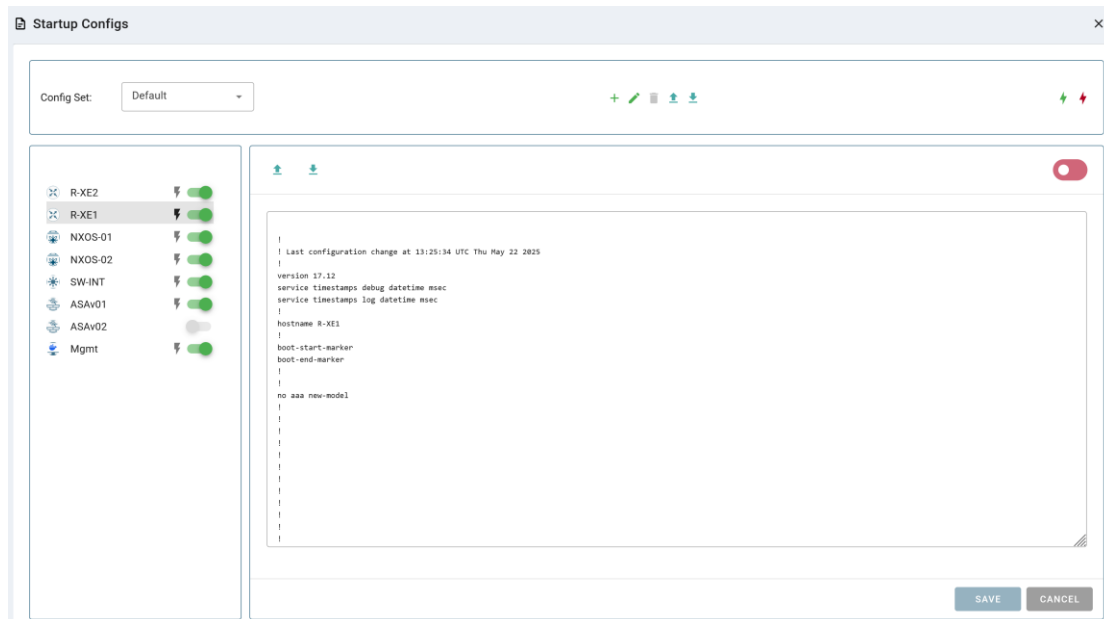

7.9.5 Configured Objects

Configured objects

The “Configured Objects” window will display a list of all objects that are added onto the topology. For details on different objects, refer to section 10.1

NOTE: You will not see any objects in this window if none have been added to the lab yet.

ID	Name	Type	Content	Actions
1	circle1	shape	○	✖
2	txt 2	text	vPC 100	✖

7.9.6 Traffic Filters

Traffic Filters

The “Configured Objects” window will display a list of all objects that are added onto the topology. For details on different objects, refer to section 11

7.9.7 More actions

The More actions menu in the sidebar has a submenu with the following functions.

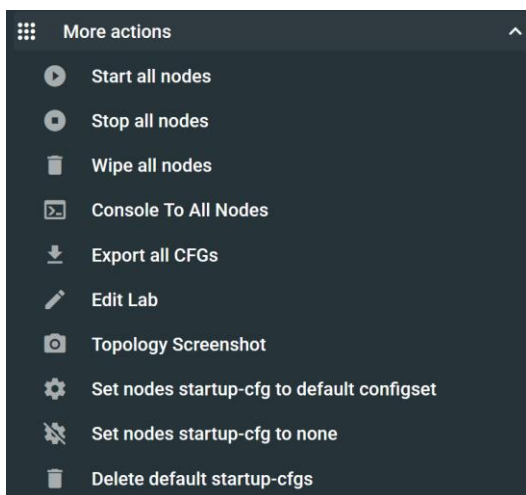

7.9.7.1 Start all nodes

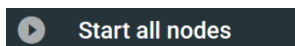

The “Start all nodes” action will start all nodes on your topology, taking the (configurable) startup delay of each node into consideration.

- ⚠ **IMPORTANT.** Starting many nodes at once can seriously spike your CPU utilization. Please make sure that you are not using the “Start all nodes” option for heavy labs or that you have configured a proper delay between the nodes. For heavy nodes and large quantities, it is recommended to start them in smaller groups, wait for them to finish booting and then start another small group of nodes.

7.9.7.2 Stop all nodes

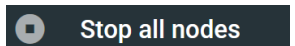

Stopping all nodes will power off all nodes on your topology.

- ⚠ **NOTE:** It is recommended to save your (running) configurations on the nodes in your lab before you stop the lab if you want to continue where you left off the next time. Stopping the nodes will leave the images in a temporary folder and will take up space on your drive until they have been wiped.

7.9.7.3 Wipe all nodes

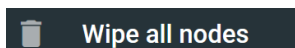

The “Wipe all nodes” action will wipe the NVRAM or currently saved image of all your nodes in the current lab.

Example: You have saved the nodes configuration by saving the running configuration to the startup configuration. The Wipe command will delete the saved NVRAM startup configuration and on the next boot it will boot from factory defaults.

The same applies to images without configurations, e.g. a linux node. If you make modifications to the system and afterwards wipe this node, the next time it will boot from the original base image again as the modified image was deleted.

The “Wipe node” action is commonly used with initial startup configuration modifications. The Wipe node action does not delete configured startup configurations or sets. Please refer to section [10.3](#)

7.9.7.4 Console to All Nodes

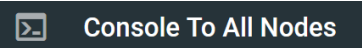
 “Console to all nodes” will open a console to all of your running nodes in the current lab. This includes all different kinds of configured console types for lab nodes like VNC, Telnet and RDP.

7.9.7.5 Export all CFGs

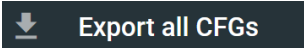
 The “Export all configurations” action will export current configs to the EVE startup-configs.

Export configurations are supported for:

Cisco Dynamips all nodes Cisco IOL (IOS on Linux) Cisco ASA Cisco ASA v Cisco CSR1000v Cisco Catalyst 9000v Cisco Catalyst 8000v Cisco Nexus 9K Cisco vIOS L3 Cisco vIOS L2 Cisco Viptela vEdge, vSmart, vBond, till version 18.4 only, version 19.x and later is not supported due implemented password setup feature on the first boot. Cisco XRv Cisco XRv9K	Juniper VRR Juniper vEX Juniper vRouter Juniper VMX Juniper vMX-NG Juniper vQFX Juniper vSRX Juniper vSRX-NG Mikrotik PfSense FW Timos Alcatel vEOS Arista Aruba CX Switch
---	--

For a full explanation of exporting configurations, please refer to section [10.3](#)

7.9.7.6 Edit lab

 Opens the Lab properties lab window. Refer to section: [7.8.4](#)

Lab properties

Path: /A1 Test Labs/001-Release-Lab.uni Name: 001-Release-Lab Version: 2 Author: Satellite: any Shared with: Config Script Timeout: 300 Lab Countdown Timer: 0 Default link width: 1.5 Display Grid: <input checked="" type="checkbox"/>	Lab Description: Test Lab for new icons and design Lab tasks: Configure lab <div style="text-align: right;"> <input type="button" value="SAVE"/> <input type="button" value="CANCEL"/> </div>
---	---

7.9.7.7 Topology screenshot

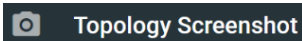

Topology Screenshot

Feature to export actual topology in png format

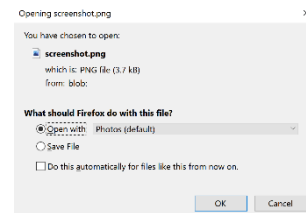

Screenshot Preview

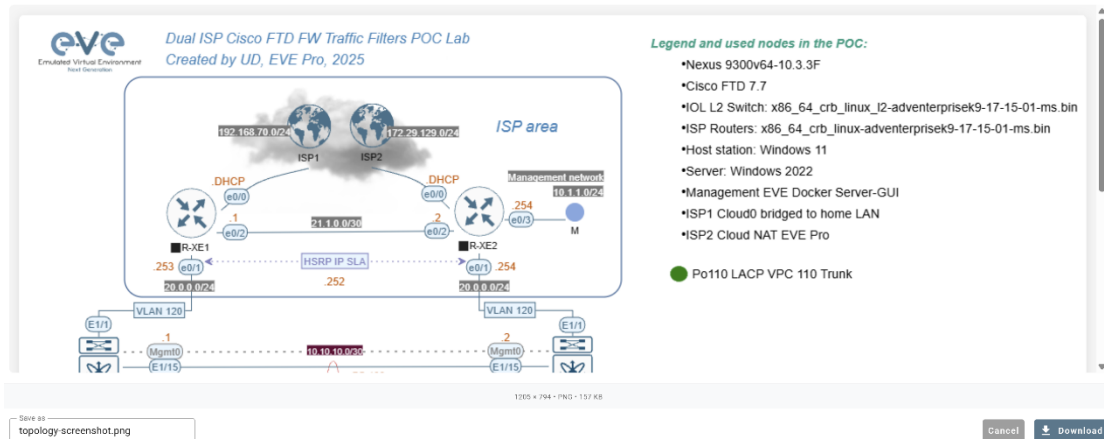

7.9.7.8 Set node's startup-cfg to default configset

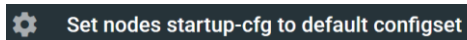

Set nodes startup-cfg to default configset

Sets nodes to the default startup-config. NOTE: If you have nothing saved in the default config set for any node, that node will boot from factory default instead. This is commonly used with the wipe node's function so the node will boot from the configured startup-config on next boot and not from the startup-config in its NVRAM in case the node was started before already.

Please refer to section [10.3](#)

7.9.7.9 Set node's startup-cfg to none



Set nodes startup-cfg to none

Setting all lab nodes to boot from factory default. Used commonly with the wipe nodes function. The example below shows the steps to set a lab to boot from factory default.

- Step 1: Wipe all nodes
- Step 2: Set all nodes to startup-cfg none

Please refer to section [10.3](#)

7.9.7.10 Delete default startup-cfgs

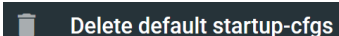

Delete default startup-cfgs

⚠ WARNING: this action will delete all configurations saved to your saved default config set. Please make sure that is what you want to do before you execute this.

7.9.8 Refresh Topology

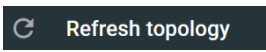

Sometimes it is necessary to refresh the topology if many objects are added on the topology.

7.9.9 Lab page zoom/unzoom



This action is used to zoom or unzoom a large topology in EVE.



Full screen zoom topology

The screenshot shows the EVE-NG interface with a sidebar menu on the left. The 'Refresh topology' option is highlighted. The main area displays a network topology diagram titled 'Cisco FTD FW Traffic Filters POC Lab'. The diagram includes two ISP clouds (ISP1 and ISP2) connected to a central management network. A legend on the right lists the nodes used in the POC:

- Nexus 9300v64-10.3.3F
- Cisco FTD 7.7
- IOL L2 Switch: x86_64_crb_linux_l2-adventerprise9-17-15-01-ms.bin
- ISP Routers: x86_64_crb_linux-adventerprise9-17-15-01-ms.bin
- Host station: Windows 11
- Server: Windows 2022
- Management EVE Docker Server-GUI
- ISP1 Cloud0 bridged to home LAN
- ISP2 Cloud NAT EVE Pro
- Po110 LACP VPC 110 Trunk

7.9.10 Lab Mini Map

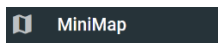

This action is used to see very large topology as mini map. On the right bottom corner, the whole topology is presented as mini map. You can select the parts of topology which you need to be displayed on the screen. Just click mouse pointer to the part on the mini map which you want to display on your screen. To disable this feature, simply click again on the side bar: MiniMap

The screenshot shows the EVE-NG interface with the 'MiniMap' option highlighted in the sidebar. The main area displays the same network topology diagram as in the previous section. A mini map of the entire topology is visible in the bottom right corner. The legend on the right is identical to the one in the previous section.

7.9.11 Logical Topology

Logical Topology

The Logical Topology object in the sidebar opens the “Logical Map Management” window.

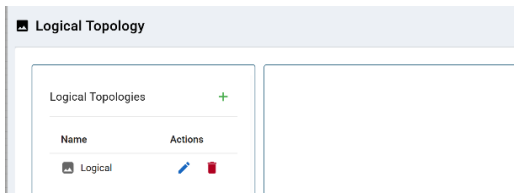

The Logical map object opens the “Add Picture” window and allows you to upload custom topologies in jpg or png format.

After uploading, you can edit these pictures and map selected areas to nodes from the topology to use your own designs as a lab topology from which you can directly connect to the nodes. Click on custom topology point.

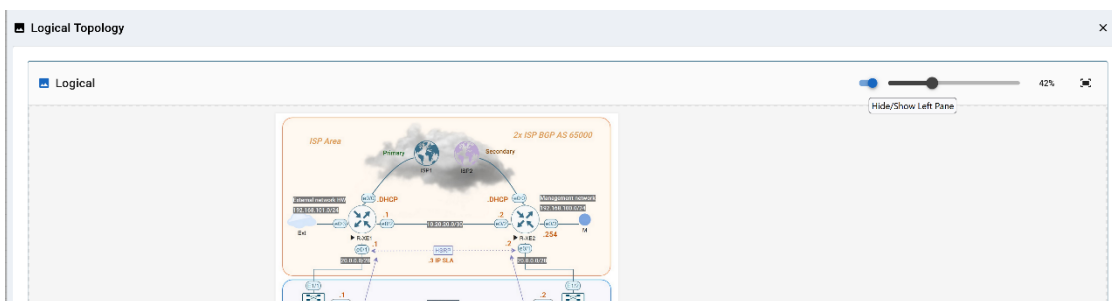

For details on the Logical Topology/ custom topology feature, refer to section [10.2](#)

7.9.12 Status

Status

Opens the EVE Status window.

Especially useful while working with labs to monitor your EVE's resource utilization. It shows EVE's CPU, RAM and disk utilization in real time. You can also see the number of running nodes per node type. For details on KSM and CPU Limit, please refer to section [7.4.3](#)

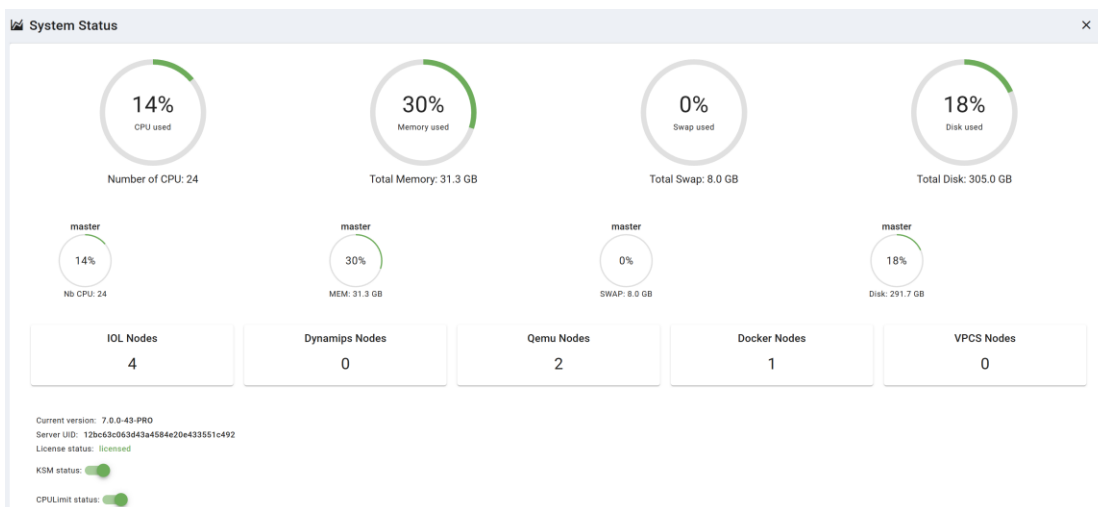

7.9.13 Lab details



7.8.4 and 7.9.7.6

Lab details display information about a lab, its UUID, description and lab tasks. To edit the lab description and lab tasks, please refer to section



7.9.14 Lab Tasks

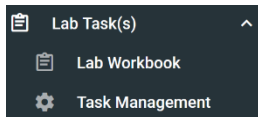

Opens a Lab Task feature. The EVE LabTasks is a feature that allows users (including admins and editors) to create task or workbook for the Labs. Detailed how to create lab workbooks please refer section 10.5

7.9.15 Lab Chat

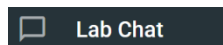

Opens a Lab chat session between users on the same EVE server. To activate the chat, click "Lab Chat" on the sidebar. To close and exit from the chat, click "Lab Chat" on the sidebar again. The EVE Lab chat is a feature that allows users (including admins/teachers) to communicate with each other during lab sessions.

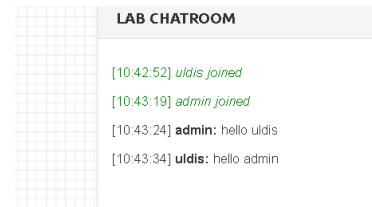

7.9.16 Lock Lab with password

"Lock Lab" disables some of the functions on the lab topology. If the lab is locked, you cannot move any node or object nor edit any node settings. Basically, the whole lab will be in read-only mode except for the lab settings itself, which you can still edit as Administrator or Editor from the main menu. The Lock Lab function is also used in conjunction with the countdown timer function, for details on this please refer to section 10.4

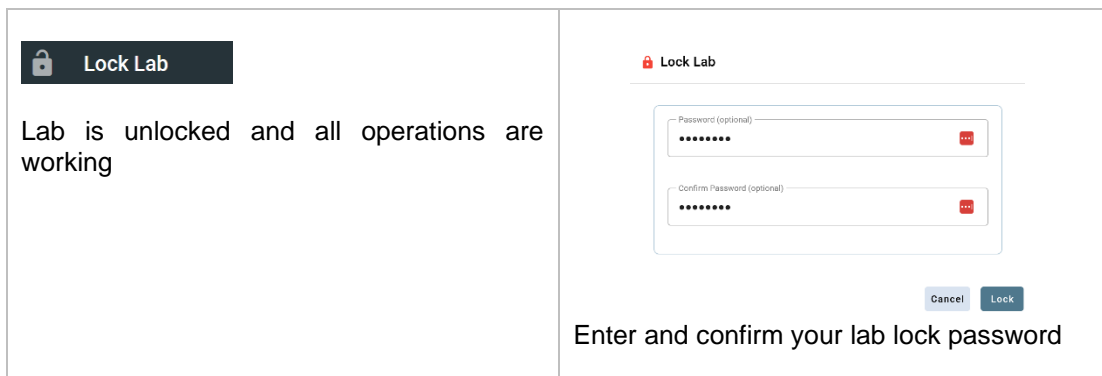

To unlock a Lab, simply press on the red “Unlock Lab” button with an Administrator or Editor account.

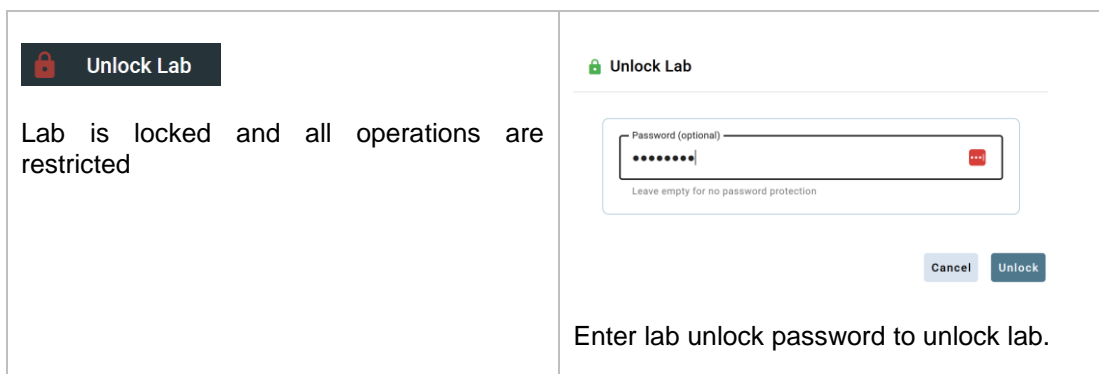

Warning: Please remember your Lab lock password. In case of a lost password, you will not be able to recover it. Unlocking a lab / removal of password can be done by EVE-NG support only.

7.9.17 Locked Labs Access rules

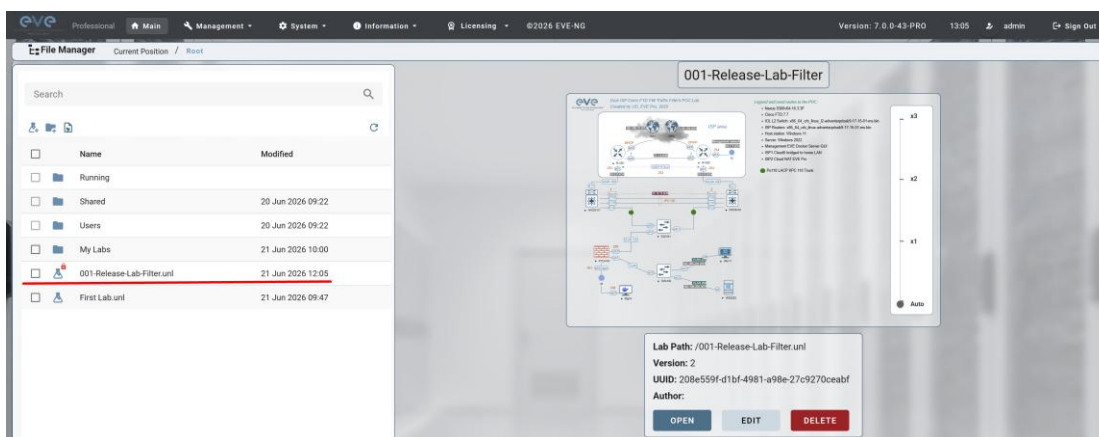

- ❖ Administrator CAN delete locked lab including shared folder. No unlock password is required.
- ❖ Lab Editor CAN NOT delete locked labs, including shared folder. Editor CAN unlock Shared folder Lab and delete it, if the unlock password is known.
- ❖ Lab User CAN NOT delete locked labs at any location.

7.9.18 Fullscreen



Fullscreen “Fullscreen” Fullscreen function is stretching your lab to the full monitor screen. To get back to normal web screen hit “ESC” or press “Fullscreen” again.

7.9.19 Hide interface labels

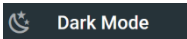

Hide interface labels for lab nodes	Show interface labels for lab nodes
-------------------------------------	-------------------------------------

7.9.20 Dark mode or Light mode

 <p>Sets your lab background to the dark mode</p>	 <p>Sets your lab background to light mode</p>
--	--

7.9.21 Close lab

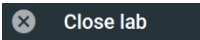
 Closes the lab topology. The lab can be closed while the nodes in the lab are still running as well. It will appear as running lab under the Running folder. Please refer to section [7.2.1.1](#)





7.9.22 Logout

 Log out from the EVE WEB GUI session.

7.10 EVE Lab topology menus

Right-clicking within the EVE topology can open new menus with various functions and options for managing nodes.

7.10.1 Lab topology menu

Add item	
 Node	Right-clicking on the (free/unused) canvas of the EVE topology opens a new menu. (Add-) Node, Network, Custom Shape, Text and Line are the same functions referred to in section 7.9.1 .
 Network	
 Custom Shape	
 Text	
 Line	
	Auto Align. This function will help align objects on the topology. The lab creator does not need to worry about small displacements of objects. Auto Align will align all objects to a virtual grid with a single click and can make neatly arranged labs look even neater.

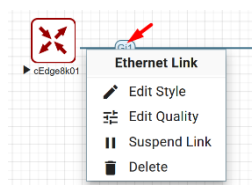

7.10.2 Connection menu



Right-clicking on the connection between nodes allows you to edit style, edit quality, suspend link and delete this connection.

7.10.3 Network Adding

Add item

-  Node
-  Network

When you have chosen Add a Network, the ADD A NETWORK window will open where you can change the placement, **network type** or name/prefix.

NOTE: You can add multiple networks (clouds) on your EVE topology, which will act as same cloud but in different locations on your EVE. Literally, like, the ethernet socket in the wall.

Add Network

Network Settings

Number of networks to add

Name/Prefix

Icon

Type

Left Top

7.10.4 Bridge or Internal network menu

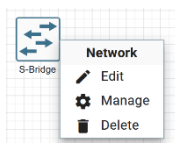

Right-clicking on a Bridge or Internal network allows you to Edit, Manage or Delete it.

If you have chosen Edit, the Network edit window will open a window where you can change the placement, name/prefix or icon.

For details on how to operate EVE Cloud networks and external connections, please refer to section 9

Edit Network

Network Settings

Network ID

Name/Prefix

Icon

Type

Left Top

Network Management

Network Settings

Network ID Network Name

Smart Bridge Enable 802.1ad

Connected Interfaces

NODE ID	NODE NAME	INTERFACE ID	INTERFACE NAME	VLAN ID
No interfaces connected to this network				

If you have chosen Manage, the Network Manage window will open a window where you can change Port assignments or protocol used for the bridge network.

For details on how to operate EVE Cloud networks and external connections, please refer to section 9

7.10.5 Cloud and Private network menu

When you have chosen Add a Network, the ADD A NETWORK window will open where you can change the placement, **network type** or name/prefix.

NOTE: You can add multiple networks (clouds) on your EVE topology, which will act as same cloud but in different locations on your EVE. Literally, like, the ethernet socket in the wall.

For details on how to operate EVE Cloud networks and external connections, please refer to section [9](#)

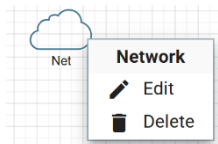

Right-clicking on a Cloud 0-9 and nat01 networks allows you to edit or delete it.

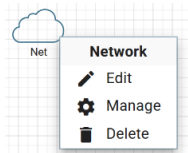

Right-clicking on a Cloud S-Bridge, Private or Internal networks allows you to edit, manage or delete it.

7.10.6 Stopped node menu

Right-clicking on a stopped node (grey) also opens a menu:

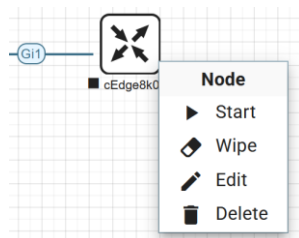

Start node: This will start the selected node in this lab

Wipe node: Wiping a node will erase the NVRAM (running config) or the temporary image snapshot depending on the type of node. This option is used to clean up a node in order to boot it from factory defaults or a custom set of configurations.

Edit node: Opens the Edit node window (picture on the right). For details, please refer to section [8.1.2](#)

Edit Node

Delete node. Deletes the node from the lab. It is recommended to disconnect (delete connections to it) the node before you delete it.

7.10.7 Running node menu

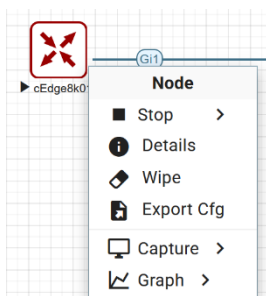

Right-clicking on a running node (blue) also opens a menu:

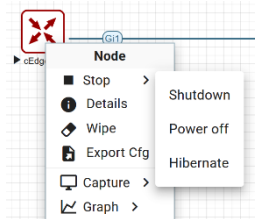

Stop. Blue arrow: clicking on Stop will stop the node depending on the method the node supports (power off / shutdown are auto-selected based on the template)

Stop menu. There are more options to stop a node, moving pointer on the chevron on the left side of “Stop” opens a submenu.

- **Shutdown:** Perform an orderly shutdown of the node if that node supports it (shutdown signal is sent down to the node)
- **Power off:** Kills the running nodes process within EVE (hard poweroff).
- **Hibernate.** Save Node state (Disk and Memory are saved in an internal snapshot). Used for fast boot of a node. The hibernation process can take some time. Once the hibernation process is completed, the node will turn grey (shutdown state).

Details: Details of running node template and graphical resource usage.

Node Details

The screenshot displays the 'Node Details' configuration interface. At the top, there are two performance graphs: 'CPU (100% = 1 CPU)' showing percentage usage over time, and 'Memory' showing usage in GB. Below the graphs is a 'Template' field containing 'catc8k'. The 'Main Settings' section includes fields for Instance Path, Image (catc8k-17.16.01a-universal), Icon (SDWAN-2D-cEdge-8k-S.svg), Name/prefix (cEdge8k01), Number of Nodes (2), Satellite (master), Delay (0s), Startup configuration (None), X Position (1136), and Y Position (276). The 'Additional Settings' section includes QEMU Settings (Version: 4.1.0 (tpl), Arch: x86_64 (tpl), Nic: vmxnet3 (tpl)), QEMU custom options (-machine type=pc,accel=kvm -cpu host -serial mon:stdio -nographic -no-user-config -nodefaults -rtc base=utc), CPU (2), RAM (8192), CPU Limit (checked), Ethernets (8), Console (telnet), and Additional Options (UUID: c61289a6-2115-4dc4-bc29-2b7fda520db3, First Eth MAC Address: 50:0a:00:0b:00:00). A 'CANCEL' button is located at the bottom right.

Wipe node: Wiping a node will erase the NVRAM (running config) or the temporary image snapshot depending on the type of node. This option is used to clean up a node in order to boot it from factory defaults or a custom set of configurations.

Export CFG: This function is used to export the saved running configuration to the EVE startup configuration sets. Reference section [10.3](#)

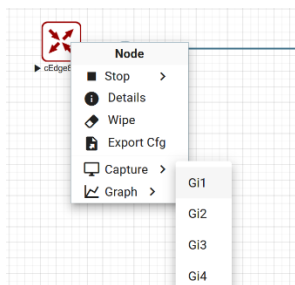

Capture. Integrated live Wireshark capture. Select the interface which you wish to capture. Reference section [10.5.4](#)

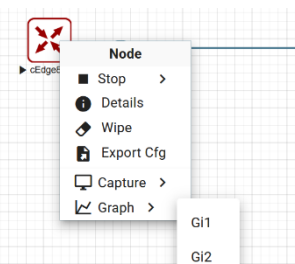

Graph. Integrated live interface activity monitoring. Displaying live interface utilization activity.



7.10.8 Selected nodes menu and features

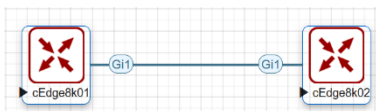

It is possible to select many objects or nodes at once in EVE. Using your mouse, you can select an area which will cover your nodes and/or you can click on nodes while holding the CTRL key on your keyboard.

A right-click on any of the selected nodes opens a group menu:

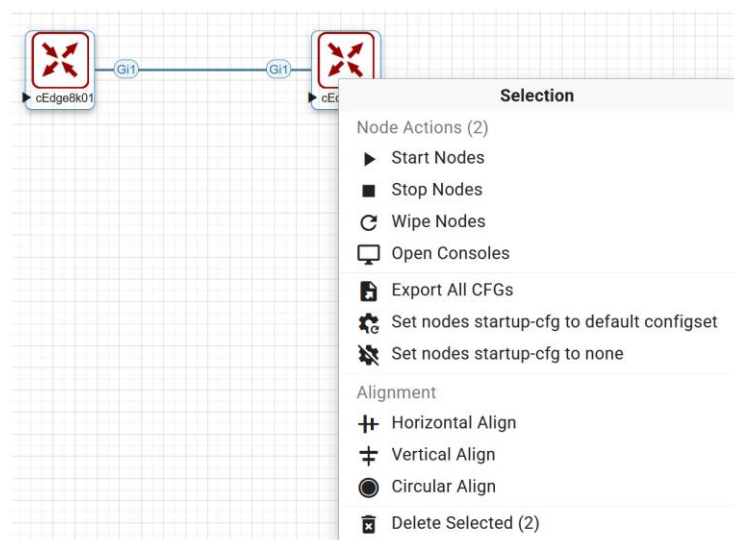

Start Nodes: This will start the selected nodes in this lab.

Stop Nodes: This will stop the selected nodes in this lab

Wipe Nodes: The Wipe Selected nodes action will wipe the NVRAM or currently saved image of the selected nodes in the current lab.

Example: You have saved the nodes configuration by saving the running configuration to the startup configuration. The Wipe command will delete the saved NVRAM startup configuration and on the next boot it will boot from factory defaults.

The same applies to images without configurations, e.g. a linux node. If you make modifications to the system and afterwards wipe this node, the next time it will boot from the original base image again as the modified image was deleted.

The Wipe node action is commonly used with initial startup configuration modifications. The Wipe node action does not delete configured startup configurations or sets. Please refer to section [10.3](#)

Open Consoles to Selected Nodes: Console to Selected Nodes will open a console to all selected running nodes in the current lab. This includes all different kinds of configured console types for lab nodes like VNC, Telnet and RDP

Export all CFGs: The Export all configurations action will export current configs of selected nodes to the EVE startup-configs.

For a full explanation of exporting configurations, please refer to section [10.3](#)

Set nodes startup-cfg to default configset: Sets nodes to Default startup config, used commonly with the wipe nodes function. NOTE: If you have nothing saved in the default config

set for any node, that node will boot from factory default instead. This is commonly used with the wipe nodes function so the node will boot from the configured startup-config on next boot and not from the startup-config in its NVRAM in case the node was started before already.

Please refer to section [10.3](#)

Set nodes startup-cfg to none. Setting selected lab nodes to boot from factory default. Used commonly with the wipe node's function. The example below shows the steps to set selected nodes to boot from factory default.

- Step 1: Wipe selected nodes
- Step 2: Set nodes startup-cfg to none

Please refer to section [10.3](#)

Horizontal Align. Aligns the selected nodes in one horizontal line.

Step 1: Select the nodes you wish to align.

Step 2: Right click on one of the selected nodes and choose Horizontal align, this will align all nodes to the selected node.

Picture before:

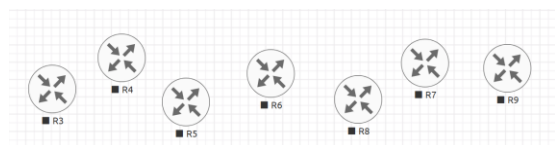

Picture after:

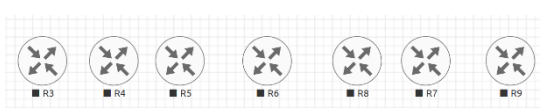

Vertical Align: Aligns the nodes in one vertical line.

Step 1: Select the nodes you wish to align.

Step 2: Right click on one of the selected nodes and choose Vertical align, this will align all nodes to the selected node.

Picture before:

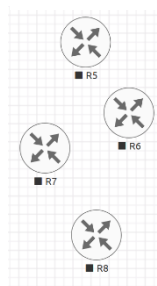

Picture after:



Circular Align: Aligns the nodes in a circle.

Step 1: Select the nodes you wish to align.

Step 2: Right click on one of the selected nodes and choose Circular Align, this will align all nodes in a circle, the midpoint of the circle will be at the coordinates the selected node was at before.

Picture Before

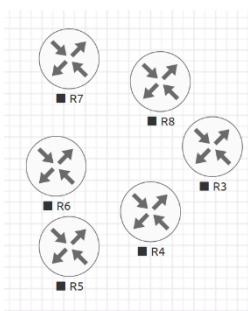

Picture After

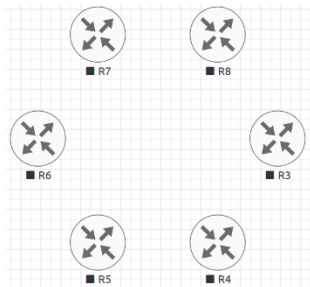

Delete nodes startup-config.

⚠ WARNING, this action will delete the configurations of the selected nodes that are saved to your Default config set. Please make sure that is what you want to do before you execute this.

Delete selected: This will delete the selected nodes from your current lab.

Selected nodes can be moved as a group across the topology.

Example: You can select nodes and objects to better position them on the Topology.

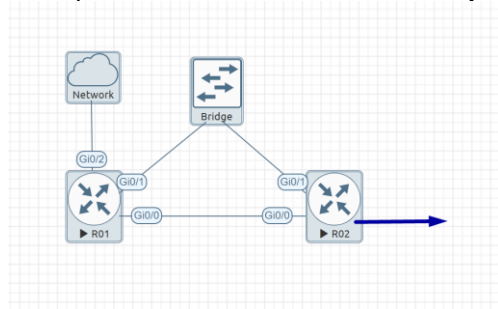

7.11 EVE Lab node states and symbols

7.11.1 Stopped (non-running) nodes



■ vIOS1

Grey colour and a square symbol below a node means that the node is stopped and not running. Once you will start it, the node will change to one of the running states below.



▲ vIOS

A grey node with an exclamation mark inside a triangle below the node means that there was a problem during the boot process, this could be a corrupted boot image, insufficient resources or problems with the initial configuration. A node in this state cannot be started again.

Workaround: Right-click on the node and wipe it, the symbol will then change to a grey colour with a square symbol below it. Then edit the node and make sure you have configured sufficient resources and the correct settings for this node, if it has startup-configs you can check them as well. Afterwards start the node again.

7.11.2 Running nodes



▶ vIOS2

The blue colour and black Play triangle symbol means that the node is started and running, the node is in a working/functional state.



A running node with a clock symbol below the node means that the node is waiting to finish loading from the set exported/startup configuration. Once the configuration has been successfully applied, the node symbol will change to a Play triangle symbol.



If the node has finished booting but the clock symbol does not change to the Play triangle symbol, the problem could be in the uploaded startup configuration. For how to use exported configurations and boot nodes from them, please refer to section **10.1**

A running node with a turning black gear symbol means that the node is either in the process of hibernating the node or it has sent the shutdown signal to the node and is waiting for it to turn off. Once this process has successfully finished, the symbol will turn into a grey node with a black square symbol below it (stopped state).

⚠ NOTE: If the node does not support a system shutdown or does not recognize the shutdown signal (example: Cisco router), after clicking on Shutdown, the node can stay with a turning red gear symbol below it indefinitely.

Workaround: Use Stop or Stop/PowerOff to stop the node.

Example nodes where Stop/Shutdown is supported: Microsoft Windows and most Linux nodes as well as a lot of appliances based on linux.

7.11.3 Node connector symbol



Connector symbol: If you move your mouse pointer on top of a running or stopped node, a yellow connector symbol appears. It is used to connect nodes on the topology in a drag and drop style.



Drag the symbol from one node and release the mouse pointer on the second node. A new window will appear where you can select the interfaces the link should connect to.

Create Link

cEdge8k01

Gi1

Gi1

cEdge8k02

Source node (cEdge8k01)

Choose Interface for Source

Gi1

Destination node (cEdge8k02)

Choose Interface for Destination

Gi1

Select Source Node interface which will be connected to the destination Node interface.

SAVE
CANCEL

7.11.4 Node icon resizing

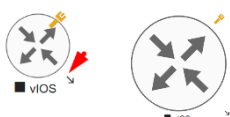

For resize node icon use right bottom arrow.

7.12 Other

7.12.1 Notifications area

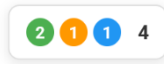

The Notification area in the top right is displaying informational or error messages.

Unwrapped notifications:

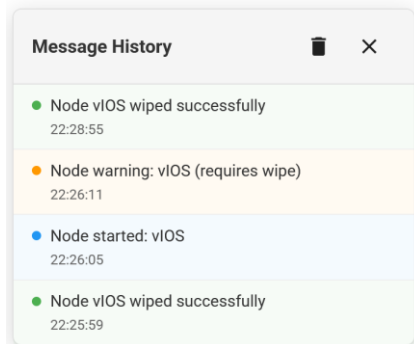

The Notification messages bar appears automatically for any EVE-PRO activity made on Topology.

	<p>Green: Success message counter. For review, expand notifications.</p>
	<p>Yellow: Warning message. For review, expand notifications.</p>
	<p>Blue: Operational message</p>
	<p>Close notifications bar. Note: Notifications bar appears automatically on any EVE topology activity.</p>
	<p>Delete notifications history</p>

8 Working with EVE labs

⚠ IMPORTANT NOTE: You must prepare and upload at least a couple of images to start building your labs. Refer to section [18](#)

8.1 Creating a lab

Step 1: Click Create new lab. For more information on creating new labs, please refer to section [7.2.2.1](#)



Step 2:

Fill out the lab information. Name and Version are required fields. Press Save. Refer to section [7.8.4](#) for more information about the different fields in the Edit lab window.

Create Lab

Path: / Name: My Lab 0003 Version: 01 Author: UD Satellite: any Shared with: Config Script Timeout: 300 Lab Countdown Timer: 0 Default link width: 1 Display Grid: <input checked="" type="checkbox"/>	Lab Description: Its my new project Lab tasks: 1. Configure IP addressing 2. Configure OSPF 3. Distribute default route in OSPF domain [SAVE] [CANCEL]
---	---

8.1.1 Adding nodes to the lab

The new Topology page will open. There are two different ways to add nodes to the topology canvas:

Step 1: Object/Add Node

<p>Left Side Bar > Add object > Node. Refer to section 7.9.1.1 for more information.</p>	<p>Right click on a free area of the topology page and click on "Node" to add a new node. Refer to section 7.10.1 for more information.</p>
--	---

Step 2: The Add new node window will appear. You can scroll down to choose which node you wish to add to the lab topology, or you can type the node name to filter through the node list.







⚠ NOTE: It will only be possible to select and add nodes that have images preloaded in EVE. To prepare images for EVE, refer to section 18

Add Node

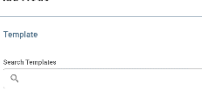
Step 3: Edit “Add a new node” settings. Please refer to the picture and table below.

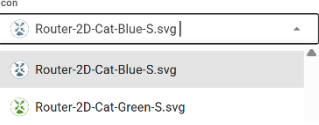
Add Node

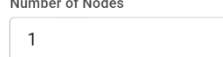
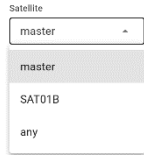
8.1.1.1 Node values Table

Number	Description
1.	<p>Add Node</p>  <p>Node Template menu. Choose which node template to add to the topology. After Template is selected, the Node configuration window will open. Selected template Edit options.</p>
2.	<p>Instance path. After the node will be created, the Instance path will appear, where the node is saved for your lab.</p>
3.	<p>Image</p>  <p>Choose your preferred version from preloaded images list (if you have more than one image loaded for a single template).</p>
4.	<p>Icon</p>  <p>Node icons can be changed from the default per your preference, simply choose the preferred icon from the dropdown list. Node icons can be changed later per your needs. Refer to section 7.9.2</p>
5.	<p>Name/prefix</p>  <p>Type your preferred node name. If you are adding more than one, EVE will automatically append numbers to the nodes name.</p> <p>Example. We are adding 5 CSR nodes with the name R. On the topology they will appear as R1, R2, R3, R4, R5. Later using the Nodes window, you can edit the node names per your needs. Refer to section 7.9.2 or edit the node individually, refer to section 8.1.2.</p>
6.	<p>Number of Nodes</p>  <p>Chose the number of nodes of this type you want to add to the topology</p>
7.	<p>Satellite</p>  <p>Node satellite selection. You can select desirable cluster satellite where this node will running. The default value is -1. This means EVE will automatically select first available cluster node (master server). Maser server will be selected if you have only single EVE server.</p>
8.	<p>Delay (s)</p>  <p>The Delay value is set in seconds and can be used to delay a node from booting after it is started. Example: if the value is set to 30, the node will wait 30 seconds before processing its boot sequense. This feature is useful in conjunction with the “Start all nodes” function</p>

	if your lab requires certain nodes to start up before others or to avoid a mass-start of very heavy nodes.
9.	<p>Startup configuration</p> <p>None <input type="text"/></p> <p>Startup configuration: Value can be changed to set your node to boot from saved configurations. Refer to section 10.3 for more details.</p>
10.	<p>QEMU Settings</p> <p>QEMU Version</p> <p>4.1.0 (tpl) <input type="text"/></p> <p>EVE will pre-set the best recommended QEMU version for each node template. This value can be changed per your needs.</p>
11.	<p>QEMU Arch</p> <p>x86_64 (tpl) <input type="text"/></p> <p>Qemu architecture is pre-set per image vendor recommendations. This value can be changed per your needs</p>
12.	<p>QEMU Nic</p> <p>vmxnet3 (tpl) <input type="text"/></p> <p>virtio-net-pci</p> <p>e1000</p> <p>i82559er</p> <p>rtl8139</p> <p>e1000-82545em</p> <p>vmxnet3 (tpl) <input type="text"/></p> <p>Type of Qemu NIC is pre-set per image vendor recommendations. This value can be changed per your needs.</p>
13.	<p>QEMU custom options</p> <p>-machine type=pc,accel=kvm -cpu host -serial mon:stdio -nographic -</p> <p>Qemu custom options are pre-set per image vendor recommendations. This value can be changed per your needs</p>
14.	<p>CPU</p> <p>1 <input type="text"/></p> <p>Each node template has a pre-set CPU value that aligns with vendor requirements. This value can be changed per your needs.</p>
15.	<p>RAM (MB)</p> <p>3072 <input type="text"/></p> <p>Each node template has a pre-set RAM value that aligns with vendor requirements. This value is displayed in MB and may be changed per your needs.</p>
16.	<p>CPU Limit <input type="checkbox"/></p> <p>CPU limit per node. This option is already set (checked/unchecked) per EVE recommendations. Refer to section 7.4.3</p>
17.	<p>Ethernets</p> <p>4 <input type="text"/></p> <p>The number of ethernet interfaces.</p>

	<p>⚠ NOTE for IOL nodes: Ethernet interfaces for IOL nodes are placed into groups of 4. A value of 1 for Ethernet means your node will have 4 interfaces.</p> <p>The serial interface option is available for IOL nodes only and follows the same grouping structure as ethernet interfaces. A value of 1 for Serial means your node will have 4 serial interfaces.</p> <p>Ethernet portgroups (4 int each) <input type="text" value="1"/> Serial portgroups (4 int each) <input type="text" value="1"/></p>
18.	<p>Console <input type="text" value="telnet"/></p> <p>Console types for each template are pre-set with recommended settings. The setting can be changes per your needs.</p> <p>NOTE: The Docker template contains a wide variety of images, therefore, please refer to section 14.2 for recommended console types for each docker image. Windows nodes can use either RDP or VNC but RDP needs to be enabled in Windows itself.</p>
19.	<p>UUID <input type="text"/></p> <p>The UUID number is assigned automatically after a node is created. You may also set it manually in case you are using a license that is tied to a particular UUID.</p>
20.	<p>First Eth MAC Address <input type="text"/></p> <p>Custom MAC address for Qemu nodes only. You can define your own MAC address for first interface. OPTIONAL:</p> <p>Templates for Cisco FirePower, F5, Linux, and Citrix have the option to manually set the MAC address for the first ethernet interface. This will enable the use of licenses that are tied to a particular MAC address.</p> <p>MAC Address format must be like: 00:50:0a:00:0b:00</p>

8.1.2 Edit node

EVE provides two ways to edit nodes after being added to the topology canvas.

- ⚠ NOTE:** To force and apply a new setting, node must be **wiped** each time if an image, parameters or start up configuration has been changed.

8.1.2.1 Edit nodes globally

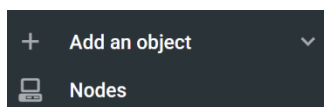

From the Topology page. Click “Nodes” from the left sidebar to bring up the nodes list. Refer to section 7.9.2 for more details.

8.1.2.2 Edit node individually.

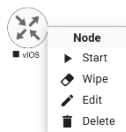

Right click on the node and click Edit

The “Edit node” window will appear. It is very similar to the window that is displayed when you add a new node. To change values for the node, refer to the nodes value table in section [8.1.1.1](#).

Edit Node

Template

vios

Main Settings

Instance Path
/opt/unetlab/tmp/10/ff3c01cb-c19a-4d31-845f-c3e4

Image
vios-adventerprisek9-m.SPA.159-3.M9

Icon
Router-2D-Gen-White-S.svg

Name/prefix
vios

Number of Nodes
1

Satellite
any

Delay (s)
0

Startup configuration
startup-001

X Position
1172

Y Position
186

Additional Settings

QEMU Settings

QEMU Version
2.4.0 (tpl)

QEMU Arch
x86_64 (tpl)

QEMU Nic
[empty]

QEMU custom options
-machine type=pc,accel=kvm -serial mon:stdio -nographic -no-user-config -nodefaults -rtc base=utc -cpu host

CPU
1

RAM
1024

CPU Limit

Ethernets
4

Console
telnet

Additional Options

UUID
4da2f47d-7f16-46fa-91a9-8d7e4db7f38f

First Eth MAC Address
50:0a:00:0d:00:00

SAVE CANCEL

8.1.3 Wipe Node

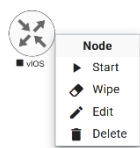

The “Wipe node” function will clear the NVRAM of the node. Each time a node setting is changed (CPU, RAM, boot image or startup configuration) a wipe must be issued on that node. For more information refer to section [10.3](#)

8.1.4 Interconnecting nodes

To connect nodes on the lab, use the drag and drop style method



Connector symbol: Moving the mouse over a node will make an yellow male plug appear. The male plug is used to connect nodes on the topology, drag and drop style. Release the mouse pointer on the second node.



The connection window will appear. Choose the interface you want to use to interconnect the nodes. Click Save when finished.

Create Link

vIOS

Linux

Source node (vIOS)

Choose Interface for Source
Gi0/0

Destination node (Linux)

Choose Interface for Destination
e0

SAVE
CANCEL

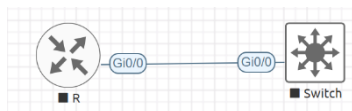

8.1.5 Edit connection link style

Right click on the connection link and choose Edit Style

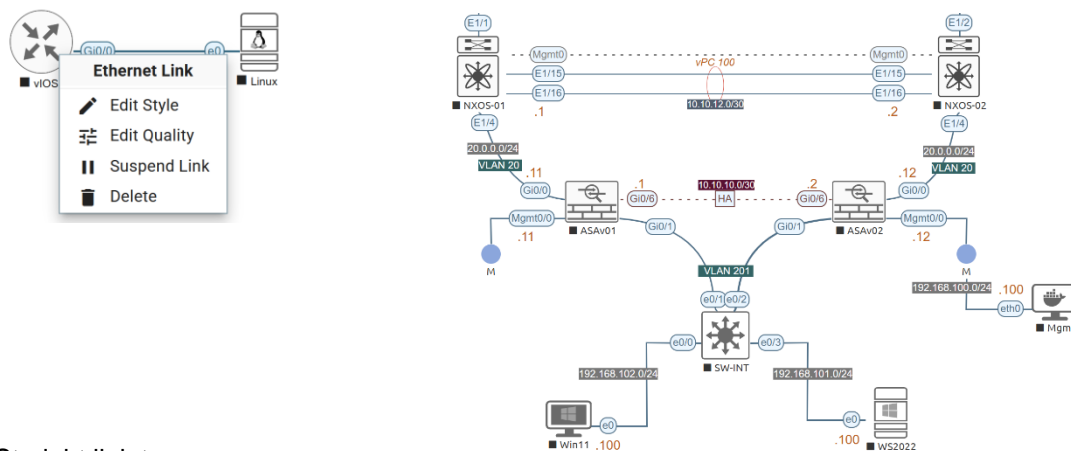

Straight link type

Style: vIOS - Gi0/0 -> Linux - e0

Link Type: Straight

Color: #3e7089

Link Style: Solid

Link Width: 2

Stub: [Slider]

Source Position: [Slider]

Destination Position: [Slider]

Link Label: [Input]

Label Position: [Slider]

SAVE
CANCEL

Bezier link type

Style: vIOS - Gi0/0 -> Linux - e0

Link Type: Bezier

Color: #3e7089

Link Style: Solid

Link Width: 2

Bezier Curviness: [Slider]

Source Position: [Slider]

Destination Position: [Slider]

Link Label: [Input]

Label Position: [Slider]

SAVE
CANCEL

Flowchart link type

Style: vIOS - Gi0/0 -> Linux - e0

Link Type: Flowchart

Color: #3e7089

Link Style: Solid

Link Width: 2

Round: 0

Midpoint: [Slider]

Source Position: [Slider]

Destination Position: [Slider]

Link Label: [Input]

Label Position: [Slider]

SAVE
CANCEL

Colour: Allows you to choose a colour for the link. This can be edited later in the “Shape Edit” menu.

Link Style: Allows you to choose solid or dashed style for link. This can be edited later in the “Shape Edit” menu.

Round: Link round angles, Flowchart link type only

Midpoint: Link mid point change, Flowchart style only

Source position “interface” label: Allows move and position source interface label

Destination position “interface” label: Allows move and position destination interface label

Link Style: Allows you to choose a style Straight, Bezier, Flowchart or StateMachine for the link. This can be edited later in the “Shape Edit” menu.

Link Width: Allows you to choose a thickness for the link. Default thickness of link is 2.

Link label: Allows you to add a label on the link. This can be edited later in the “Shape Edit” menu.

Label Position: Allows move and position Link label, position it on the link

Curviness: Link curviness feature for Bezier style link

Midpoint: Link mid point change, Flowchart style only

Stub: Stub link connection beside node, Straight style only

For edit Link style use mouse right click on link to call out link style editor.

8.1.6 Edit connection link quality

Right click on the connection link and choose Edit Quality. This function will allow apply on live connection Delay in ms, Jitter in ms, Packet loss in % and rate in kbs. If the Link quality is in use, then Orange indicators on the link will report where it is applied,

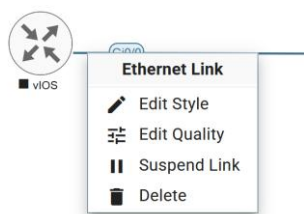

Link Quality: vIOS - Gi0/0 -> Linux - e0

It is recommended to apply value divided by 2 on both link interfaces to achieve precise connection quality. In the example below is applied 25% and 25% packet loss, which gives result of 50% packet loss in connection between nodes.

Source Interface: Gi0/0			
Delay (ms)	Jitter (ms)	Loss (%)	Rate (kbps)
0	0	0	0

Destination Interface: e0			
Delay (ms)	Jitter (ms)	Loss (%)	Rate (kbps)
0	0	0	0

APPLY SAVE CANCEL

8.1.7 Suspend or resume link connection

The EVE-Pro has integrated feature to detect connection state on the interface.

Additional Options

Enable L1 keepalive

For IOL nodes please select enable L1 Keepalive under Edit node to allow suspend feature.

Right click on the connection link and choose **Suspend Link**. This function will suspend connection between the two nodes. Literally, it will act like disconnected cable from the node, and interface will detect it as no connection. Suspended link will be marked with red dots. To resume link connection, right click on the link connection and choose **Resume Link**.

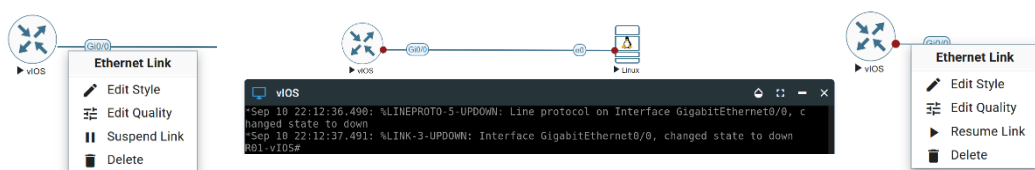

Supported nodes with suspend/resume feature:

Supported nodes for Link Suspend/resume	Not supported
IOL vIOS XRv9K CSR CSR SD-WAN ASA v Firepower FTD Juniper vSRX NG Juniper vMX VCP/VFP Juniper VRR Nokia Timos SR 19.5.1 Windows All Linux All Apple OSX Mikrotik Palo Alto F5 Fortigate Checkpoint Cumulus Cyberoam FW Sophos FW SonicWall FW Viptela Velocloud Versa Networks sd-wan pfSense Brocade vADX Barracuda NGFW HP VSR1000	Arista NXOS 9k ASA ported XRv Old Juniper vMX Juniper vQFX Dynamips

⚠ NOTE: Avoid use Link suspend feature if you have configured: IOL L3 router image with:
If the IOL L3 node interface is configured as DHCP client (ip dhcp), IOL node is attempting to bring up interface in up/up state. If you have enabled Link suspend feature on such configured interface, the node will flap link connection up/down/up.
Same behave is observed if your Serial interface is configured with PPP encapsulation.

Other observations:

vIOS L2 image has minor internal issue. LACP protocol does not detect interface state as down/down

8.1.8 Delete connection between nodes

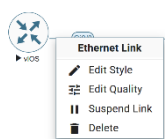

To delete a connection, right click on link/connection and hit "Delete."

8.1.9 Delete Node

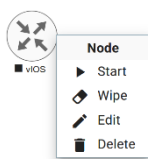

To delete a node, right click it and hit "Delete." This is a non-reversible function

NOTE: It is strongly recommended to delete connections from a node before deleting the node itself.

8.2 Running labs

8.2.1 Starting lab

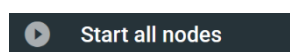

Nodes inside a lab may be started individually, in groups, or all at once.

The Start all nodes option will start all nodes on your topology.

⚠ IMPORTANT. Starting all the nodes at once can result in major spikes in CPU utilization. Please make sure you are not using the "Start all nodes" option for heavy labs. Instead, it is recommended to start nodes in small groups.

Starting a node or group of nodes:

Right click on single node or node group and hit "Start."

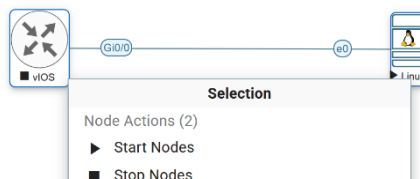
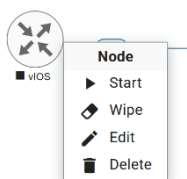

Running nodes will turn blue. Refer to section 7.11 for node states

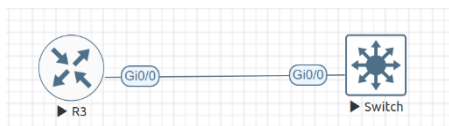

8.2.2 Interconnecting running nodes (hotlinks)

Eve Professional offers the hotlinks feature which allows you to interconnect node in the running state.

Connector symbol. Moving the mouse over a node will make a yellow male plug appear. The male plug is used to connect nodes on the topology, drag and drop style. Release the mouse pointer on the second node



Create Link

Source node (vIOS)
Choose Interface for Source
Gi0/0

Destination node (Linux)
Choose Interface for Destination
e0

SAVE

CANCEL

8.2.3 Link quality delay, packet loss, jitter and rate feature

Please refer to Section 8.1.6

8.3 Saving labs

To save a running lab, refer to the vendor recommended save commands for each node.

Example:

Cisco: "copy run start"

Juniper "commit"

Your current work will be saved in the nodes' NVRAM and the lab can be stopped safely. Starting the lab again will allow you to pick up from where you left off.

⚠ WARNING: Using the wipe action on a node will clear its NVRAM. This is similar to doing a factory reset on a device.

The configurations of nodes can be exported and used as initial or startup configurations for your labs. To export configurations and configuration sets for labs refer to section 10.1

8.4 Stopping labs



Stop all nodes

The Stop all nodes option will stop all nodes on your topology.

NOTE: It is recommended to save your running configurations before you stop your nodes.

Stopping a node or group of nodes:

Right click on single node or node group and hit "Stop."

For individual node Stop options refer to section [7.10.7](#)

8.5 Start saved lab

Click to the lab you want to start and click “Open”. To start Lab refer section [8.2.1](#)



8.6 Working with multiple running labs

Refer to section [7.2.1.1](#)

8.7 Importing labs

Refer to section [7.2.2.6](#)

8.8 Exporting labs

Refer to section [7.2.2.5](#)

8.9 Deleting labs

Refer to section [7.2.2.2](#)

8.10 Moving labs

Refer to section [7.2.2.4](#)

8.11 Shared Project/Lab

EVE-NG provide an option to share single running lab between users. It is designed to run single lab for many users who can participate in lab session and configure it.

Note: Lab sharing option can be used between any of EVE NG User roles.

- ✓ Administrator can share lab for other Administrators, Lab Editors or Lab Users.
- ✓ Lab Editor can share lab for Administrators, other Lab Editors or Lab Users

- ✓ Lab User can share lab for Administrators, Lab Editors or other Lab Users.

8.11.1 Create Project Lab share

Step 1. Navigate to EVE main Lab tree and select which lab you want to share with others. *Do not create shared Project lab from Shared folder to avoid lab names duplication.*

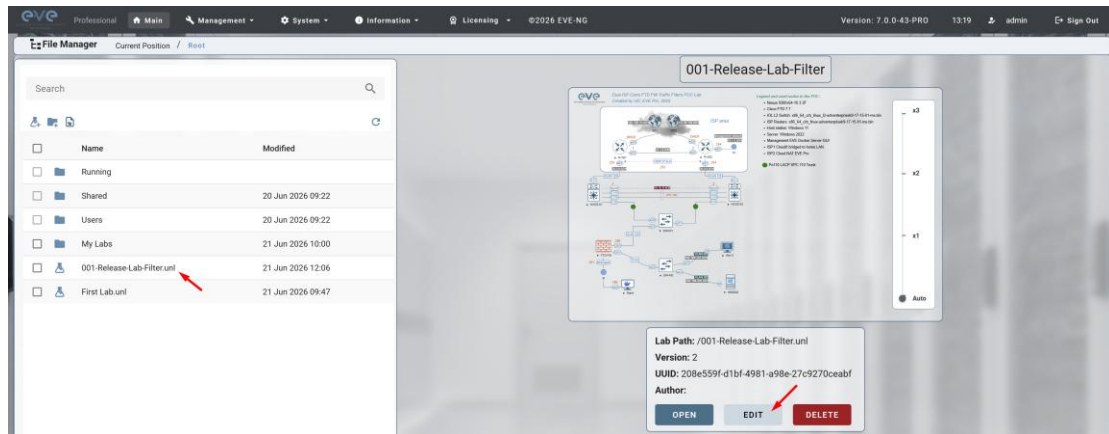

Step 2: From menu “Shared with” select Users to whom you want to share lab

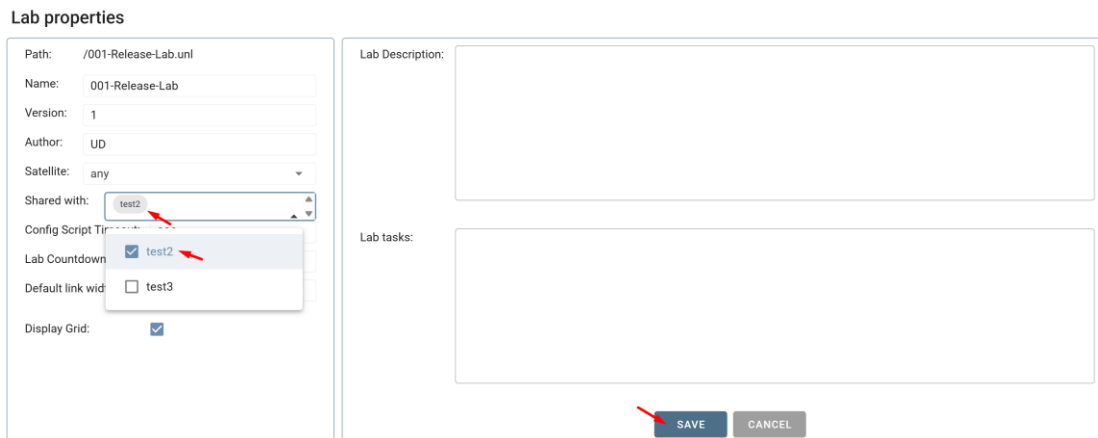

8.11.2 Remove Lab share

Note: Only owner of lab share can remove sharing.

Step 1. Navigate to EVE main Lab tree and select shared and click “Edit”

Step 2: Deselect to remove users from Shared with

Lab properties

Path: /001-Release-Lab.unl

Name: 001-Release-Lab

Version: 1

Author: UD

Satellite: any

Shared with:

Config Script Time:

Lab Countdown: test2 test3



Default link width: test3

Display Grid:

Lab Description:

Lab tasks:

SAVE CANCEL

- ❖ NOTE: Once Lab is shared with users, it will display Shared Lab symbol (green) beside of Lab name.  001-Release-Lab.unl 

8.11.3 Working with shared lab

Step 1: Owner of shared lab **starts** the lab. To join in the shared project lab, owner of lab must start it.

Step 2: Other user to whom this lab is shared, log into EVE with his account

Step 3: Open Shared Lab folder, the lab shared to him will appear as shared lab with owner user in brackets. (Example: admin user shared lab for test2 user)

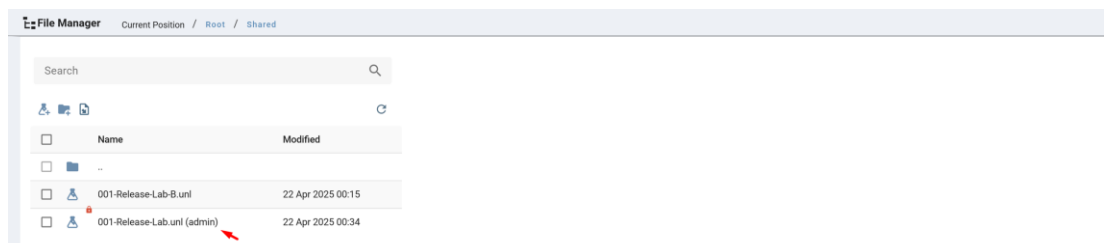

Accordingly, permissions of user roles:

- ✓ Administrator can start, stop or edit lab.
- ✓ Lab Editor can start, stop or edit lab.
- ✓ Lab user can start and stop lab

When you join in the shared lab, on the top of left side bar menu, you will notice the name of lab owner.

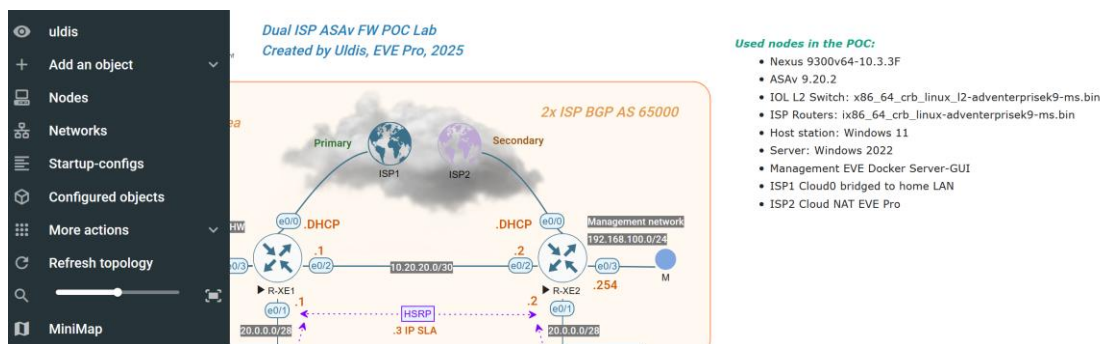

Note: If the Lab is been edited by Administrator, changed links connections or nodes, other shared lab users must refresh this lab topology to obtain changes.

Note: Parallel Consoles

Telnet Consoles: can be opened parallely for any user

VNC Console: can be opened parallely for any user

RDP Console: Only one user at same time can use RDP console to the node

8.12 Assigned single lab

Pre-requisites for this feature: For Lab selection from the list, the Lab must be upload in the **Shared folder** by admin first. If Lab Menu is selected to “None”, User can close the Lab and open another shared Lab for him.

Applies for Lab User role only. Set the specific Lab for the user “Assigned/sticky lab”. After login in the EVE User will directed only to this lab. He cannot close the lab to get in main management page. User can Start/Stop/Wipe lab, as well save his lab work on the lab devices. Follow Section: **7.3.1.5**



Edit User

<p>User Name* test3</p> <p>Password</p> <p>Confirm Password</p> <p>Authentication internal</p>	<p>Role Lab User</p> <p>StickyConsole any</p> <p>Lab /Shared/001-Release-Lab-B.unl</p> <p>Satellites any</p>
--	--

9 EVE Clouds and Networks

9.1 Bridge Network

The EVE Bridge interface acts like an unmanaged Switch. It supports passing along tagged dot1q packets.

Example: We have to connect many nodes in a flat (dot1q) network

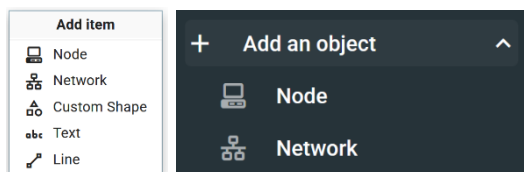

Step 1: Add a Bridge Network onto the topology. There are two ways to do this: Right-clicking on the topology area and selecting “Add Network” or in the sidebar click “Add an Object” and then select “Network.” Please refer to sections [7.10.5](#) and [7.9.1.2](#)

Step 2: Name/prefix can be changed in order to rename your Bridge network. Make sure your network type is set to bridge.

Add Network

The 'Network Settings' dialog box contains the following fields:

- Number of networks to add: 1
- Name/Prefix: Bridge
- Icon: Switch-2D-L2-Generic-S.svg
- Type: bridge
- Left: 1226
- Top: 393

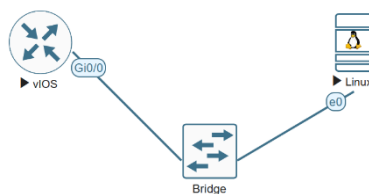

SAVE CANCEL

Step 3: Connect your nodes using the drag and drop connector. Refer to sections [8.1.4](#) and [7.10.5](#)

9.2 The Smart Bridge features

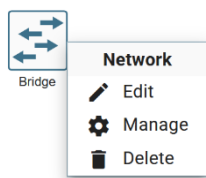

Smart bridge feature is available for EVE *Bridge and Internal Networks*. Using smart bridge feature, you are able to assign connected bridge ports with VLAN ID. Select “Manage”

Network Management

Network Settings

Network ID: Network Name:

Smart Bridge Enable 802.1ad

Connected Interfaces

NODE ID	NODE NAME	INTERFACE ID	INTERFACE NAME	VLAN ID
13	VIDS	0	Gi0/0	1
16	Linux	0	e0	1

VLAN ID 0 – untagged port, used for trunk assignment. User can define port vlan tags per lab needs. Example VLAN ID 10 is tagged port in VLAN 10.

Smart Bridge, enables 802.1q option.

Enable 802.1ad option allows to use bridge for QinQ mode.

9.3 Internal Network

Internal cloud network is used as an extended connector between nodes inside of one lab. It is isolated cloud which not visible for other labs or users.

EVE Pro is offering 3 independent Internal clouds/domains. It is isolated from each other. Inside of single lab you can have up to 3 isolated cloud/domain networks. Example of Internal cloud usage below:

Step 1: Add two internal cloud networks onto the topology.

Add Network

Network Settings

Number of networks to add:

Name/Prefix:

Icon:

Type:

Left: Top:

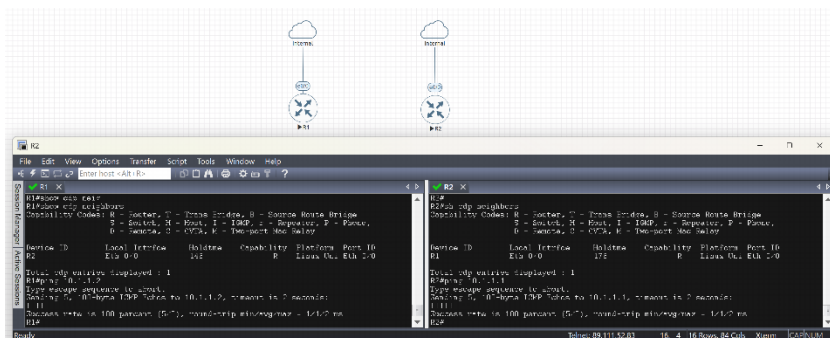

Step 2: Connect your lab nodes to internal cloud. Your configured nodes will work like being connected to the same switch (or the same bridge in EVE). CDP works. It is convenient if it is necessary to have connections across the lab and you don't want to have connections going from one end of the lab to the other.

9.4 Private Network

Add Network

Network Settings

Number of networks to add
1

Name/Prefix
Net

Icon
01-Cloud-Default.svg

Type
private

Left
1120

Top
507

SAVE CANCEL

Private cloud network is used as an extended connector between labs in the one user POD. Private cloud is isolated and not visible for other users.

EVE Pro is offering 3 independent Private clouds/domains. It is isolated from each other. Inside of single user POD you can have up to 3 isolated Private cloud/domain networks. Example of Private cloud usage below:

Example: Single user is running multi labs (Lab1 and Lab2), and want interconnect it.

Step 1: Add private cloud network onto the topology Lab1.

Step 2: Add private cloud network onto the topology Lab2.

Step 3: Connect your lab node to Private cloud. Your connected nodes in Lab1 and Lab2 will work like being connected to the same network. CDP works. It is convenient if it is necessary to have connections across the multi labs.

NOTE: Using Private cloud, avoid to connect nodes with same ID to it. It will raise MAC address collision in your connection. Pic below shows correctly interconnected Node ID1 in Lab1 and Node ID5 in Lab2.

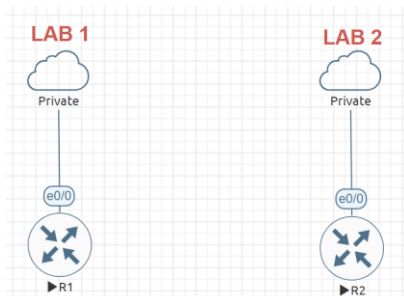

9.5 NAT Network

EVE-NG PRO has an embedded NAT interface with the subnet 172.29.129.0/24. This feature is similar to the VMWare NAT interface, but EVE is translating the 172.29.129.0/24 (this subnet is hardcoded in EVE and is not configurable) subnet to EVE's management interface pnet0. NAT network can be changed per your needs, please refer [7.4.1](#)

Add Network

To add a NAT Cloud onto the EVE topology:

Step 1: Add A New Network onto the topology. There are two ways to do this: Right-clicking on topology area and selecting “Network” or in the sidebar, “Add an Object” and then select “Network.”

Step 2: Name/prefix can be changed in order to rename your NAT network. Make sure your network type is set to NAT.

Step 3: Connect your nodes using the drag and drop connector. Refer to sections 8.1.4 and 7.10.5

If your EVE management is connected to the Internet, adding a NAT cloud onto the EVE lab enables you to have internet access from within your EVE lab using NAT.

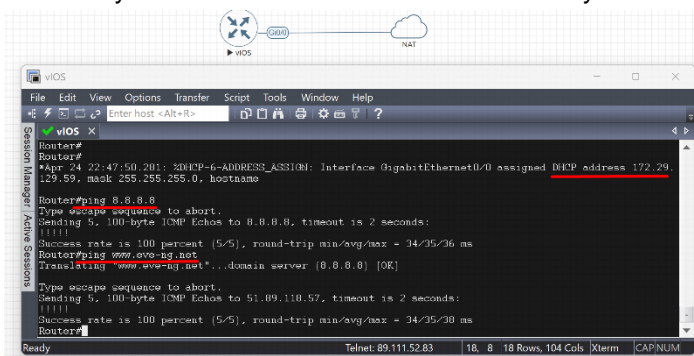

EVE NAT Gateway IP is:
172.29.129.254/24

DHCP is enabled on the EVE NAT Cloud.

9.6 Management Cloud0 interface

EVE management interface is also known as the Cloud0 network for labs. The Cloud0 interface is bridged with your EVEs first NIC. “Cloud” is used as an alias to pnet. Pnet is the bridge interface name inside of EVE.

```
# The primary network interface
iface eth0 inet manual
auto pnet0
iface pnet0 inet dhcp
bridge_ports eth0
bridge_stp off
```

Cloud0 is commonly used inside EVE labs to get management access to nodes running inside EVE from a host machine external to EVE.

⚠ IMPORTANT NOTE: For EVE VMs running on ESXi, with NIC Teaming Network, please follow the steps below to edit the reverse path settings

- ❖ From the Navigator window select **Manage > System > Advanced settings**.
- ❖ Scroll down or use the search bar to go to the **Net.ReversePathFwdCheckPromisc** option.
- ❖ Select **Net.ReversePathFwdCheckPromisc** and click Edit option.
- ❖ In the Edit option - **Net.ReversePathFwdCheckPromisc** window update the New value field to 1 and click Save.

⚠ IMPORTANT NOTE: For EVE VMs running on ESXi, make sure your management interface bridged with the vSwitch (Port group) has the security settings set to Accept. Any port group or vSwitch used to connect an external network to an EVE Cloud network needs to have the:

- ❖ Promiscuous mode: “Accept”
- ❖ MAC Address changes: “Accept”
- ❖ Forged transmits: “Accept”

vSwitch Settings

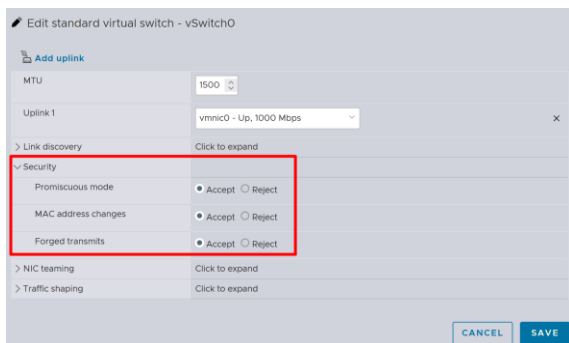

Portgroup Settings

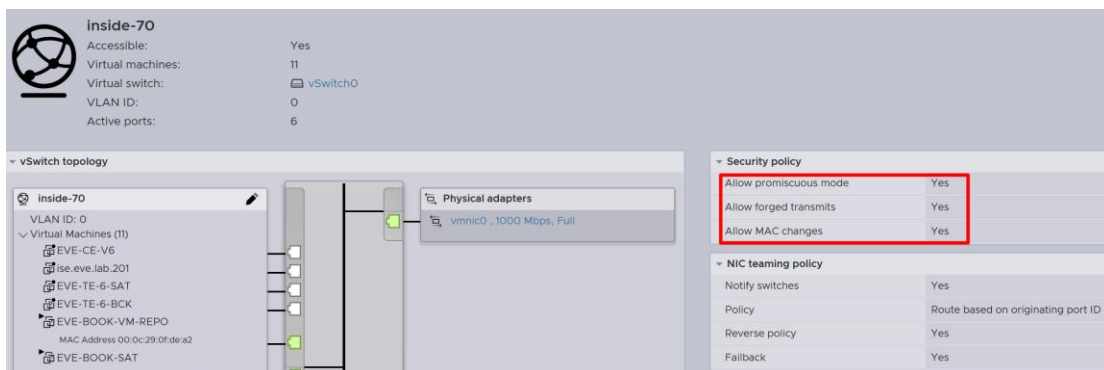

EVE Cloud0 bridging table.

Lab name	EVE interface name (inside)	Type	Notes
Cloud0	pnet0	Bridged	Cloud0/pnet0 is bridged with your primary EVE ethernet port. It is assigned a management IP address used for WEB GUI access. The EVE management subnet can be used as a management network in labs.

⚠ Question: How can I obtain my Cloud0 subnet and gateway IP. Many EVE VMs only have a DHCP address assigned on the pnet0 interface.

Answer: SSH to EVE and type the following from the CLI:

```
ip r
```

```
root@eve-ng:~# ip r
default via 192.168.70.254 dev pnet0
172.17.0.0/16 dev docker0 proto kernel scope link src 172.17.0.1 linkdown
172.29.129.0/24 dev nat0 proto kernel scope link src 172.29.129.254
172.29.130.0/24 dev wg0 proto kernel scope link src 172.29.130.254
192.168.70.0/24 dev pnet0 proto kernel scope link src 192.168.70.57
root@eve-ng:~#
```

Example: We want to use Cloud0 as a management network for an ASAv node in an EVE lab. From the above-obtained information, we know that our Cloud management subnet is 192.168.90.0 with a mask of 255.255.255.0 and the Gateway IP is 192.168.90.1.

Add Network

Step 1: Add A New Network onto the topology. There are two ways to do this: Right-clicking on topology area and selecting “Network” or in the sidebar, “Add an Object” and then select “Network.”

Step 2: Name/prefix can be changed in order to rename your Cloud0 network. Make sure your network type is set to Management(Cloud0).

Step 3: Connect your ASAv using the drag and drop connector to the Cloud0 network. Refer to sections 8.1.4 and 7.10.5

Step 4: Start the node and configure the interface connected to Cloud0 with an IP address from the management subnet (192.168.90.0/24 in this example). Make sure you do not assign duplicate IPs.

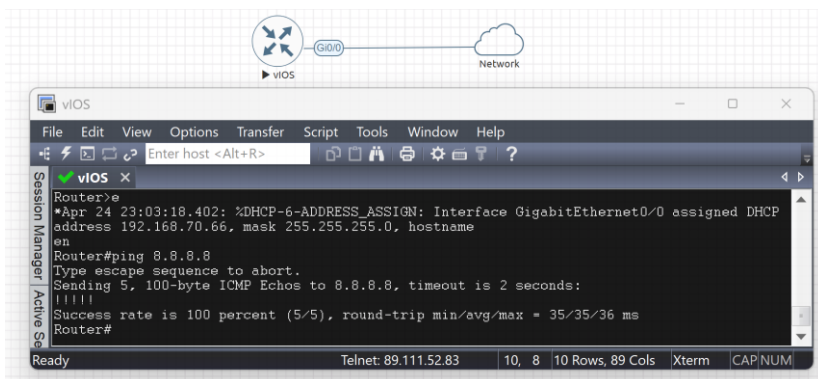

The native management host (home PC) can be used to manage nodes in the EVE lab over https. Example below showing http connection to Juniper vSRX FW node in the EVE lab from native PC using Firefox browser.

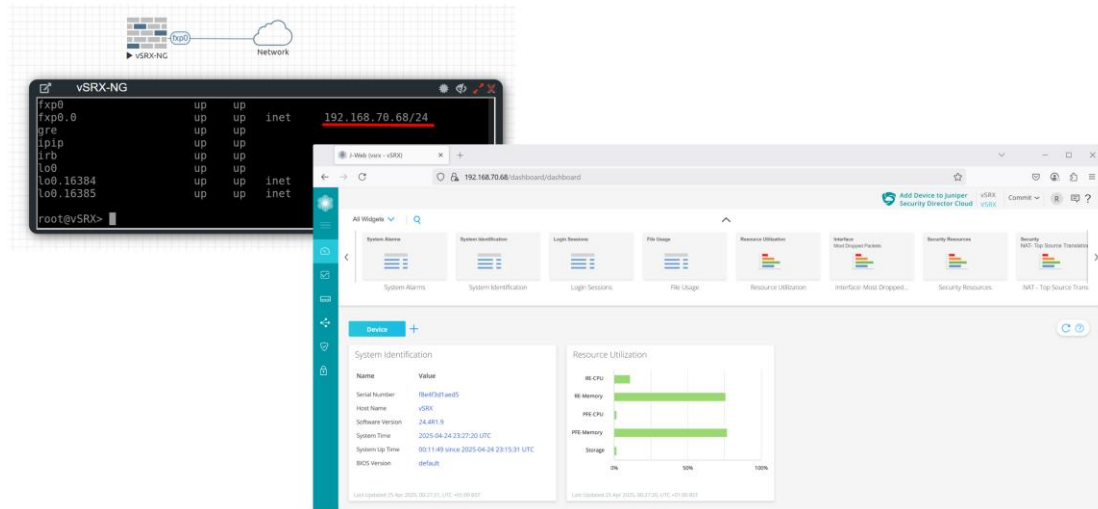

NOTE: Cloud interfaces can be used to connect multiple nodes to a single cloud instance on the topology.

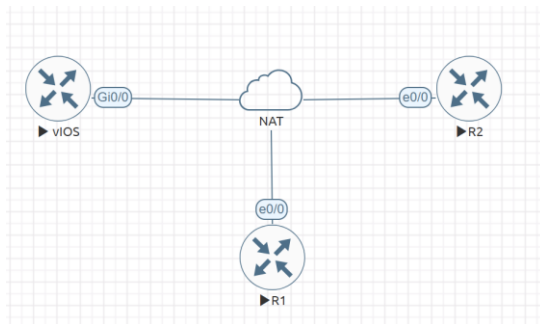

9.7 Remove cloud interfaces

For security reasons you can make cloud (Cloud0-9) interfaces invisible for the Lab Editors and Lab Users.

```
echo -n 1 > /opt/unetlab/natonly
```

To set back Clouds0-9 visible:

```
echo -n 0 > /opt/unetlab/natonly
```

All Clouds 0-9 will remain visible for Admin users.

9.8 Other cloud interfaces

Other cloud interfaces can be used to extend a lab connection inside of EVE or bridged with other EVE interfaces to connect external networks or devices.

EVE Cloud bridging table.

Lab cloud name	EVE interface name (inside)	Type	ESXi VM corresponding interface	VMware Workstation corresponding interface	Bare HW Server	Notes
Cloud0	Pnet0	bridged	Network adapter 1	Network Adapter	1st ethernet Eth0	Cloud0/pnet0 is bridged with your primary EVE ethernet port. It is assigned a management IP address used for WEB GUI access. The EVE management subnet can be used as management network in the labs.

Cloud1	Pnet1	bridged	Network adapter 2	Network Adapter 2	2nd ethernet Eth1	Cloud1 can be bridged with your EVE second ethernet port to achieve connection to another network or device. The IP address is not required to be configured on it. It will act like a pure bridge your external connection with EVE lab node.
Cloud2-9	Pnet2-9	bridged	Network adapter 3-10	Network Adapter 3-10	3rd-10th ethernet Eth2-8	Same as Cloud1

If some of the clouds (e.g. Cloud2) are bridged to another ethernet (VMnet) you can connect your EVE lab to an external VM or physical device (like e.g. a switch, IP phone or access point).

- ⚠ For ESXi make sure that you have set Promiscuous mode security settings on the vSwitch and Port group to Accept. Please refer to section 9.6

The next sections will explain how you can use Cloud networks in EVE to connect to other external (e.g. VMWare) VMs or physical devices.

9.9 Connecting external VM machines to the EVE Lab

9.9.1 ESXi VM machines

External ESXi VM machines can be connected to EVE labs using cloud interfaces.

- ⚠ **NOTE:** A single Cloud interface can be used to connect more than one external VM to the EVE lab.
- ⚠ **NOTE:** VM machines must be in a powered off state to assign network interfaces.

Example: Cisco ISE and Windows Server 2022 VMs connection to the lab using the Cloud2 interface.

Step 1: Create a new or use an existing vSwitch on your ESXi and as shown below. Make sure you have set all security policy mode on the vSwitch to Accept. Assignment to Physical adapters is not required for it.

Parent vSwitch “ESXi-Internal” settings:

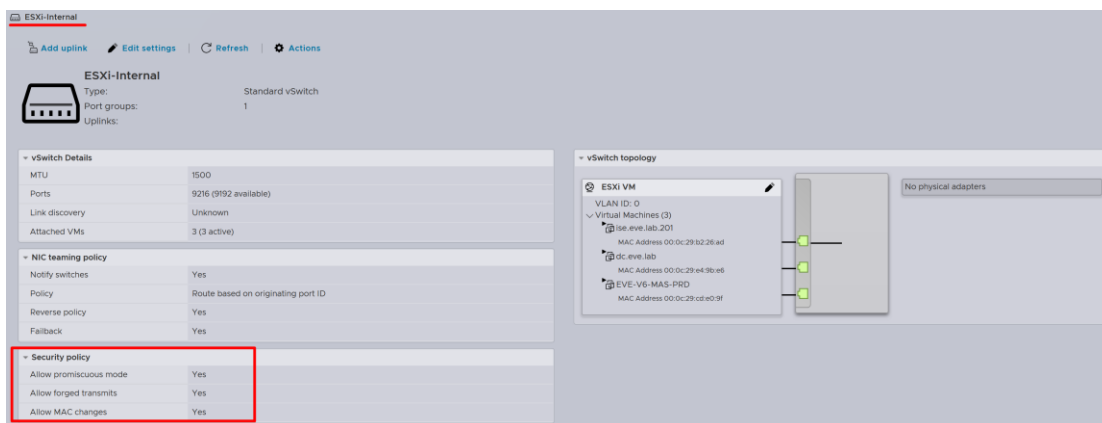

Port group “ESXi VM” (assign vSwitch “ESXi-Internal” as parent) settings:

Step 2: Create a new or use an existing Port group on your ESXi and assign it to vSwitch “ESXi-Internal” as shown below. Make sure you have set All security policy mode on the vSwitch to Accept.

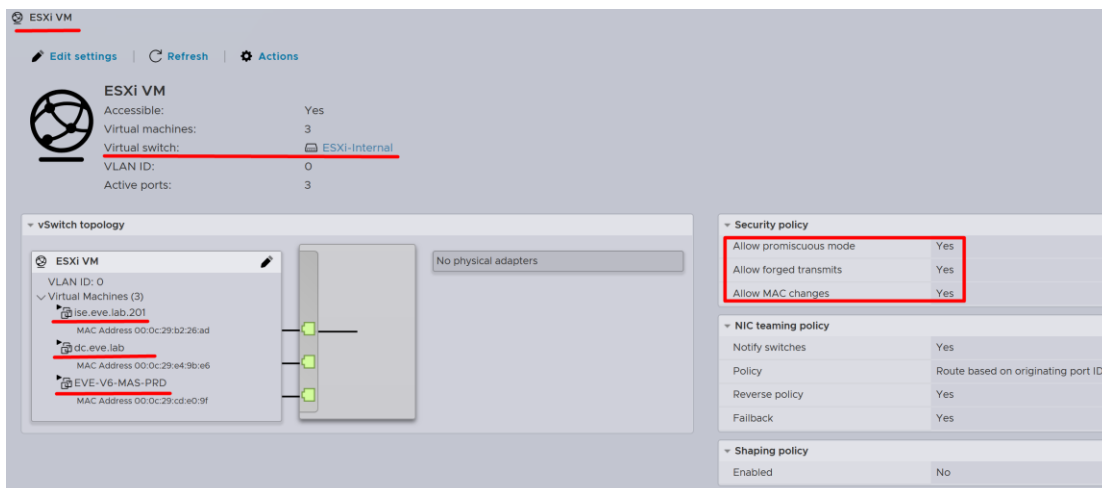

EVE VM and ISE VMs settings

EVE VM, 3rd NIC (pnet2/Cloud2) port is assigned to portgroup ESXi VM. It is Cloud2 on the EVE topology.

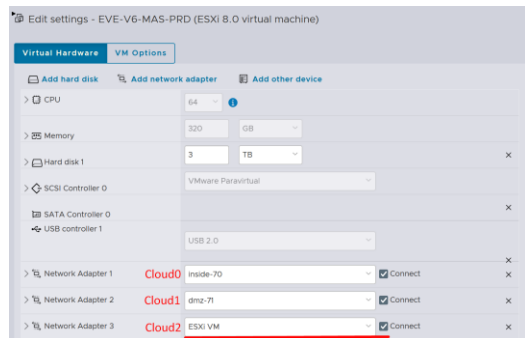

Cisco ISE VM, Management port is assigned in portgroup ESXi VM.

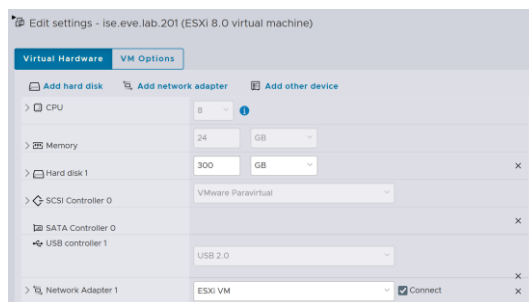

EVE Lab connected to the ISE (Cloud2)

- ⚠ **NOTE:** ESXi ISE VM has configured the IP 192.168.77.201 from the network on the lab switch. The gateway is 192.168.77.254
- ⚠ **NOTE:** The Docker node has configured the IP 192.168.77.200 from the from the network on the lab switch.

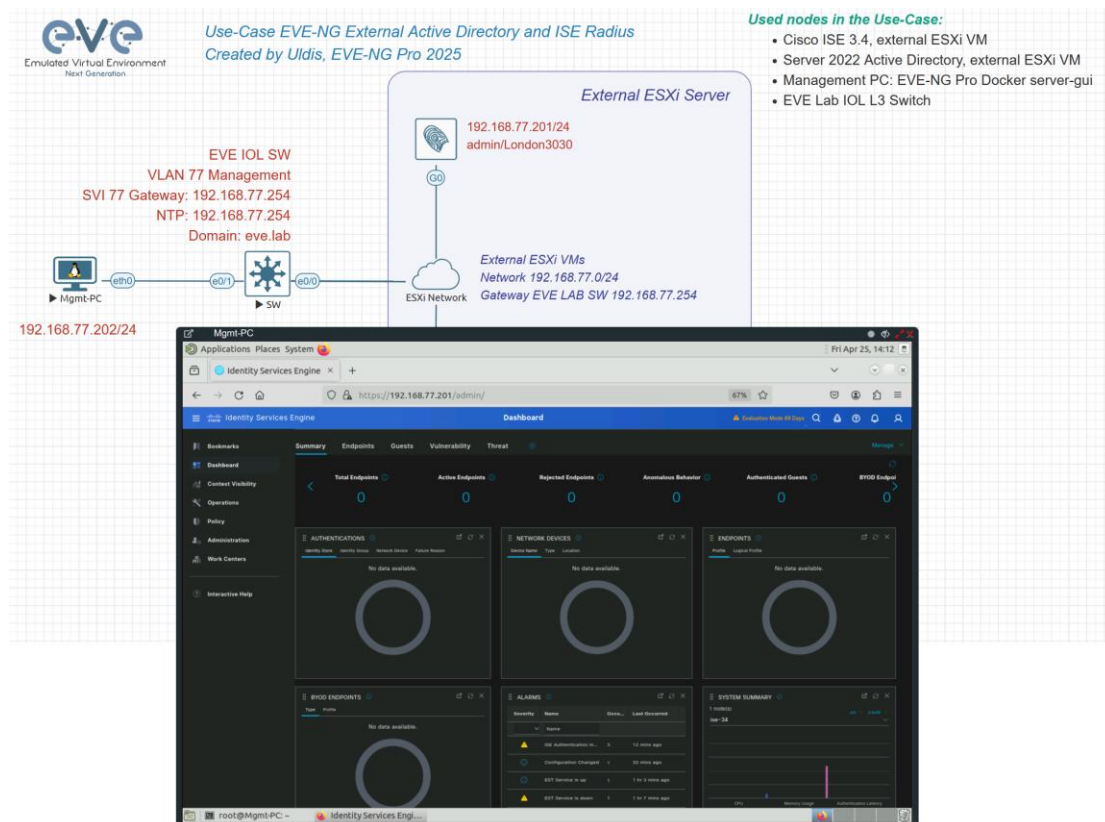

9.9.2 VMWare workstation machines

External (meaning not running inside EVE) VMWare workstation machines can be connected to EVE labs using cloud interfaces.

- ⚠ **NOTE:** A single Cloud interface can be used to connect more than one external VM to the EVE lab.

Example: Connecting Cisco ISE to the lab using **Cloud2** interface.

- ⚠ **NOTE:** VM must be in a powered off state to assign network interfaces.

Step 1: Open your VMWare Workstation Virtual Network Editor and configure the VMnet interface for the Cloud and WSA VMs. If necessary, add a new VMnet. The example below is showing VMnet2 Settings in VMWare workstation. DHCP must be disabled for VMnet2.

Virtual Network Editor settings:

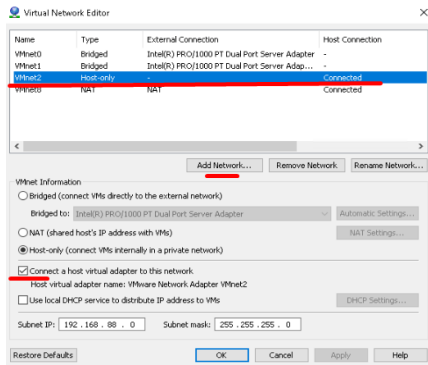

EVE and ISE VMs settings

EVE VM, the third port (Network adapter 3) is assigned to VMnet2. This is Cloud2 inside your EVE labs.

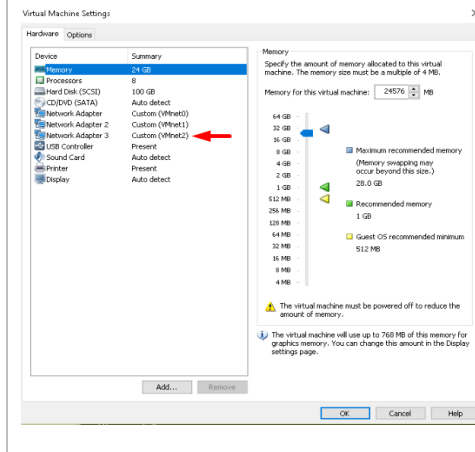

Cisco ISE, Management port is assigned to VMnet2

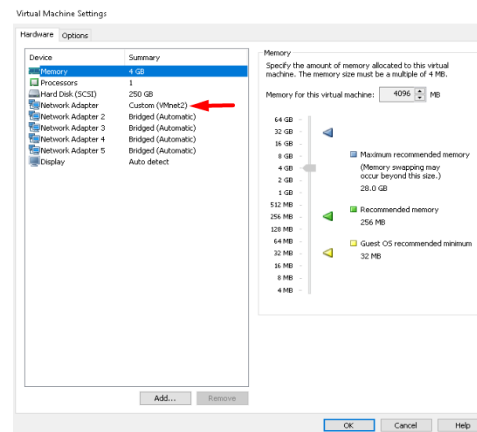

EVE Lab connected to the ISE (Cloud2)

- ⚠ NOTE: VM Workstation ISE VM management is assigned with IP 192.168.77.201 The gateway is 192.168.77.254
- ⚠ NOTE: The Server-GUI Docker node has assigned the IP 192.168.77.202 from the Lab switch network.

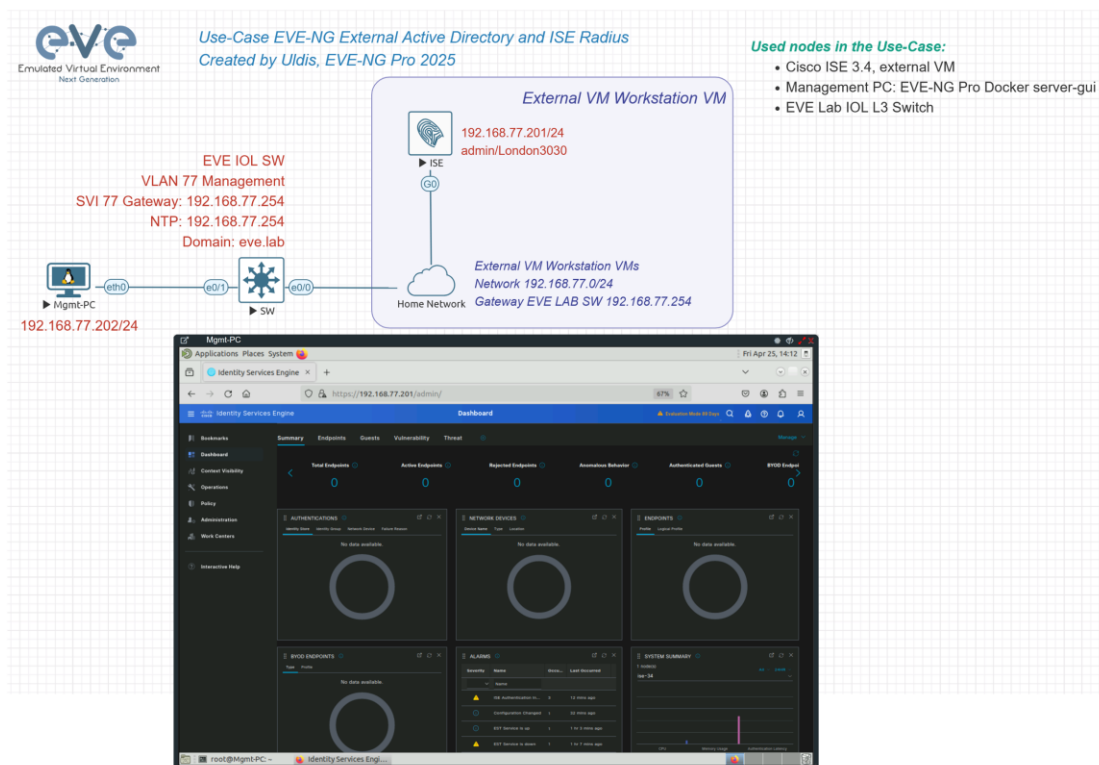

9.10 Connecting EVE Lab to a physical device

9.10.1 ESXi EVE

To connect a physical device (e.g. router, switch) to an EVE lab over a cloud interface, we have to bridge the ESXi NICs ethernet port to a VMnet interface.

- ⚠ **IMPORTANT NOTE:** Make sure that you have set Security Policy (Promiscuous mode, forged transmits and MAC changes) settings on the vSwitch and Port group to Accept.
- ⚠ **IMPORTANT NOTE:** If you are building trunk between EVE lab node to real Switch, please make sure you have set your ESXi vSwitch interface to accept all vlans. Reference: <https://kb.vmware.com/s/article/1004074>
- ⚠ **IMPORTANT NOTE:** For EVE VMs running on ESXi, with NIC Teaming Network, please follow the steps below to edit the reverse path settings
 - ❖ From the Navigator window select **Manage > System > Advanced settings**.
 - ❖ Scroll down or use the search bar to go to the **Net.ReversePathFwdCheckPromisc** option.
 - ❖ Select **Net.ReversePathFwdCheckPromisc** and click Edit option.
 - ❖ In the Edit option - **Net.ReversePathFwdCheckPromisc** window update the New value field to 1 and click Save.

The Example below is showing ESXi Server settings of the virtual network bridged to the physical interface.

Logical chain of the networking bridge:

EVE Lab Cloud1 → Port group “dmz-72” → vSwitch 1 → Physical Adapter vmnic1

vSwitch1 settings bridged with Server Ethernet port vmnic1 (physical adapter)

The screenshot shows the configuration for vSwitch1. The 'Security policy' section is highlighted with a red box, indicating the following settings:

Allow promiscuous mode	Yes
Allow forged transmits	Yes
Allow MAC changes	Yes

Port group “dmz-71” Settings associated with vSwitch1

The screenshot shows the configuration for the dmz-71 port group. The 'Security policy' section is highlighted with a red box, indicating the following settings:

Allow promiscuous mode	Yes
Allow forged transmits	Yes
Allow MAC changes	Yes

EVE VM Settings

EVE VM Cloud1/Cloud2/Pnet2 is connected to Port group “dmz-71”

Hardware Configuration	
CPU	64 vCPUs
Memory	320 GB
Hard disk 1	3 TB
USB controller	USB 2.0
Network adapter 1	inside-70 (Connected)
Network adapter 2	<u>dmz-71 (Connected)</u>
Network adapter 3	ESXi VM (Connected)

EVE Lab Connected to a physical device

Physical Topology

Cisco 887M device port Fastethernet 3 is physically connected to Server port eth1.

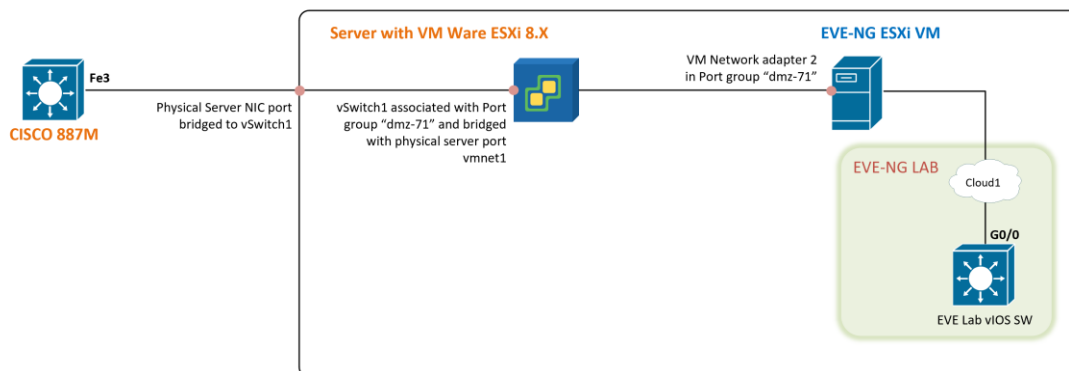

EVE Lab Topology

EVE lab switch port G0/0 is configured as trunk and connected to Cloud1 over bridged chain to the physical Cisco 887M Router switchport Fastethernet 3

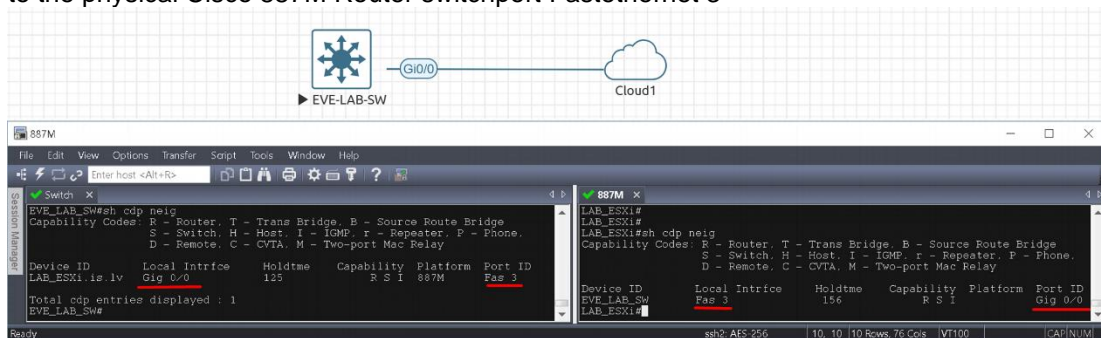

9.10.2 VMWare workstation EVE

Similar to the ESXi connection, it is recommended to have a second ethernet interface on your PC. It can be a USB ethernet extender as well. Not all ethernet adapters fully support a layer2 connectivity over it. MS Windows OS itself strips off any tags added to the packet. Even if your NIC supports 802.1q VLAN tagging, Windows 10 strips these tags off. The example below will show a Windows 10 host connected to a physical 3750G-24 switch. The Windows 10 Host has an Intel (R) PRO/1000 PT Dual port server adapter and is bridged with VMWare workstation (version 14) VMnets.

Virtual Network Editor Settings, Bridged VMnet interfaces with Real NIC Ports

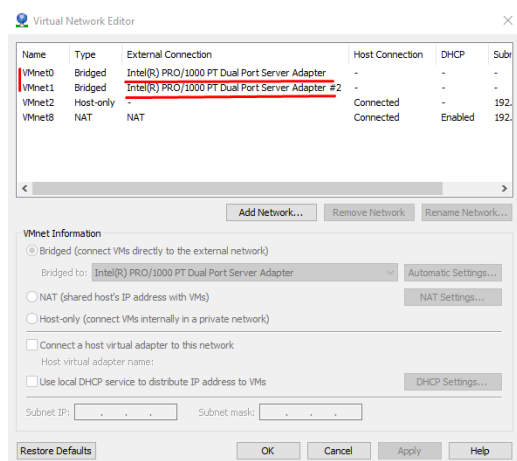

The following solution allows Windows hosts to transmit tagged packets over ethernet. This has been used in the example above.

- ⚠ Warning. You are making changes to your Windows registry files! This is at your own risk.

<https://www.intel.co.uk/content/www/uk/en/support/articles/000005498/network-and-i-o/ethernet-products.html>

9.10.3 Bare metal server EVE

A physical server usually has more than one ethernet port, free ports can be bridged with EVE clouds and used for external connections. EVEs internal interface settings are already bridged in order, pnet0-9 are mapped to eth0-9. Refer to the bridging table in section 9.7

```
cat /etc/network/interfaces
```

```
# Cloud devices
iface eth1 inet manual
auto pnet1
iface pnet1 inet manual
bridge_ports eth1
bridge_stp off

iface eth2 inet manual
auto pnet2
iface pnet2 inet manual
bridge_ports eth2
bridge_stp off
```

Basically, your servers physical port eth0 is bridged to pnet0 which is Cloud0 in your labs, eth1 is bridged to pnet1 which is Cloud1 in your labs (and so on). Refer to the bridging table in section 9.7

It is strongly advised on bare metal to always use the `nicorder-wizard` tool, even when NOT changing the NIC order, to ensure the order is fixed. Please refer section 16.2

The example below shows how to connect a bare-metal EVE server with a physical Cisco 3750E switch.

Physical connection topology:

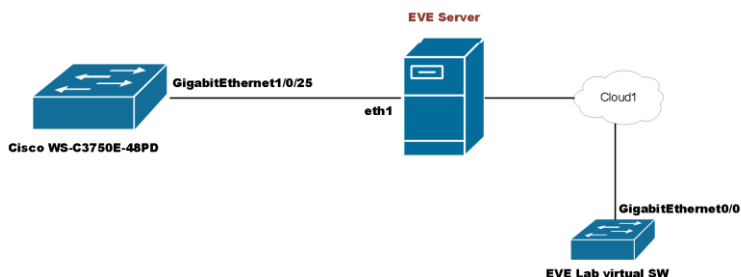

The EVE lab switch's CDP neighbour is the 3750E switch's port Gig 1/0/25: A trunk has been configured between the EVE lab switch and the physical 3750E switch.

```
Switch#sh cdp neig
Switch#sh cdp neig
Capability Codes: R - Router, T - Trans Bridge, B - Source Route Bridge
                  S - Switch, H - Host, I - IGMP, r - Repeater, P - Phone,
                  D - Remote, C - CVTA, M - Two-port Mac Relay

Device ID      Local Intrfce   Holdtme    Capability Platform  Port ID
NottsCoreRackSwitch1_DataServices.local
Gig 0/0       140            R S I WS-C3750E Gig 1/0/25

Total cdp entries displayed : 1
Switch#
```

10 Advanced EVE Lab features

10.1 Lab design objects

EVE Pro has drawing elements integrates to add drawings and text information to the lab topology. Objects can be placed on the topology in two ways.

Example below, EVE lab with design elements:

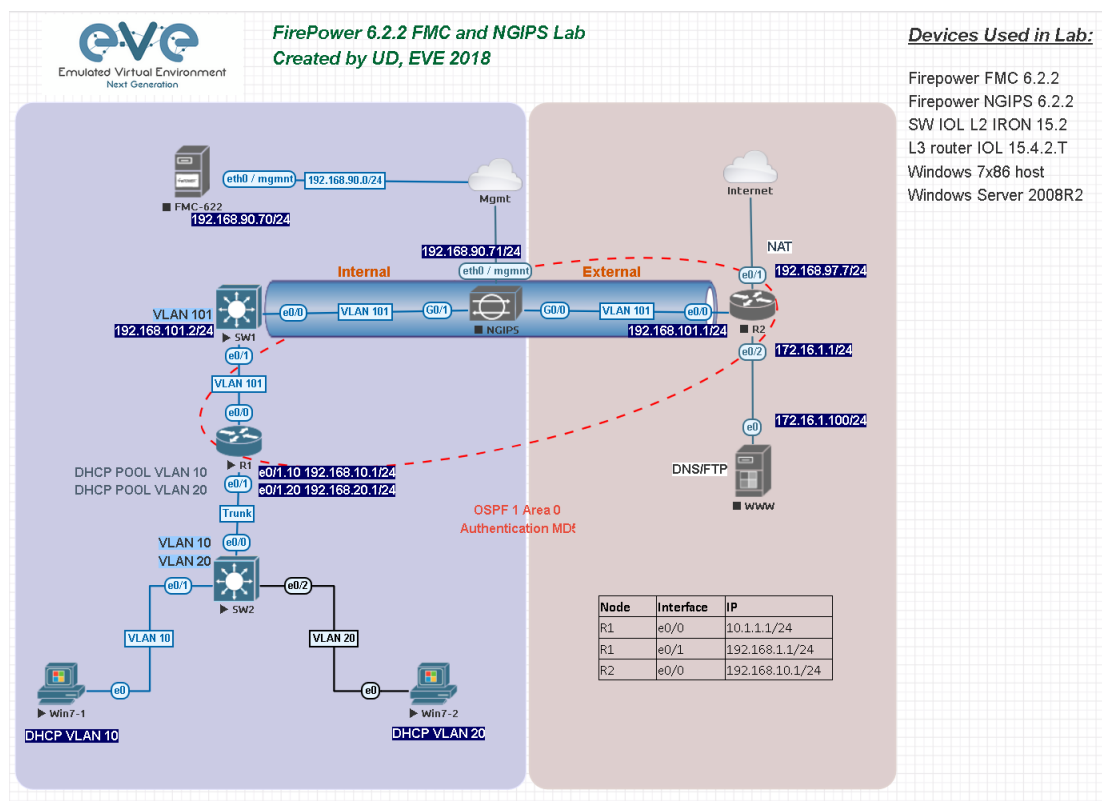

Option 1: Side bar -> Add an object

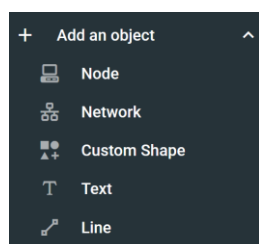

Option 2: Right-click on a free area on the topology canvas to add an object.

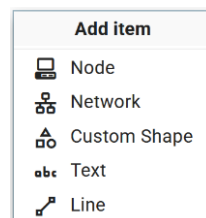

10.1.1 Custom shape

There are three custom shapes that can be added to the topology: square, round square and circle (sphere).

Shape Selection: Square, round square or circle

Custom Shape

Shape Selection

Shape Settings

Name

Border Type: solid | Border Width:

Border Color: #000000FF | Background Color: #FFFFFF

ADD SHAPE
CANCEL

Name: This field can be filled with your preferred shape's name. If the field is left empty, EVE will generate a name for the shape.

Custom Shape: Rectangle, Rounded rectangle, Circle

Border type: Two options: solid or dashed line

Border width: Increase or decrease the width of the border. This can be edited later in the "Shape Edit" menu.

Border colour: Allows you to choose a colour for the shape's border. This can be edited later in the "Shape Edit" menu.

Background colour: Allows you to choose a colour to fill your shape with. This can be edited later in the "Shape Edit" menu.

Example: Added a circle and square on the topology. Shapes can be moved around the topology drag and drop style (click and move with mouse).

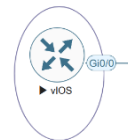

10.1.2 Resize square or circle objects

Move your mouse over the right bottom corner of the object until a corner symbol appears. Left click and drag your mouse to change object size or style (rectangle, sphere)



10.1.3 Text objects

Add item

- Node
- Network
- Custom Shape
- Text
- Line

It is also possible to add text or other MS Office objects to your EVE topology. Rich HTML Office option allows you to copy texts from MS Word, Excel or Visio.

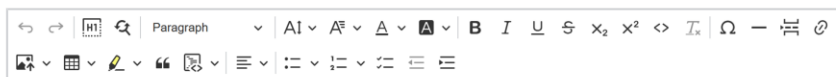

New Text

Your text. It can be copied from MS, also Visio. Similar like MS Office content. You can edit text here.

Example: Copied Excel table on topology in text:

A	B	C
1	2	3
11	12	13

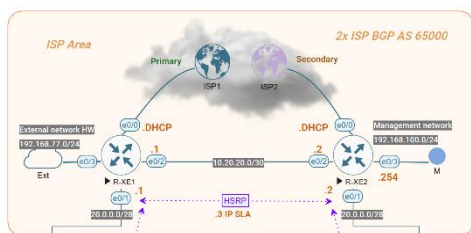

Example: text objects added to the topology.

Example: Visio object added to the topology

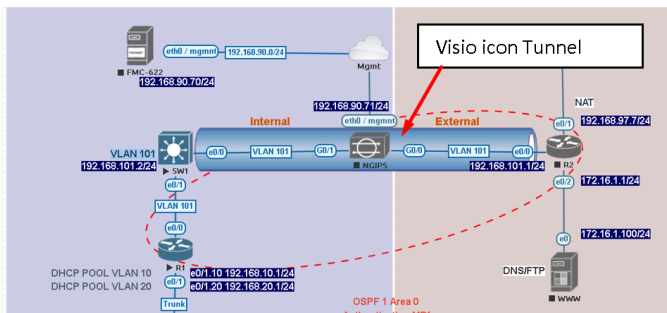

10.1.4 Add picture to the topology

Custom images may be added by using HTML editor:

Step 1: Add a text object to the topology and press Image button for import.

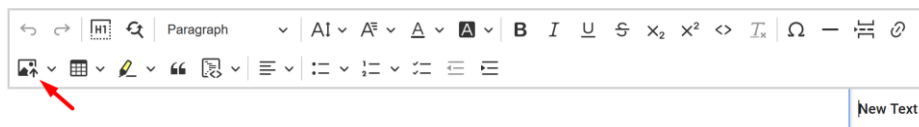

Step 2: User browse to import your image.

Step 3: Double click on object you wish to resize, then use frame corners to resize.

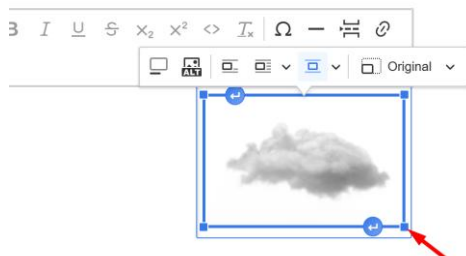

10.1.5 Custom object linking with telnet or other protocol

This feature allows you to link your eve topology object with external source. It can be web site or other protocol like Telnet to call out console for external object.

Step 1. Add the text or picture using HTML editor. Sections [10.1.3](#) or [10.1.4](#).

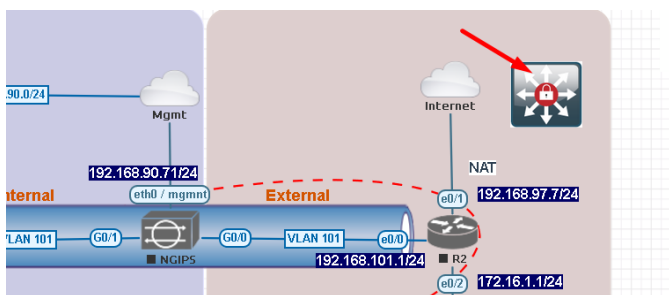

Example: Custom icon added from MS Visio.

Step 2. Position your object in place where you want it to be.

Step 3. Double click to highlight text or activate object and click on Link button

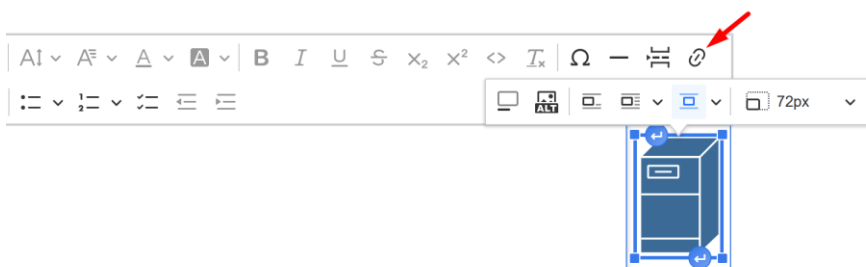

Step 4. Use link button to assign custom protocol for your object. Example: Protocol Other, type in URL: **telnet://192.168.10.100**

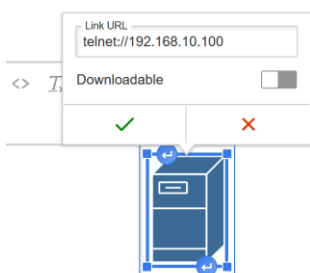

Step 4. Tab Target, Example: Target/New Window

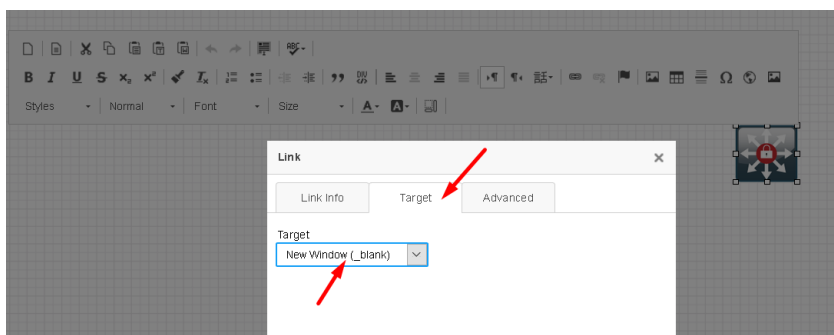

Step 5. OK for Save.

NOTE to edit picture object assigned with link, use mouse mark area of object and it and double click on area beside object.



10.1.6 Line object

Line object allows you to draw and design lines on the topology.

Step 1. Add a Line object to the topology

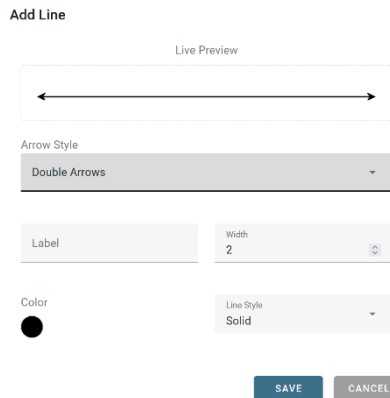

Arrow Style: Allows you to make arrows to your Line object. Single arrow, Double arrows or no Plain. This can be edited later in the “Shape Edit” menu.

Label: Add line object label. This can be edited later in the “Shape Edit” menu.

Width: Increase or decrease the width of the line. This can be edited later in the “Shape Edit” menu.

Paint Style: Allows you to solid or dashed style for line. This can be edited later in the “Shape Edit” menu.

Line Style: Allows you to choose a style Straight, Bezier, Flowchart or StateMachine for the line. This can be edited later in the “Shape Edit” menu.

Line colour: Allows you to choose a colour for the line. This can be edited later in the “Shape Edit” menu.

Example, Dashed, Bezier, double arrow line with label:

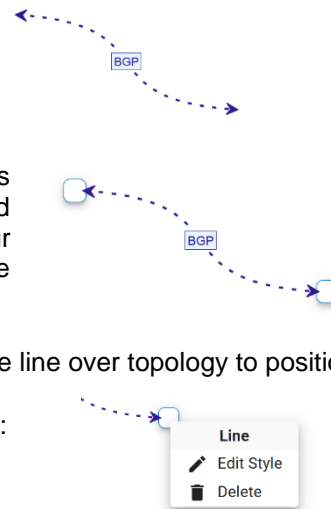

Positioning and moving line object. Line object has invisible connection points at the ends. Use mouse to find that point, drag and drop move line connection point to your preferred lab location. Use mouse to move other line endpoint on lab location.

To move all line, use CTRL to mark line endpoint and move line over topology to position it.

Edit Line object. Right click on line to call out edit window:



10.1.7 Nodes connection links design

Refer Section [8.1.5](#)

10.1.8 Cloning objects and overlay positions

Right click on the object you want to clone and choose “Duplicate”. You can also change the object’s overlay position using the “Send to Back” or “Send to front” options.

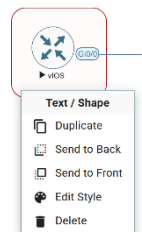

10.1.9 Objects Editing Style

Right click the object and choose “Edit Style” for additional options.

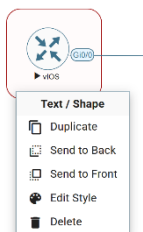

At the bottom of the “Topology Canvas” page, additional object options will appear



Z-index: Used to change the object’s overlay position on the “Topology Canvas.” An object with a higher numerically valued z-index will cover an object with a lower numerically valued z-indexed.

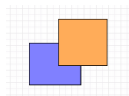

Example: The blue object has a z-index of -1 and the orange object’s z-index is 0. Orange object is top over blue object.

Border width: Used to change the object’s border width.

Border type: Used to change the border style of the object between solid and dashed.

Border colour: Used to change the colour of the object’s border

Background colour: Used to change the background colour of the object

Transparent: Turns off background colour (filling) and makes the object transparent.

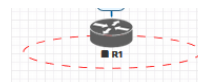

Rotate: Used to rotate the object on the topology.

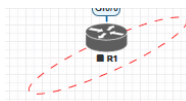

Name: Used to change the object’s name.

To save the object, press Save (Blue button).

10.1.10 Lock objects movement

The “Lock Lab” feature prevents objects from being moved around on the canvas (among other things). For more information about this feature, refer to section [7.9.16](#).

10.2 Custom design logical topology

EVE Pro includes a feature to upload your own custom topology picture and map nodes to it for easy access.

10.2.1 Custom design upload

Before you upload a custom picture in the lab, make sure it is in .png or jpg format with resolution 130-150x130-150 pixels.

TIP: It is best is to create a topology in the MS Visio and after convert it to the .png picture format with resolution 140x140.

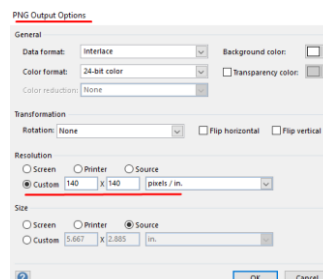

Step 1: Open “Logical Topology” from the left side bar and then “Pictures” from the left sidebar and hit + “Add Logical Topology.”

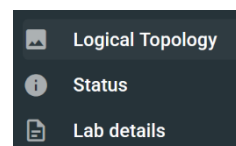
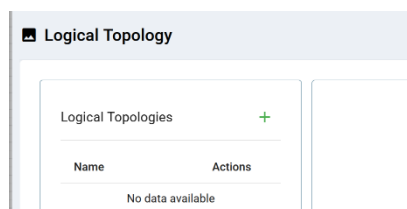

Step 2: Give the name for your logical topology and Browse your PC for a .png or .jpg file and hit “Add”.

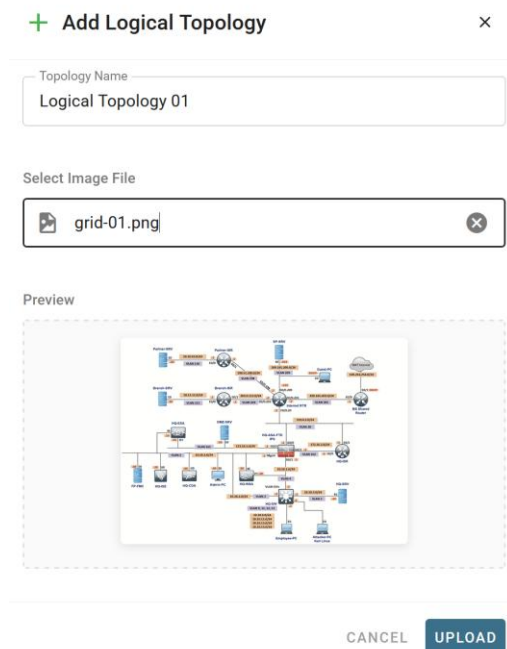



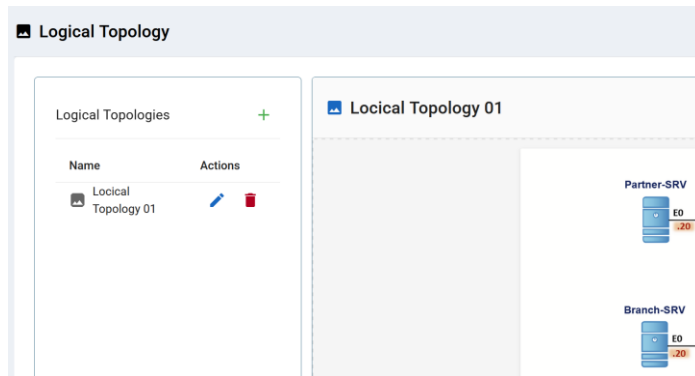



Once the picture is added to the Logical topology, the sidebar will display a new Actions: Edit or Delete



Step 3: Select Edit the “Logical Topology”.

Logical Topology window management

	Delete uploaded topology picture from the lab
	Edit/Image Map: Map nodes to places in the topology
	Display uploaded topology. Work with lab and custom topology
	Zoom/unzoom uploaded custom topology
	Hide/Unhide the Left side topologies toolbar
	Autofit on the screen.
	Close “Topology” window.

10.2.2 Custom topology mapping

This feature allows you to map the lab nodes to your custom topology picture.

Step 1: Click Edit Logical topology which you want make active:

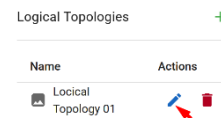

Step 2: Select a node, from the dropdown menu, that you want to map to the topology.

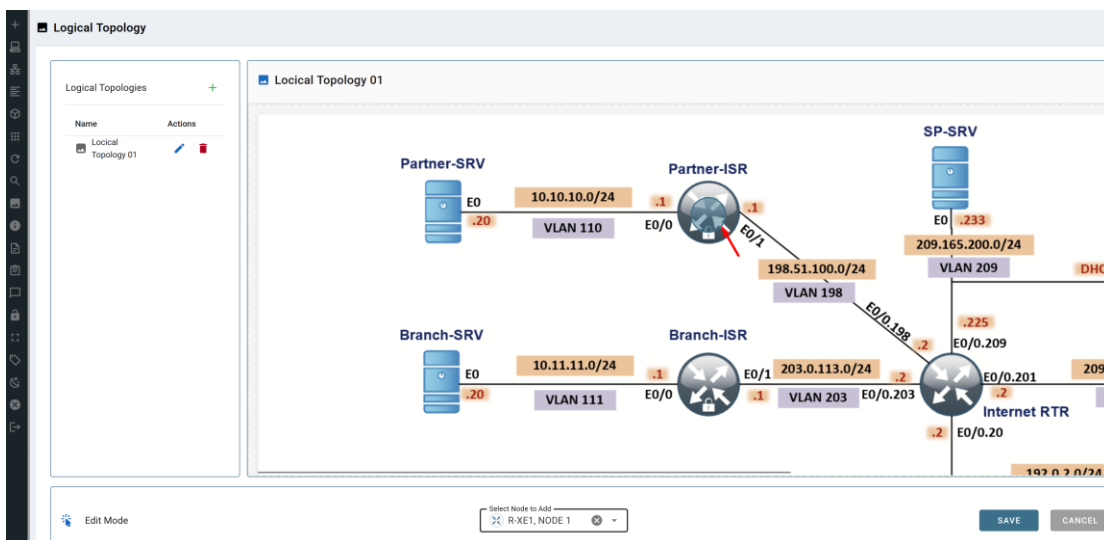

Step 3: Move your mouse over a node icon on the “Logical topology” and click to map it. The blue/grey circle means that the node is mapped.

Step 4: Continue mapping the rest of the nodes.

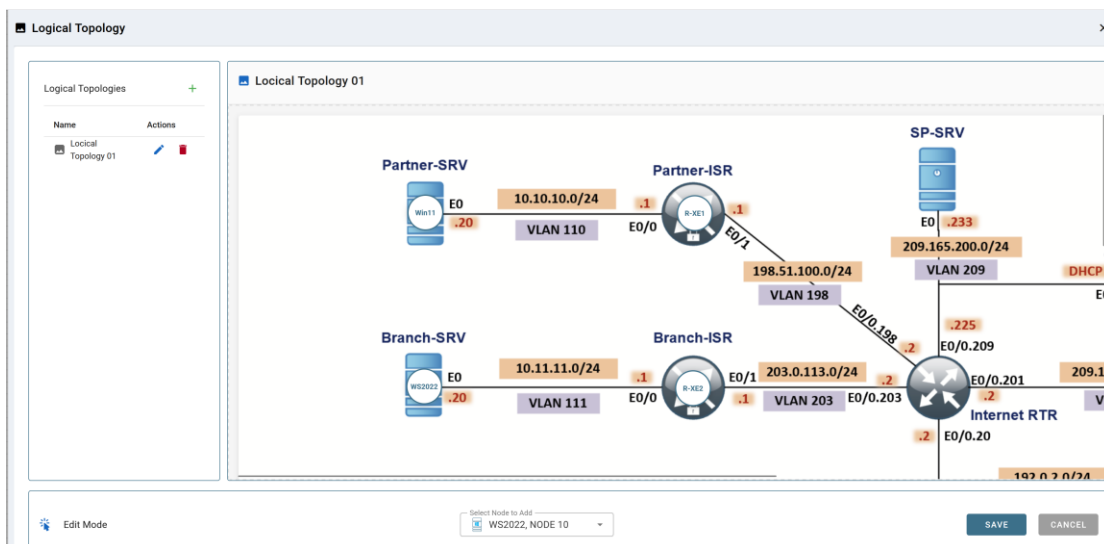

Step 5: OPTIONAL. You can also add a mapping for a device external to your EVE server in order to telnet, VNC, or RDP to it. This way you can open sessions to all your devices (whether external or internal) in one place.

Select from menu: CUSTOM Node, Node outside lab

And map with node on topology.

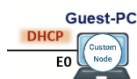

Change image map adding protocol, IP.

Custom URL:

Step 6: Save your mapping and refresh the browser with F5.

10.2.3 Delete topology or mapping

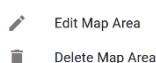

To delete a single node mapping, right click on node mapping circle and click "Delete."

To delete the entire custom topology, click delete.



10.3 Multi-configuration sets export feature

Eve Professional/Learning Center includes a "Multi-configuration Set" feature that allows you to save and manage multiple sets of configurations in a single lab. The "Configuration Export" and "Startup-configs" features will allow you to set these saved configurations as startup configs for your nodes when they boot.

IMPORTANT NOTE: Before you start using the "Multi-configuration Set" feature, you must complete at least one configuration export.

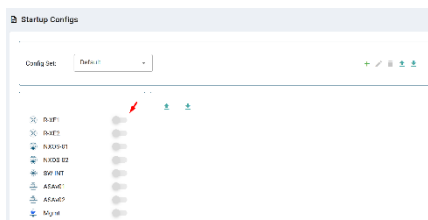

Nodes will be greyed out without the option to enable "Startup-configs" until you complete at least one configuration export for each node.

Node boot order:

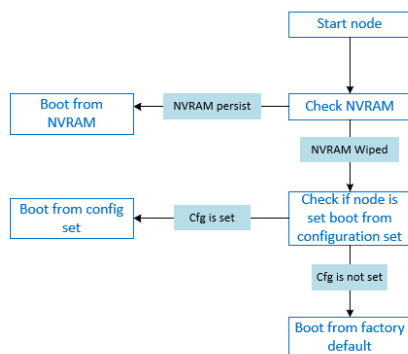

NVRAM: NVRAM is used as writable permanent storage for the startup configuration. During the boot process, the node will always check NVRAM for a saved configuration. Saving the configuration to NVRAM requires a vendor specific command. Cisco: copy run startup (wr), Juniper: commit, etc. It is **MANDATORY** to save a node's configuration before you can export it.

Exported configuration: A node configuration that has been exported from the node. It can be used to backup configurations or to set them as startup-configs.

Wipe node: Wiping a node will erase the NVRAM (running config) or the temporary image snapshot, depending on the type of node. Upon a successful wipe, the node will boot with the factory default configuration or the configuration included in the base image you are using. If

you have the “Startup-config” feature enabled for the node, then it will boot with the chosen config set. You must wipe a node after changing certain node template settings like the image or startup-config. You also must wipe the node the first time you want to enable the “Startup-config” feature.

Factory default configuration: The base configuration that is applied from the manufacturer.

10.3.1 Supported nodes for configuration exports

- Cisco Dynamips all nodes
- Cisco IOL (IOS on Linux)
- Cisco ASA
- Cisco ASA v
- Cisco CSR1000v
- Cisco Catalyst 8000v
- Cisco Catalyst 9000v
- Cisco Nexus 9K
- Cisco vIOS L3
- Cisco vIOS L2
- Cisco Viptela vEdge, vSmart, vBond, till version 18.4 only, version 19.x and later is not supported due implemented password setup feature on the first boot.
- Cisco XRv
- Cisco XRv9K
- Juniper VRR
- Juniper vEX
- Juniper VMX
- Juniper vMX-NG
- JunipervQFX
- JunipervSRX
- Juniper vSRX-NG
- Mikrotik
- PFsense FW
- Timos Alcatel
- vEOS Arista
- Aruba CX Switch

10.3.2 Startup config management

10.3.2.1 Global commands

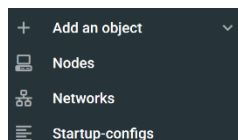

Configurations can be managed via the “Startup-configs window which can be accessed from the sidebar menu while you are on the Topology page.

Topology page, More Options:

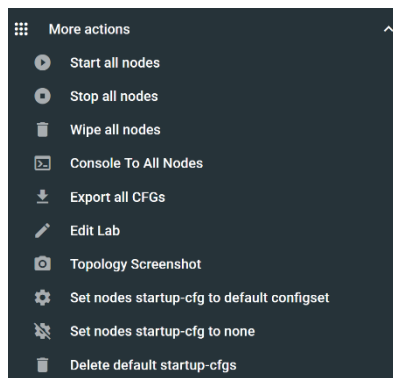

Export all CFGs – Exports all supported node configurations.

Set nodes startup-cfg to default configset- Sets all supported nodes to boot from the default configuration set.

Set nodes startup-cfg to none - Sets all supported nodes to boot from NVRAM configuration.

Delete default configuration set. **Warning**, this will delete your exported default configuration set for all nodes.

10.3.2.2 Individual node commands

Select node, right click

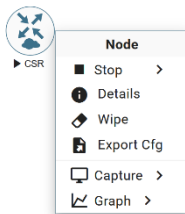

Wipe: Wipes the NVRAM for a single node

Export CFG: Exports the configuration for a single node

10.3.2.3 Multiple selected nodes commands

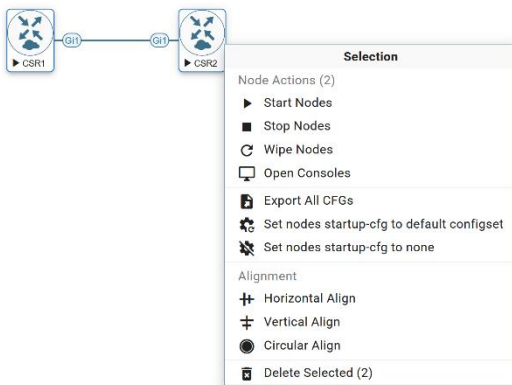

Wipe Nodes: Wipes the NVRAM for selected nodes

Export all CFGs: Exports the configuration for selected nodes

Set nodes startup-cfg to default configs set: Set selected nodes to the default config set

Set nodes startup-cfg to none: Set nodes to boot from NVRAM or from factory default if wiped.

Delete nodes startup cfg: Delete selected node's startup cfg. (clean default set)

10.3.2.4 Startup-configuration window

No configuration exports or manual configs loaded for nodes

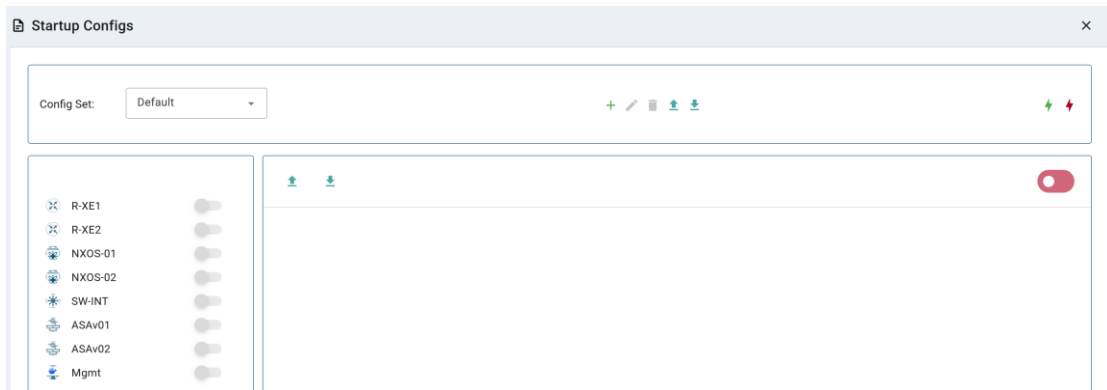



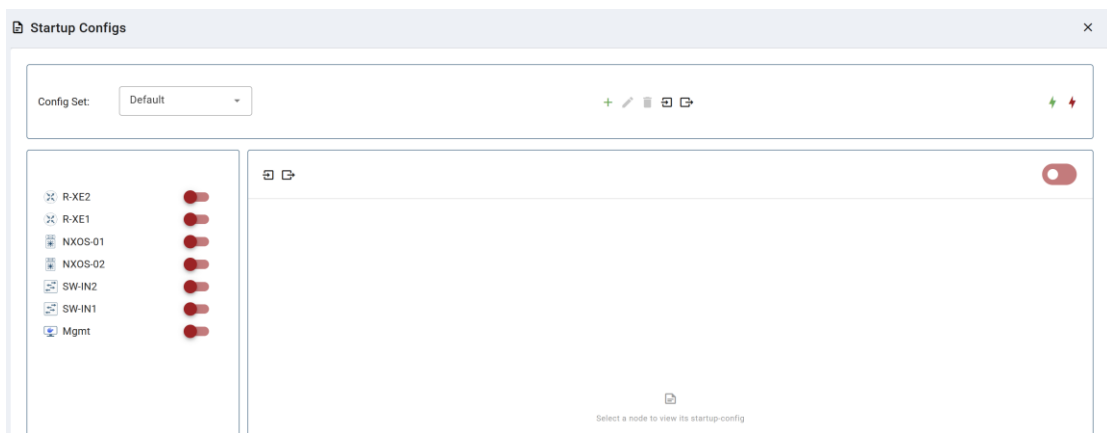

Startup-configs are exported and the “Configuration Export” feature can be used.



10.3.2.5 Startup-config window information

	<p>Config set menu</p>
	<p>No configuration is available for node. Grey node</p>
	<p>Configuration persist but it is disabled. Node will boot from NVRAM or factory default if it is wiped</p>
	<p>Configuration persists and node will boot from the configuration after being wiped</p>
	<p>+ Add new config set.</p>
	<p>Name the new config set. The Default Config Set cannot be renamed.</p>

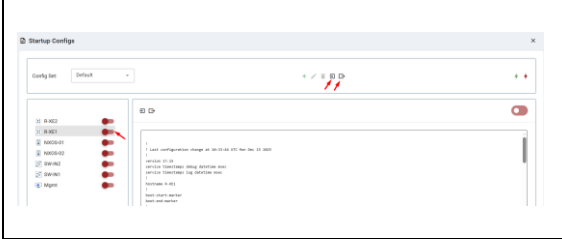
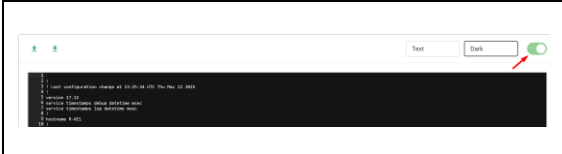
	<p>Select a Config Set and delete it. You cannot delete the Default Config Set. The Default configuration set can be cleaned using the sidebar / More options / Delete default configuration set</p>
	<p>Upload configuration set from your local PC, Download configuration set to your Local PC</p>
	<p>Apply Config Set button: Sets all nodes to boot from the chosen config set.</p>
	<p>Config Reset button: Sets all nodes to boot from none. Node will check boot order. If the Wipe function is used, nodes will boot from factory default.</p>
	<p>Individual node export or import configuration. Configuration export/import file format is .txt.</p>
	<p>Ace Editor. Different vendor configuration edit option. Just Text visual format.</p>

10.3.3 Export Default configuration set

! NOTE: The default configuration set is hardcoded. It is mandatory to export a nodes config before you can start building custom configuration sets.

Lab Example:

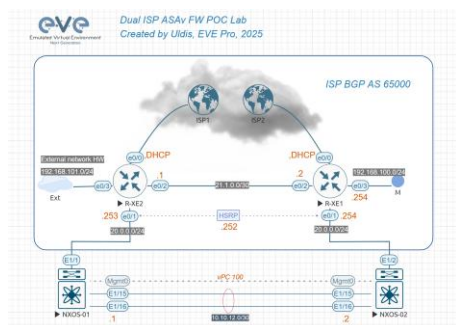

Step 1: **MANDATORY:** Configure your nodes and make sure you applied the vendor specific command to save the running configuration to NVRAM. If you do not save the configuration, it

will not be exported and in the notification area, you will receive an error message stating the node cannot be exported.

In this example the nodes have been configured with hostnames only and the configurations have been saved to NVRAM.

Step 2: Chose any method to export configurations to the Default Config Set. You can use export a single node, a group of nodes, or all nodes. Only supported nodes configurations will be exported.

Step 3: In the example below a group of nodes were selected to export configurations.

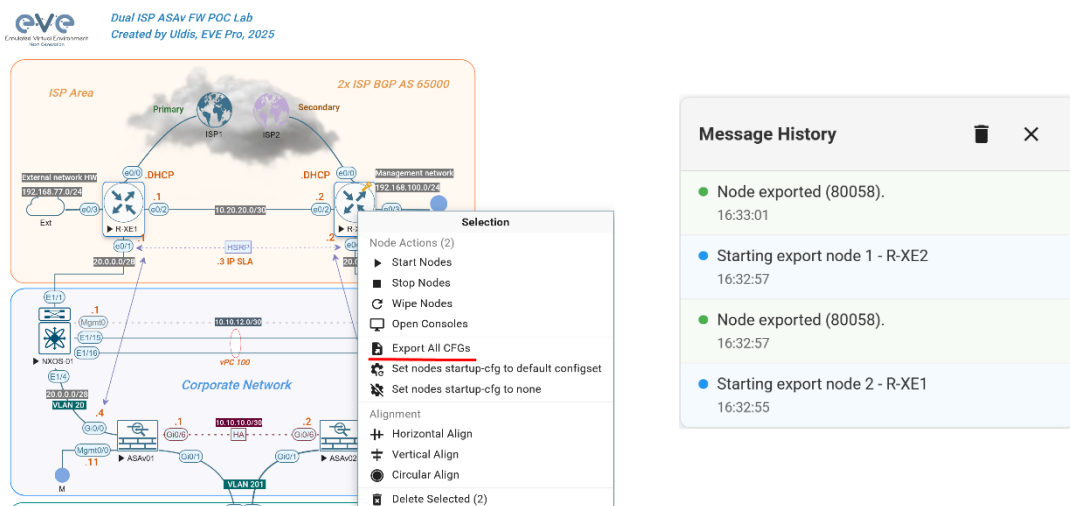

Default configuration set is completed. The notification area will display Green message when complete.

⚠ NOTE: you can configure your nodes with your preferred configuration and make it the default configuration set.

10.3.4 Boot nodes from exported Default config set

Step 1: Stop all nodes

Step 2: Open sidebar and click Startup-configs. Make sure your config is set to default and the nodes config switch is green (switch on/off beside node). Press the green “Apply Config Set” button (Set all nodes to selected config set) and all your nodes will boot with the default config set after wiping them.

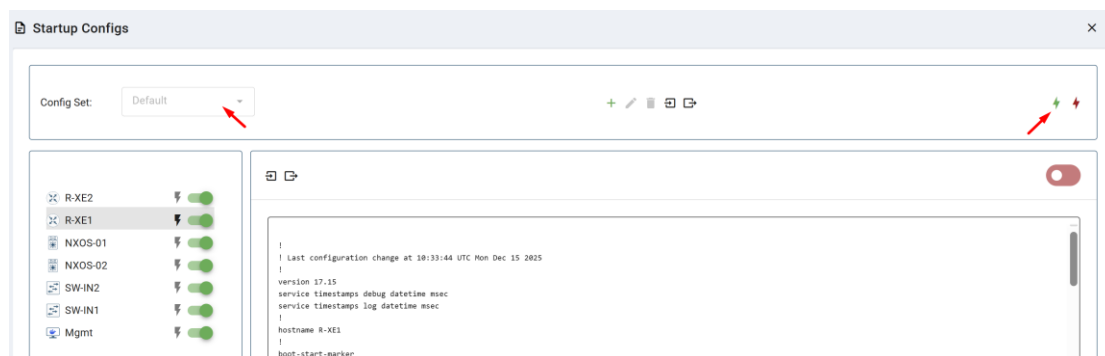

Step 3: Wipe nodes. For more information refer to section 8.1.3

Step 4: Start nodes

10.3.5 Export new custom config set

This section will describe how to create a new custom configuration set for the same example above.

⚠ Make sure your nodes are running and booted from the default set.

Step 1: Create new custom named (e.g. "IP Addressing") configuration set, Press Add new config set.

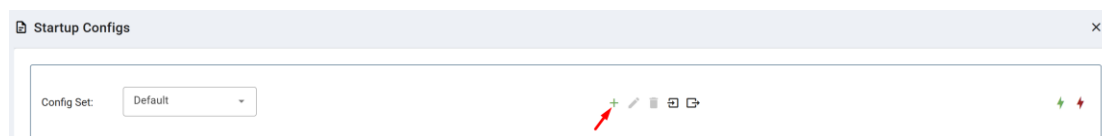

Name it and press Save.

+ New Config Set

Name

CANCEL SAVE

The new configuration set is created.

⚠ NOTE: It will duplicate the default configuration set under your IP Addressing config set.

Step 2: Select newly created Config set IP Addressing and hit the green confirm button (Set all nodes to selected config set) on the right.

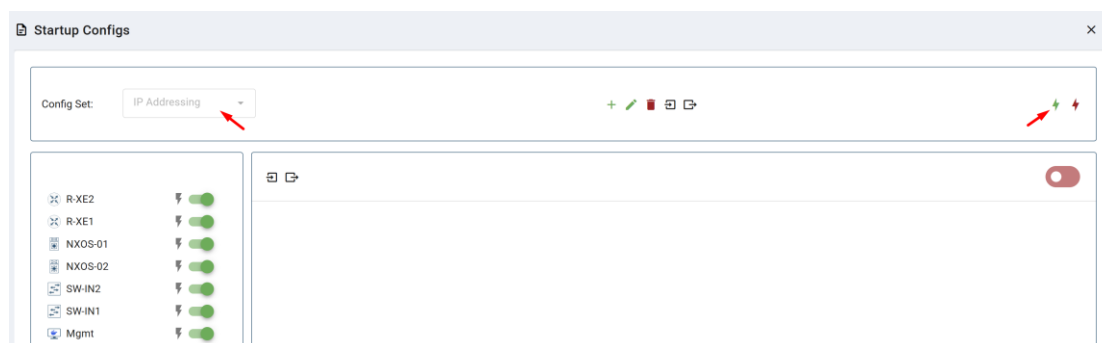

Step 3: Make sure your nodes have the Startup-config slider switched to "ON" and verify the config set menu has the "IP Addressing" set selected.

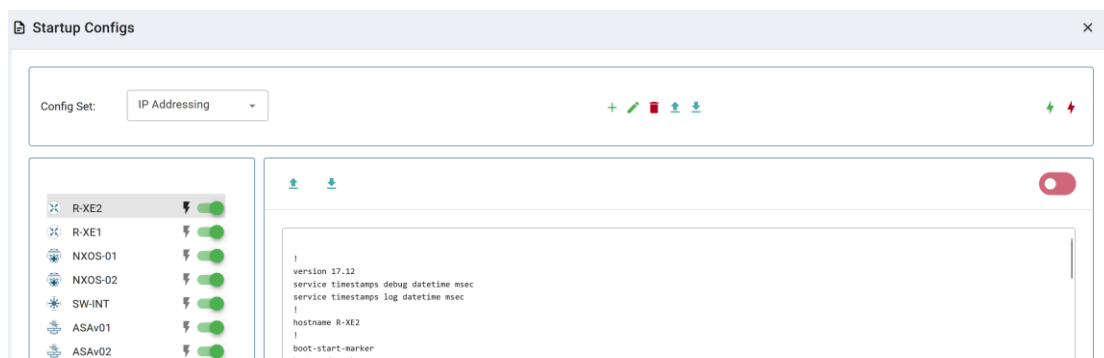

Step 4: Return back to your lab and continue configuring nodes until your preferred configuration is complete. In this Example, the IP addresses are configured on the nodes.

Step 5: **IMPORTANT:** YOU MUST save the configuration on all nodes, even if the configuration was not changed.

Step 6: Use any method (individual, group or all) to export the new configurations to the IP Addressing set.

Step 7: You can verify that the configs were exported by re-opening the “Startup-config” window.

Make sure the correct config set is selected, and check if the configuration is exported for the node or nodes.



Repeat steps 1-7 of this section for the next configuration set.

10.3.6 Edit exported configurations

It is possible to edit your configurations for the nodes manually.

Step 1: Select a config set and apply it with the green confirm button (Set all nodes to selected config set) on the right.

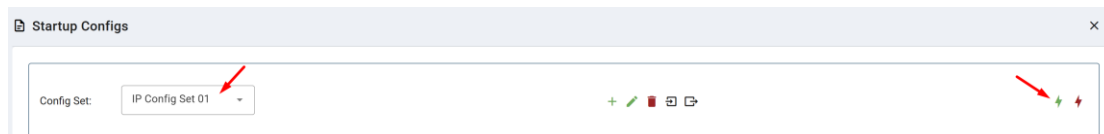

Step 2: Select the node you want to edit the configuration of and make your changes. Click “Save” when you are finished.

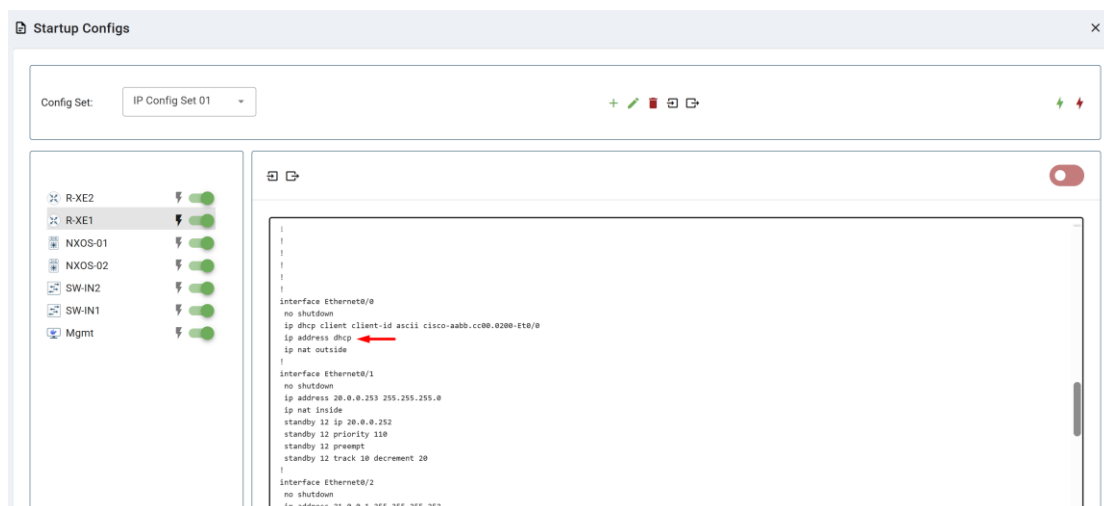

Step 3: Apply the config set to all nodes with the green “Apply Config Set” button on the right (Set all nodes to selected config set).



⚠ NOTE: you can manually copy/paste any configuration into the config set editor and apply it to your node. Make sure your configuration interfaces match the lab node’s interface names.

10.3.7 Set lab to boot from config set

To set your lab nodes to boot from the exported configuration, follow the steps below:

Step 1: Wipe nodes. Refer to section 8.1.3 for information about wiping nodes and the order of operations during boot.

Step 2: Open the “Startup-configs” window from the left sidebar.

Step 3: Select your preferred config set and apply it by pressing the green “Apply Config Set” button on the right (Set all nodes to selected config set).  



Step 4: Start nodes.

10.3.8 Set lab to boot from none

To reset your lab nodes’ configuration to factory default, follow the steps below:

Step 1: Wipe nodes. Refer to section 8.1.3 for information about wiping nodes and the order of operations during boot.

Step 2: Open the “Startup-config” window from the left sidebar

Step 3: Press the red “Config Reset” button on the right (Set all nodes to no startup-config).  

Step 4: Start nodes

10.3.9 Delete a config set

Select the config set you want to delete and click the “Delete” button. You cannot delete the default config set.

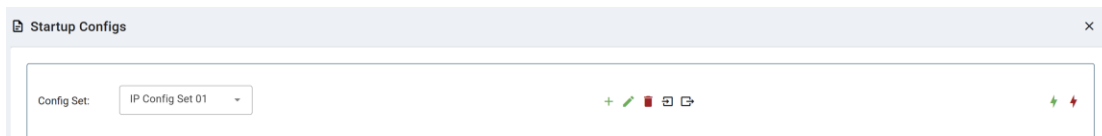

10.3.10 Rename a config set

Step 1: Select the config set you want to rename. Chose Edit and change the name and hit “Save.” You cannot rename the default config set.

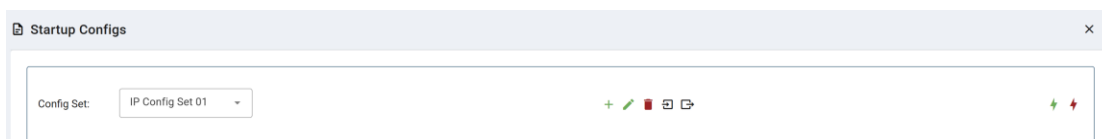

10.3.11 Export a config set to your local PC

It is possible to export configuration sets to your local PC.

Step 1: Select the config set you wish to export.

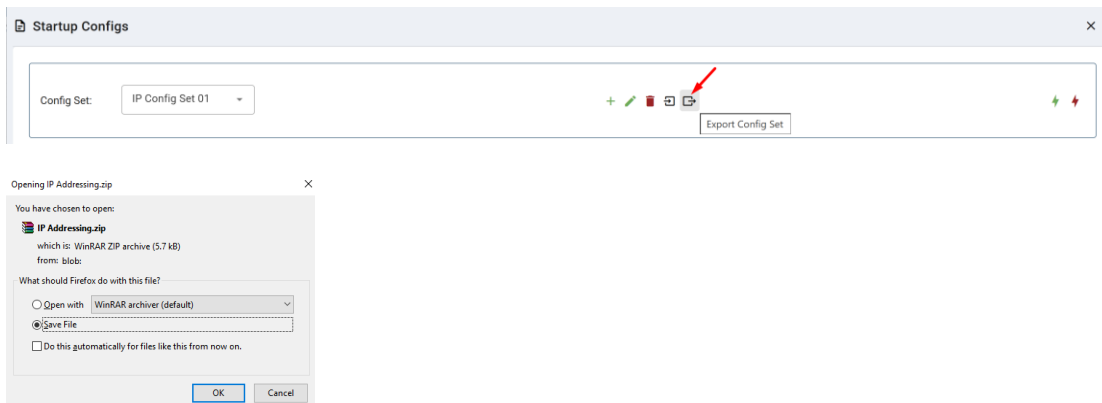

Step 2: Save it on your local PC.

NOTE: You can open this archive and edit your node configs manually. Archived configs are saved in txt format. After editing you can archive it back to .zip format and import it in EVE.

10.3.12 Import config set from local PC.

It is possible to import config sets to your lab.

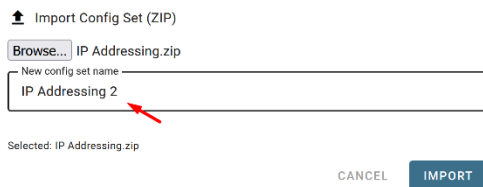

Browse to the file on your PC, select the archive or config set and upload it.

You must set new config set name to avoid duplication with your existing config sets.

10.3.13 Export a single nodes config to your local PC

Open the “Startup-configs” window from the Side bar. Select the node that you want to export the configuration of and click the “Export” button.



10.3.14 Import a single nodes config from your local PC

Open the “Startup-configs” window from the sidebar. Select the node that you want to import the configuration to and click the “Import” button. Browse to the file on your local PC and click “Upload.”

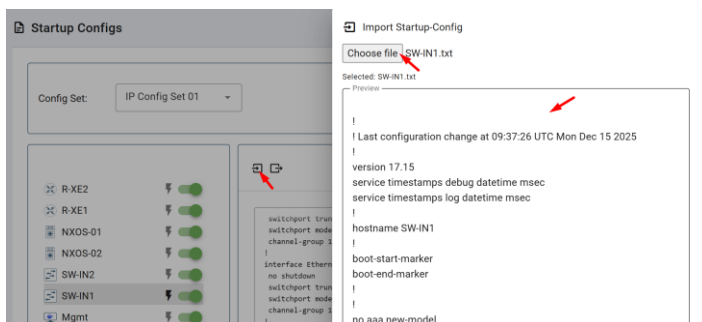

NOTE: The configuration must be in txt file format.

10.3.15 Set lab nodes to boot from different config sets

The “Multi Configuration set” feature allows you to set nodes to boot from different config sets in the same lab.

Option 1: Open the “Nodes” list from the left sidebar. Choose your node and select a config set from the dropdown. Stop the node, wipe it and start it again. Your node will boot from the selected config set. Use scroll line to see more options for nodes. Select more item per page if you want see more lab nodes.

Configured Nodes Filter by Status: All

Lab Assigned Resources (Running/ Total) vCPU: 0/ 18 RAM: 2/ 64 GB HDD: 0.00 GB Total Resources: vCPU 24 - RAM 31.34 GB Showing: 10 of 10 nodes

ID	NAME	SATELLITE	TEMPLATE	BOOT IMAGE	CPU	CPU USAGE	RAM USAGE	CPU LIMIT	IDLE PC	ACTIONS
1	R-XE2	master	iso1	x86_64_cfb_linux-adventureprise9-ms.bin	n/a	2.0%	18.3%	n/a	n/a	[Stop] [Refresh] [Edit] [Delete]
2	R-XE1	master	iso1	x86_64_cfb_linux-adventureprise9-17-15-01-ms.bin	n/a	5.2%	11.1%	n/a	n/a	[Stop] [Refresh] [Edit] [Delete]
3	NXOS-01	any	nxosv9k	Images not available	2	0.0%	0.0%	<input type="checkbox"/>	n/a	[Stop] [Refresh] [Edit] [Delete]
4	NXOS-02	any	nxosv9k	Images not available	2	0.0%	0.0%	<input type="checkbox"/>	n/a	[Stop] [Refresh] [Edit] [Delete]
5	SW-IN2	any	iso1	x86_64_cfb_linux_2-adventureprise9-17-15-01-ms.	n/a	0.0%	0.0%	n/a	n/a	[Stop] [Refresh] [Edit] [Delete]
6	SW-IN1	any	iso1	x86_64_cfb_linux_2-adventureprise9-17-15-01-ms.	n/a	0.0%	0.0%	n/a	n/a	[Stop] [Refresh] [Edit] [Delete]
8	Mgmt	any	docker	eve-gui-server:latest	2	0.0%	0.0%	n/a	n/a	[Stop] [Refresh] [Edit] [Delete]
9	Win11	any	wIn	win-10-x86-22H2v1A	4	0.0%	0.0%	<input type="checkbox"/>	n/a	[Stop] [Refresh] [Edit] [Delete]
10	WS2022	any	wInserver	Images not available	4	0.0%	0.0%	<input type="checkbox"/>	n/a	[Stop] [Refresh] [Edit] [Delete]
11	FTD-FW	any	ftd7	Images not available	4	0.0%	0.0%	<input checked="" type="checkbox"/>	n/a	[Stop] [Refresh] [Edit] [Delete]

Items per page: 10 1-10 of 10

Option 2: Stop the node, right-click on the node and click “Edit.” Select your preferred config set for the node and click “Save.”

Startup configuration

IP Addressing

10.3.16 Lab config script timeout

Lab config script timeout is used when nodes are waiting to boot from a config set. The node will literally wait during boot until the configuration is applied from the config set.

Hit “More actions” and then “Edit lab” from the sidebar. Set the config script timeout in seconds. By default, this timer is set to 600 seconds for new labs.

NOTE: For heavy labs and nodes with long configurations, you can raise this timer to 600 seconds or higher.

Config Script Timeout: 300

10.4 Lab Timer

For self-controlled lab timing, EVE Pro has integrated a “Lab Timer” feature.

10.4.1 Set the Lab Countdown Timer

Step 1: Click “More Options” and then “Edit Lab” from the sidebar.

Step 2: Set the “Lab Countdown Timer” in seconds for the time you wish to display on the topology and confirm by clicking “Save”. 7200 seconds = 120 minutes.

Config Script Timeout: 600

Lab Countdown Timer: 7200

Step 3: To start your lab, be sure all nodes are running.



Step 4: Hit **“Lock Lab”** from the sidebar. A red sign means that the lab is locked.

Step 5: Countdown timer will start



10.4.2 Stop the Lab Countdown Timer

Step 1: Click **“Unlock Lab”** Grey means that the lab is unlocked.

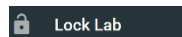

⚠️ NOTE: The lab timer **does not** stop nodes or disconnect sessions from the lab.

10.5 Lab Tasks

Lab task or workbook creation feature.

10.5.1 Creating a new simple task

Step 1: On the side bar click on **“Lab Task(s)”** and open the Lab Task(s) management window.

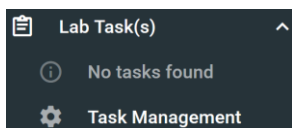

Step 2: Click on the **NEW TASK** to create a new task. Enter the name of the task name and click on **“Create”** to create the task.

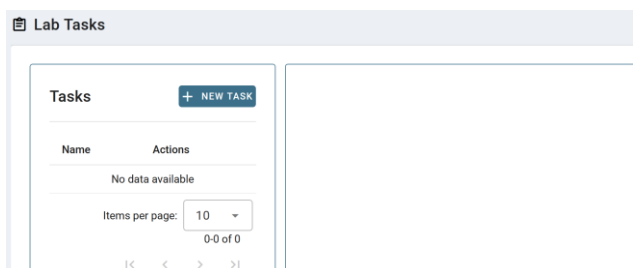

10.5.2 Edit a simple task

Step 1: Select the newly created task and press the **EDIT**.

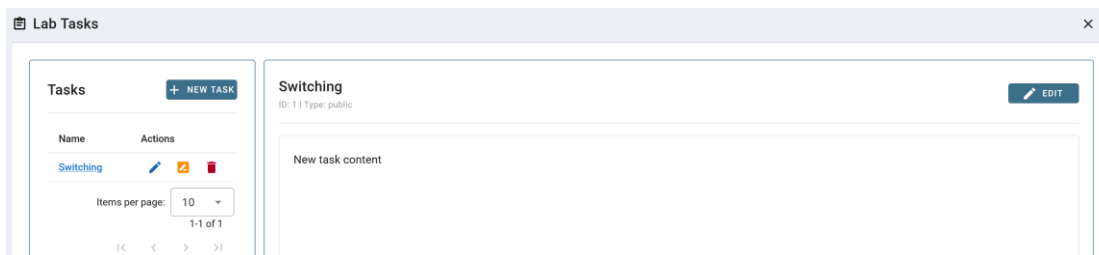

Step 2: Use the rich text editor Window to create your Task / Workbook. It is a recommended option to copy/paste task content from MS Word. Save your Task content by clicking on the **“Save”** button.

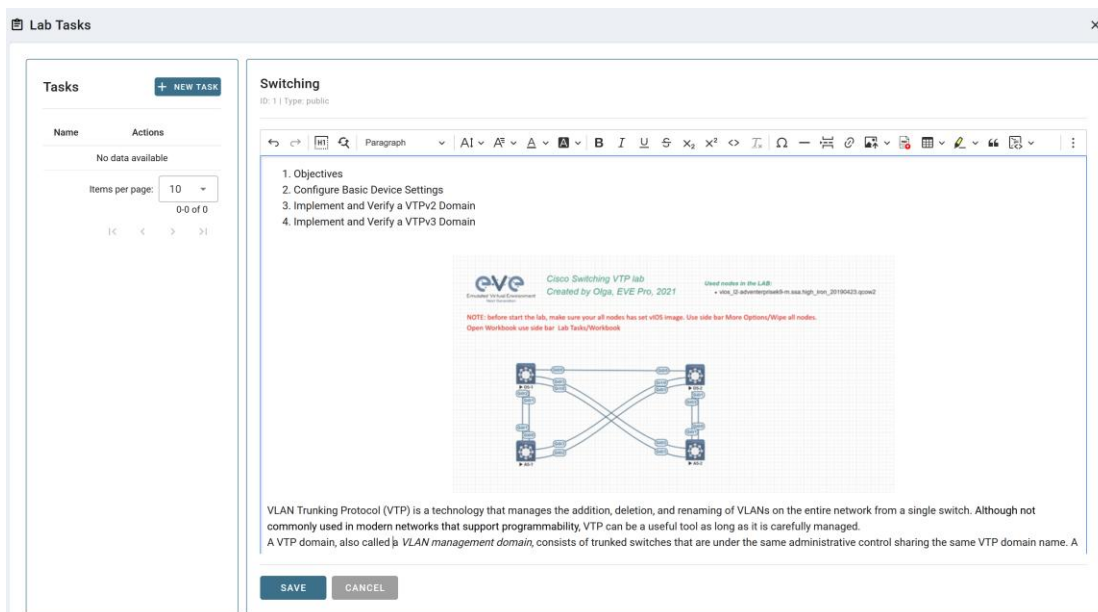

10.5.3 Create a task with your PDF workbook

Step 1: Click on the NEW TASK to create a new task. Enter the name of the task name and click on "Create" to create the task. Press Edit Task.

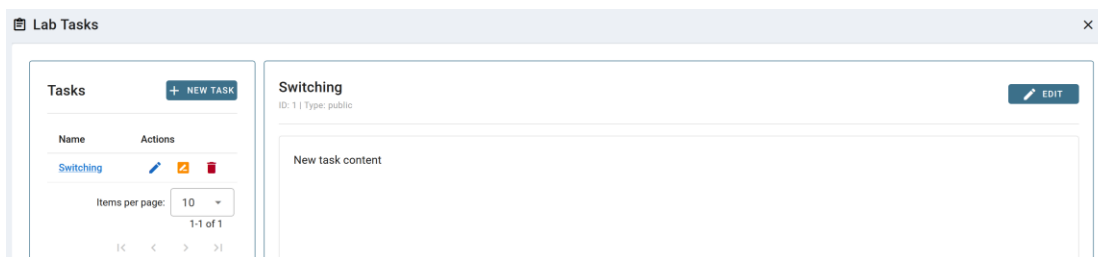

Step 2: Locate PDF button, Press it

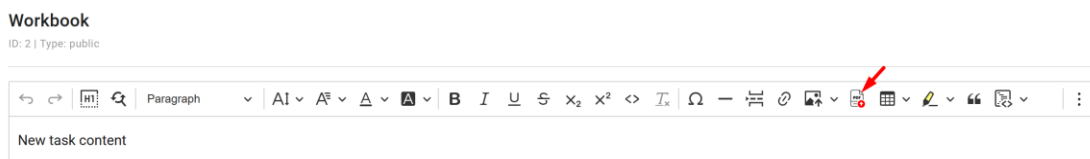

Step 3: Navigate to your pdf document, Press OK.

Step 4: To view your uploaded book, use, Side Bar/Lab Tasks/your task name

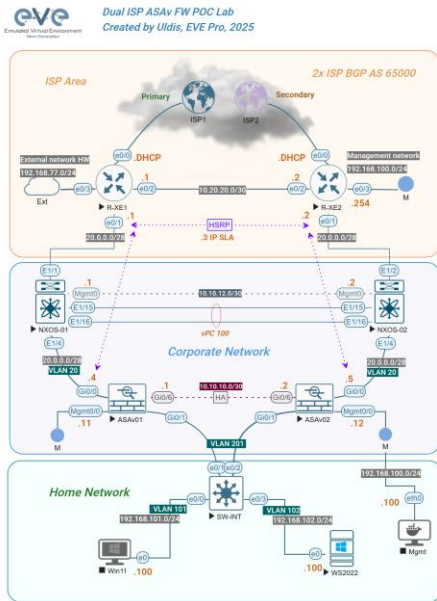

Used nodes in the POC:

- Nexus 9300v64-10.3.3F
- ASAv 9.20.2
- IOL L2 Switch: x86_64_crb_linux_i2-adventerprisek9-ms.bin
- ISP Routers: ix86_64_crb_linux-adventerprisek9-ms.bin
- Host station: Windows 11
- Server: Windows 2022
- Management EVE Docker Server-GUI
- ISP1 Cloud0 bridged to home LAN
- ISP2 Cloud NAT EVE Pro

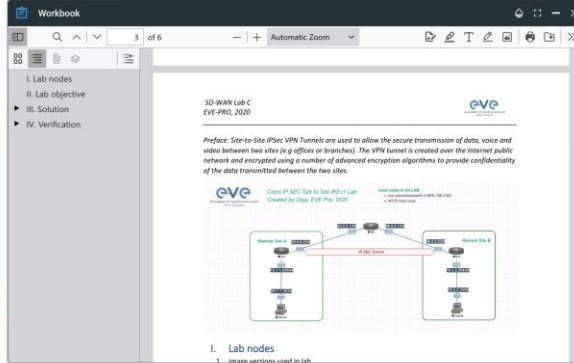

10.5.4 Delete a task

Lab Task(s) ^

- 📄 Switching
- 📄 WRK2
- 📄 Online2
- ⚙️ Task Management

Tasks + NEW TASK

Name	Actions
Switching	✎ 🗑 🗑
WRK2	✎ 🗑 🗑
Online2	✎ 🗑 🗑

Step 1: From the Side bar click on “Task Management”:

Step 2. Click on the delete symbol next to the task name which you want to delete.

11 Traffic detection & filtering

EVE Professional/Learning Center includes a "Traffic Filters" feature. It is unique graphical traffic detection and custom traffic capture filtering, that allows you to set, manage and display on topology different live traffic filters. Traffic Filters feature is associated **pcap** filter syntax. Traffic filter applies and displays live colored link graphic from outgoing interface direction.

11.1 Set traffic filter

Step 1: Open "Traffic Filters" from the left side bar

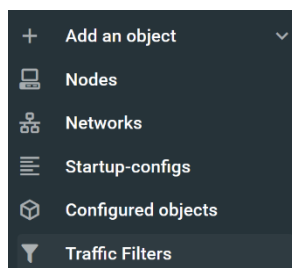

Step 2: Click + ADD FIRST FILTER or + NEW FILTER

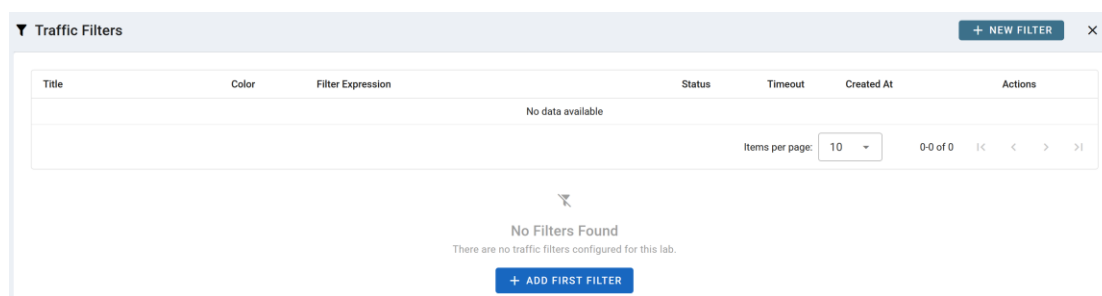

Step 3:

Set **Filter Title**. Example: ICMP to 8.8.8.8

Set **Filter Expression**, PCAP expression syntax examples and details please refer to section: **11.2**

Set **Filter Color** in which it will be displayed on the topology

Set **Status**: Enabled

Set desirable **Timeout** in milliseconds how long you will see on the topology live captured colored traffic.

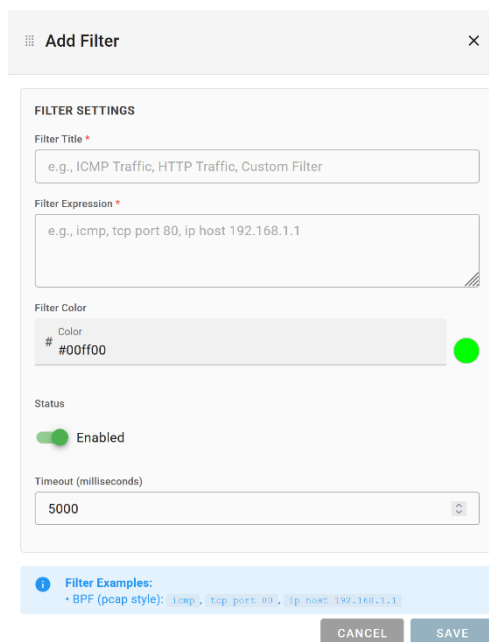

11.2 PACP filtering syntax

11.2.1 PACP GPT Help

EVE-NG Filtering is using PACP expression syntax commands. As really huge help you can use: <https://chatgpt.com/> to ask proper syntax which you want to capture in the EVE topology. Wireshark syntax for filter is the same.

Example to search in GPT chat: Wireshark: Capture ICMP to a Specific Destination IP:

The screenshot shows a ChatGPT interface. The user query is: "Wireshark: Capture filter ICMP to a Specific Destination IP". The response explains that to set a capture filter in Wireshark for ICMP packets destined for a specific destination IP, the following syntax should be used in the Capture Filter field: `icmp and dst host <DESTINATION_IP>`. It also provides an example where the destination IP is 8.8.8.8, resulting in the filter `icmp and dst host 8.8.8.8`.

Example: To capture ICMP packets **sent to** 8.8.8.8 (Google's DNS server), the filter would be:

```
icmp and dst host 8.8.8.8
```

11.2.2 Filter examples

<i>Interesting filter explanation</i>	<i>Expression Syntax/ Single line</i>
Capture all ICMP (IPv4) packets	ICMP
Capture all UDP packets where the source OR destination port is 53	udp port 53
Capture ICMP packets that originate from 192.168.70.28 and are sent to 1.1.1.1	icmp and src host 192.168.70.28 and dst host 1.1.1.1

Capture packets that have an 802.1Q VLAN tag with VLAN ID 201	vlan 201
Capture DNS traffic (UDP port 53), whether the packet is untagged or VLAN-tagged with VLAN ID 201. Combined traffic filter to capture, VLAN 201 and DNS traffic.	udp port 53 or (vlan 201 and udp port 53)
Capture ICMP packets destined to 8.8.8.8, whether they are untagged or tagged with VLAN ID 120	(icmp and dst host 8.8.8.8) or (vlan 120 and icmp and dst host 8.8.8.8)
Capture Slow Protocols (IEEE 802.3ad / 802.1AX LACP, marker, etc.) Capture	ether proto 0x8809
Capture HSRP packets	udp port 1985 and dst host 224.0.0.2

Example: Completed Traffic Filter for Capture ICMP packets destined to 8.8.8.8, whether they are untagged or tagged with VLAN ID 120:

☰ Add Filter
✕

FILTER SETTINGS

Filter Title *

Filter Expression *

Filter Color

Color #

●

Status

Enabled

Timeout (milliseconds)

Filter Examples:

• BPF (pcap style): icmp, tcp port 80, ip host 192.168.1.1

CANCEL
SAVE

Traffic Displayed on the EVE-NG Topology. Colored links visually demonstrate live traffic flow for interesting filter.

Title	Color	Filter Expression	Status	Timeout	Created At	Actions
vPC Nexus Traffic	#4d0a90ee	ether proto 0x8809	Enabled	5000 ms	16/12/2025, 11:42:02	
HSRP Traffic	#a30a0eef	udp port 1985 and dst host 224.0.0.2	Enabled	5000 ms	16/12/2025, 11:41:10	
VLAN 120 and 8.8.8.8 Traffic Flow	#0000ee	(icmp and dst host 8.8.8.8) or (vlan 120 and icmp and dst host 8.8.8.8)	Enabled	5000 ms	16/12/2025, 11:35:45	

Items per page: 10 1-3 of 3

Filter Name	Color	Count	Actions
vPC Nexus Traffic	Purple	609	
HSRP Traffic	Orange	5,443	
VLAN 120 and 8.8.8.8 Traffic Flow	Blue	19,987	

Detailed captured information:

Filter Name	Color	Count	Reset	Zero Packet
VLAN 120 and 8.8.8.8 Traffic Flow	Blue	5.00K	0	5.00K
HSRP Traffic	Orange	0	1.75K	1.75K
HSRP Traffic	Orange	919	835	1.75K

Dual ISP Cisco FTD FW POC Lab
Created by UD, EVE Pro, 2025

Legend and used nodes in the POC:

- Nexus 9300v64-10.3.3F
- Cisco FTD 7.7
- IOL L2 Switch: x86_64_crb_linux_l2-adventureisek9-17-15-01-ms.bin
- ISP Routers: x86_64_crb_linux-adventureisek9-17-15-01-ms.bin
- Host station: Windows 11
- Server: Windows 2022
- Management EVE Docker Server-GUI
- ISP1 Cloud0 bridged to home LAN
- ISP2 Cloud NAT EVE Pro
- Po110 LACP VPC 110 Trunk

Filter Name	Count	Actions
vPC Nexus Traffic	96	
HSRP Traffic	1,075	
VLAN 120 and 8.8.8.8 Traffic Flow	18,107	

```

FTD-FW
-----
Success rate is 100 percent (1000/1000), round-trip min/avg/max = 28-23-40 ms
FTD77# ping 8.8.8.8 rep 1000
Type escape sequence to abort.
Sending 1000, 100-byte ICMP Echoes to 8.8.8.8, timeout is 2 seconds:
-----

```

12 Wireshark capture

All EVE-NG Professional and Learning Centre console types have the integrated Wireshark capture feature for HTML Console and native Wireshark application for Native console.

EVE-NG Professional integrated Docker Wireshark currently supports:

12.1 Native Console Wireshark capturing

Step 1: Right click on the node you wish to capture, choose “Capture” and then the relevant interface. The capture will open in bat file CMD and Wireshark native application sessions.

Native Wireshark for EVE-PRO supports capture ethernet interfaces.

Select the interface frame type which will be captured:

- Ethernet for Ethernet, Fast Ethernet, Gigabit Ethernet.

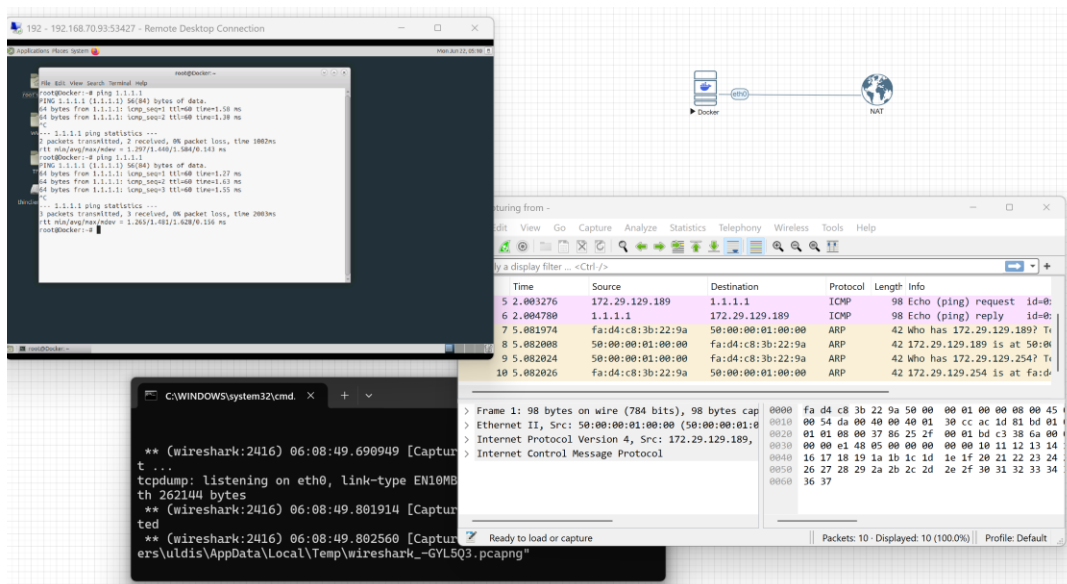

Example: Docker live interface eth0 capture.

12.2 HTML5 Console Wireshark capturing

Step 1: Right click on the node you wish to capture, choose "Capture" and then the relevant interface. The capture will open in an HTML session. EVE-PRO supports capture for ethernet and serial interfaces.

Select the interface frame type type which will be captured:

- Ethernet for Ethernet, Fast Ethernet, Gigabit Ethernet.
- Serial interface frames: HDLC, PPP or Frame Relay.

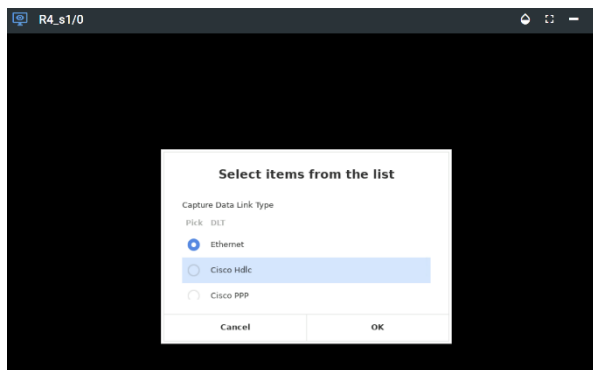

Example: R-XE1 live interface e0/0 capture.

Step 2: To save the captured file to your PC, stop the capture and choose File/Save As

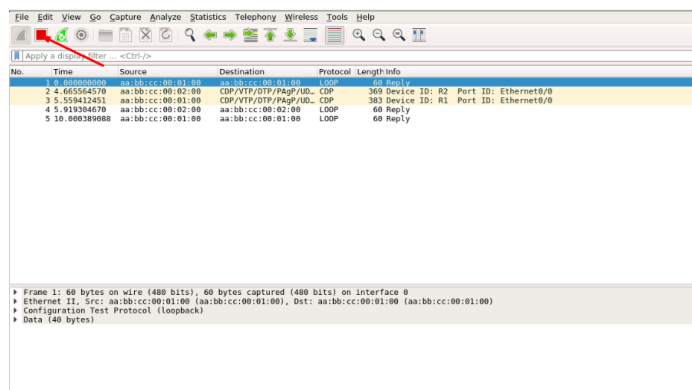

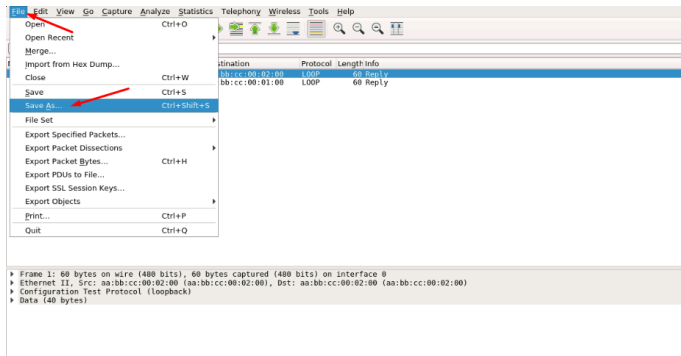

Step 3: Choose the location where you want to save the captured file

IMPORTANT:

/nobody/thinclient_drives/GUACFS/Download

Enter a name for you captured file and press Save.

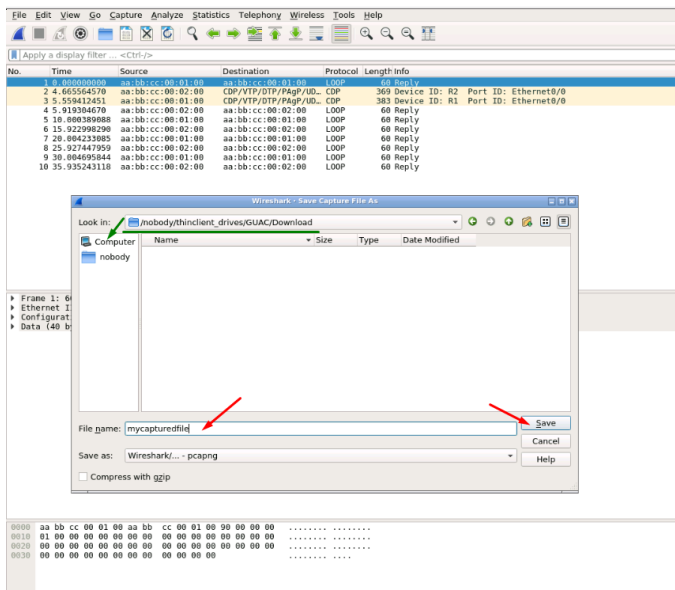

Step 4: A window will open that will allow you to save your captured file on your client PC. If the client PC's browser is set to download automatically, your captured file will be saved in the default browser download folder.

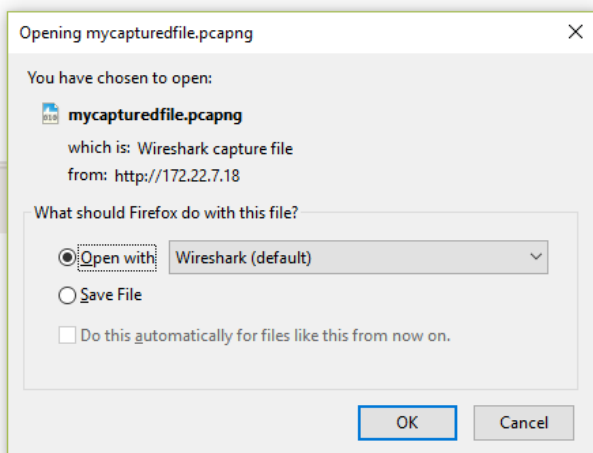

12.3 HTML5 Desktop Console Wireshark capturing

Step 1: Right click on the node you wish to capture, choose “Capture” and then the relevant interface. The capture will open in an RDP session. EVE-PRO supports capture for ethernet and serial interfaces.

Select the interface frame type which will be captured:

- Ethernet for Ethernet, Fast Ethernet, Gigabit Ethernet.
- Serial interface frames: HDLC, PPP or Frame Relay.

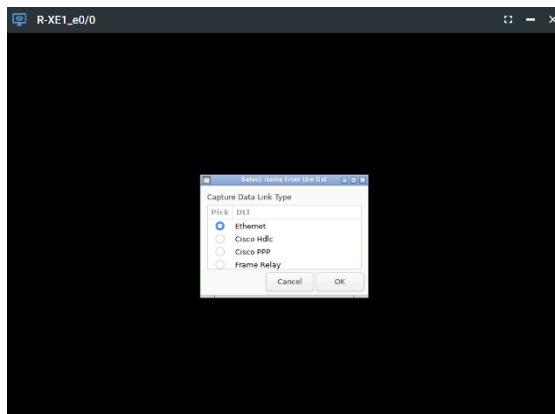

Step 2: Stop capturing with the STOP button.

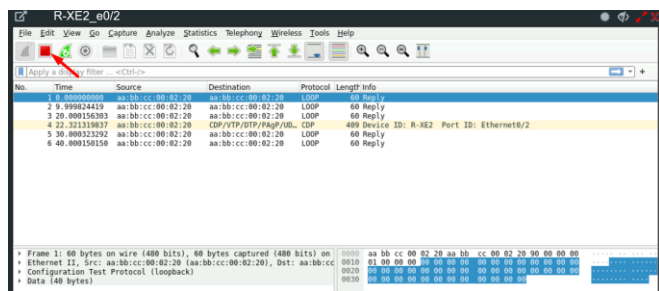

Step 3: Chose File/Save As

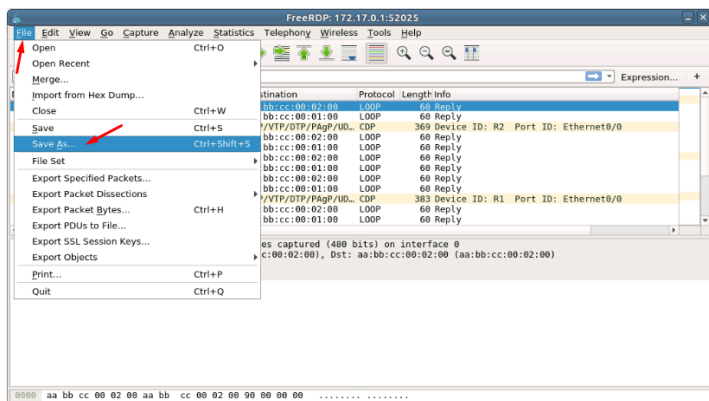

Step 4: Chose the path to save the captured file,

IMPORTANT:

/nobody/thinclient_drives/media/nobody/thinclient_drives/GUACFS/Download/

Enter a name for captured file. Press Save.

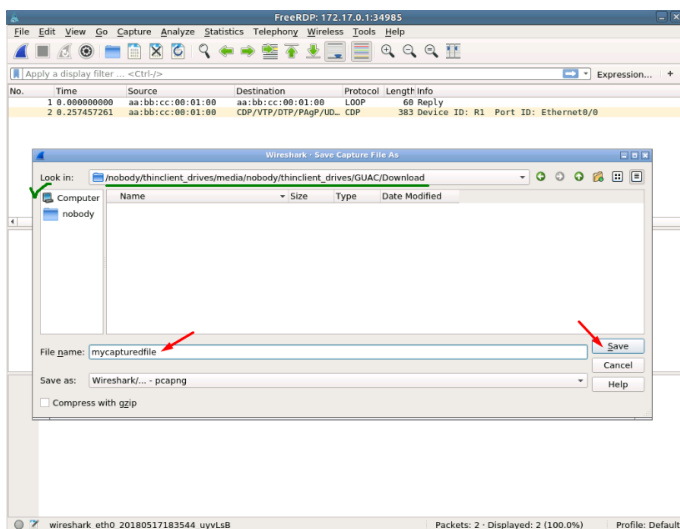

Step 4: A window will open that will allow you to save your captured file on your client PC. If the client PC's browser is set to download automatically, your captured file will be saved in the default browser download folder.

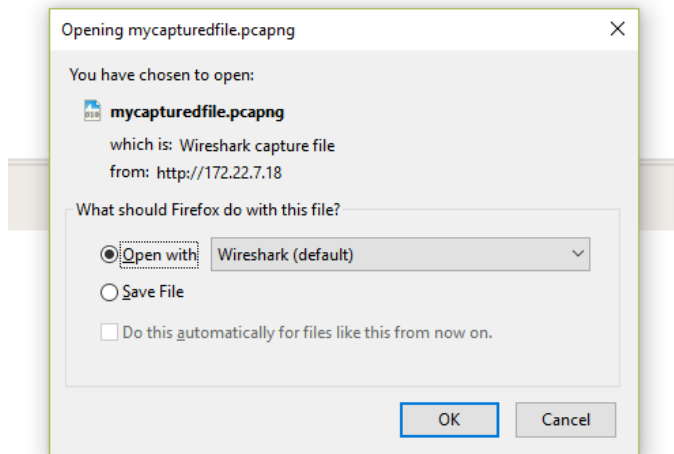

13 Thinclient File Exchange

! NOTE: Thinclient file exchange feature is available for HTML5 or desktop HTML5 consoles only. Make sure you are logged in EVE with one of it.

The Thinclient file exchange feature allows you to transfer files between your native client workstation and the integrated Docker Desktop. It is used when managing EVE via HTML5 consoles. This feature eliminates the need for file transfer software on your client workstation and makes it very easy to import/export labs or download Wireshark captures.

13.1 Thinclient files downloading

The Thinclient file exchange feature allows you to download files from your EVE Server over an HTTP/HTTPS session to your client PC. Examples below will show you how to download exported lab files. This feature is not restricted to just lab files or Wireshark captures. It can be used to download or upload any miscellaneous files you may need.

Example: HTML5 console to server-gui Docker node: We want to export our test.txt file and download it to our client PC over HTML5.

Step 1: Create and save test.txt file on your HTML5 server-gui station.

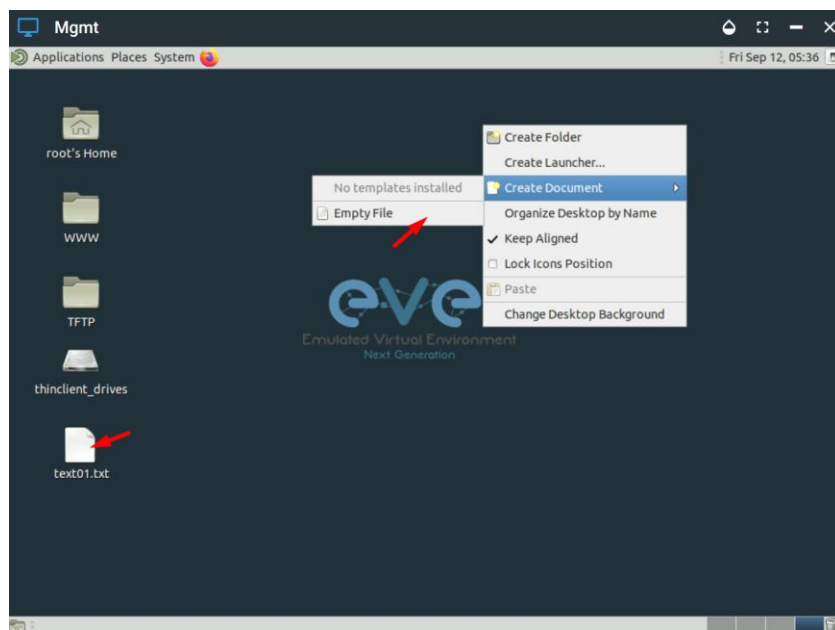

Step 2: Navigate to the desktop of the HTML5 server-gui station and double click **thinclient_drives** and navigate to: **thinclient_drives/GUACFS/Download/**

Step 3: Drag and drop the test.txt file from right to left.

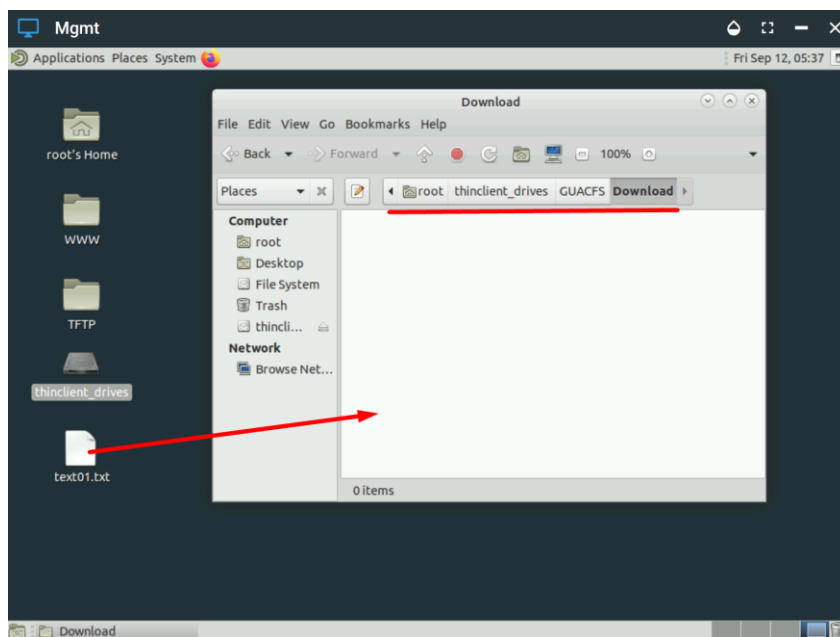

Step 4: A window will open that will allow you to save your captured file on your client PC. If the Native PC's browser is set to download automatically, your selected file will be saved in the browsers default download folder.

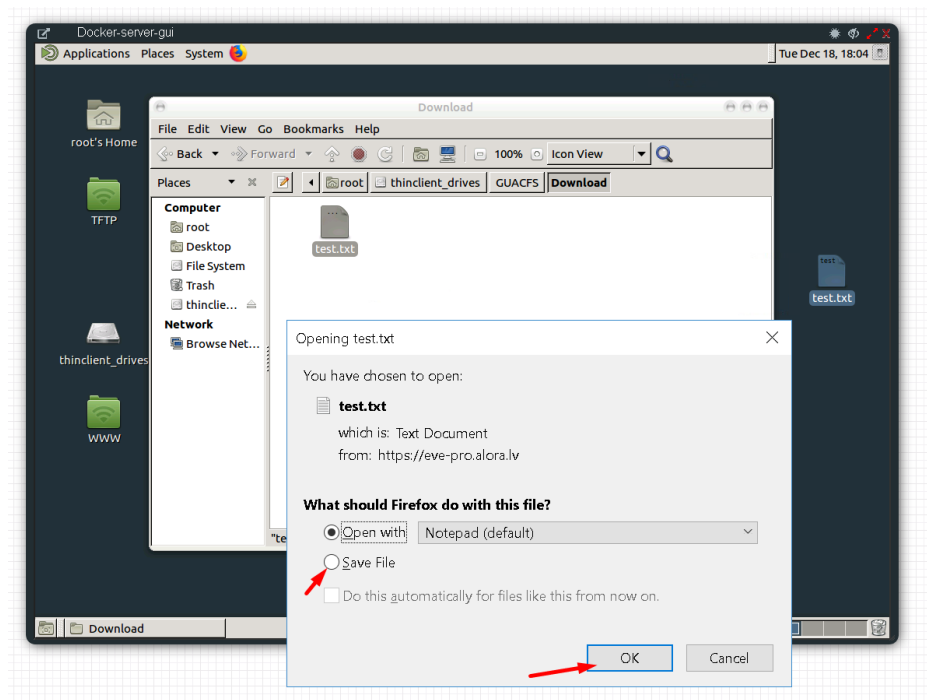

NOTE: Please refer to section [10.5.4](#) for downloading Wireshark capture files from EVE HTML5 consoles.

13.2 Thinclient File upload

Sometimes it is necessary to upload files to your EVE labs. The Thinclient file exchange feature allows you to upload files from your client PC to the EVE HTML5 server-gui station. The

example below will show you how to upload a text file to the EVE HTML5 server-gui station. Any other files can be uploaded the same way.

Step 1: Adjust your browser so that you can see it and the file that you want to transfer.

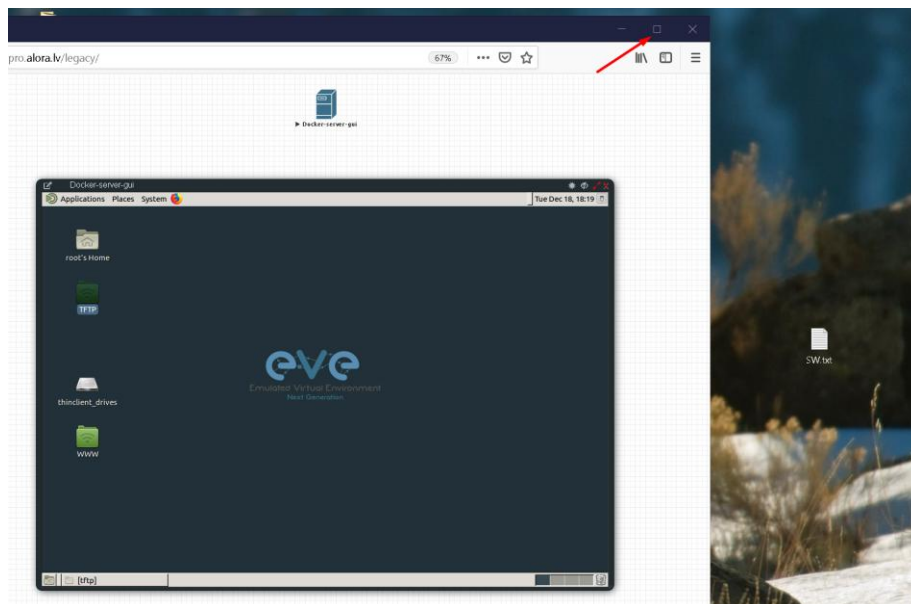

Step 2: On the EVE HTML5 Desktop navigate to: **thinclient_drives/GUACFS/** and drag and drop the file from your client PC to opened location on HTML5 Desktop.

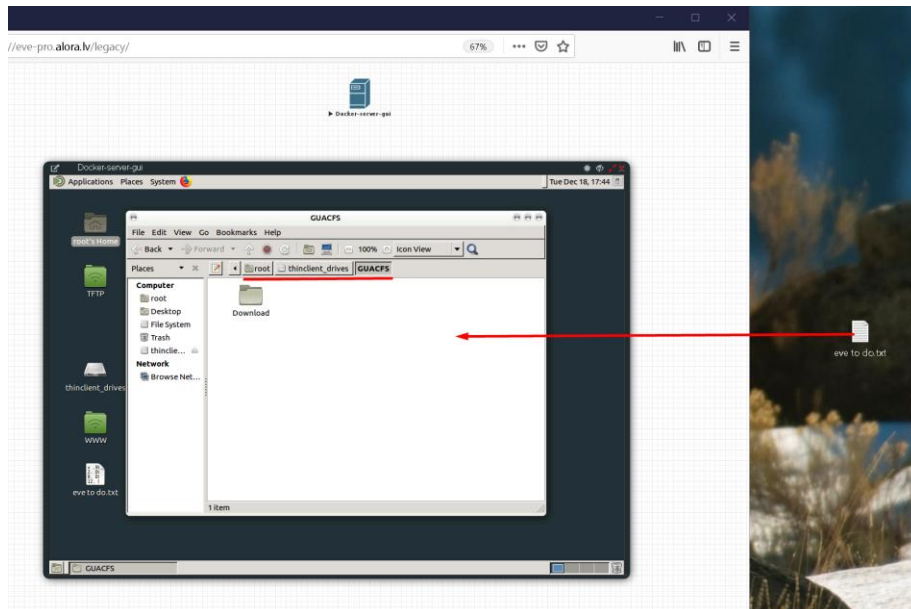

Step 3: Next you will see a notification in the bottom right corner.

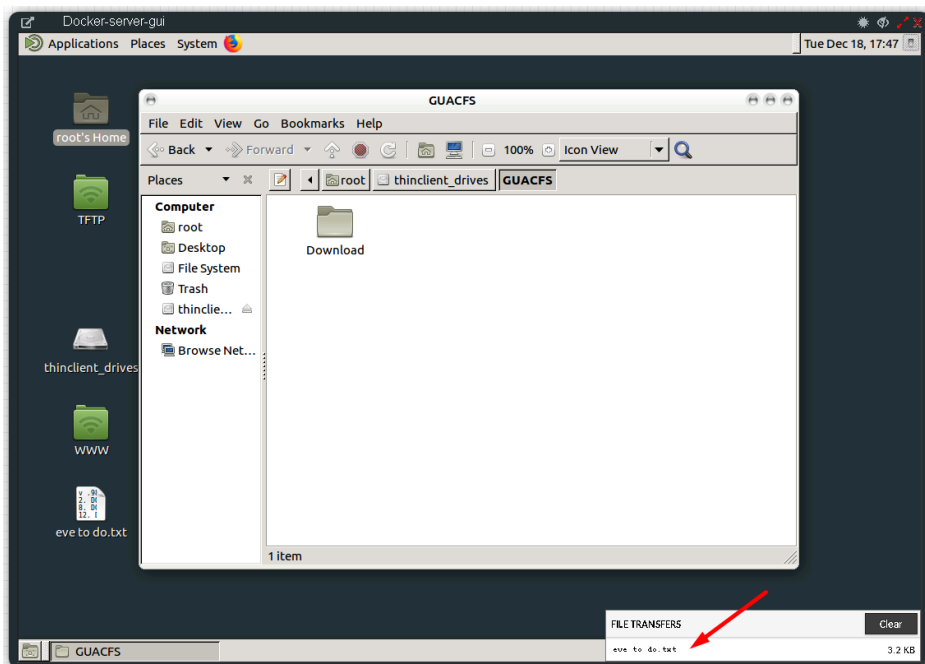

Step 4: To finish the operation and see the uploaded file in the HTML desktop station, press the refresh button. Our Text file SW.txt has been uploaded.

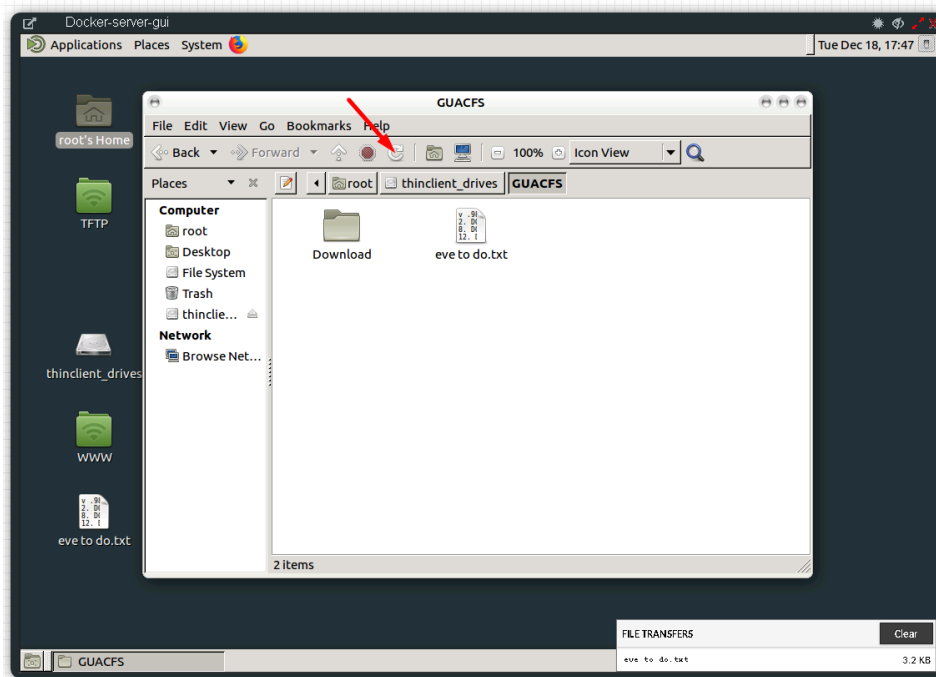

13.3 Other Thinclient file operations

Files that have been uploaded via the thinclient feature can also be transferred to nodes inside your EVE labs via TFTP. In the example below we have uploaded a config file (sw.txt) and would like to transfer it to node R1.

Step 1: Add the **eve-gui-server** docker node to your lab and edit its settings. Set the console type to RDP and configure the IP address settings (DHCP or static) accordingly so that the

docker node can reach the destination node (R1 in this example). For Docker IP addressing please refer to section 14

Step 2: Click on the **eve-gui-server** docker node to open an RDP session.

Step 3: Open the **thinclient_drives** location where you uploaded your file to:

[/thinclient_drives/media/nobody/thinclient_drives/GUACFS/](#)

Next, drag and drop your file to the desktop folder named TFTP.

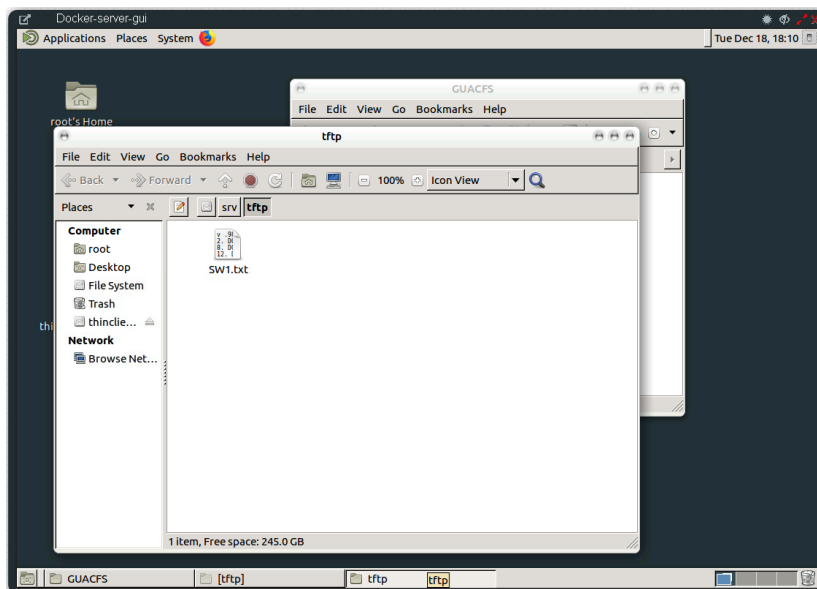
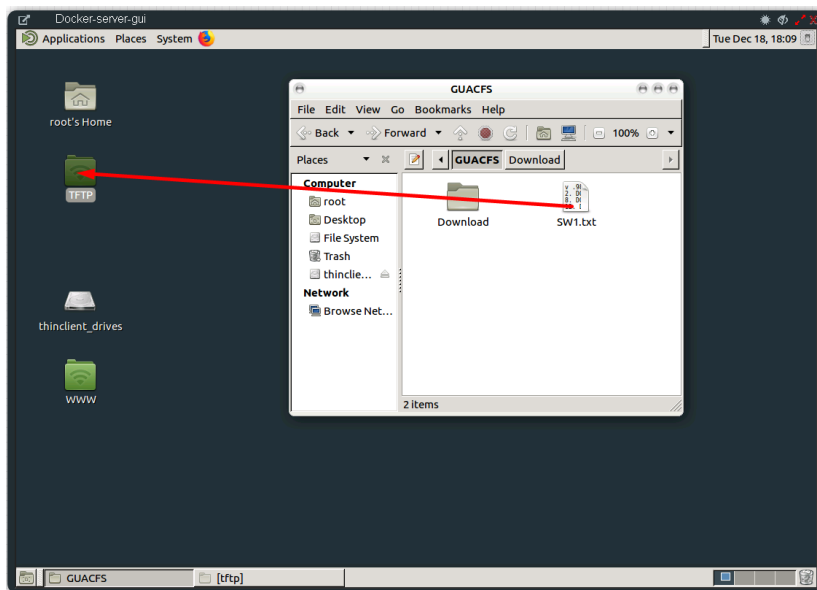

Step 4: Open the destination node's (R1) console and use the tftp command to copy your file:

The image shows a network simulation in EVE-NG. At the top left, a network diagram features a DHCP NAT Cloud (169.254.254.0/24) connected to a NAT instance. This NAT instance is connected to a central router (R1) with IP 10.1.1.0/24. R1 is also connected to another router (R2) with IP 192.168.20.2. R1 has a VLAN 20 SVI20 with IP 192.168.20.1. A host (M1) is connected to R1, and an HTML Desktop is connected to R2. A red arrow points from the NAT instance to the HTML Desktop in the terminal window.

The terminal window shows the following output:

```
1. R1
File Edit View Search Preferences Tabs Help
permst 192.168.20.0 0.0.0.255

R1#sh ip int brief
Interface IP-Address OK? Method Status Protocol
Ethernet0/0 10.1.1.1 YES TFTP up up
Ethernet0/1 192.168.20.1 YES TFTP up up
Ethernet0/2 172.29.129.145 YES DHCP up up
Ethernet0/3 unassigned YES TFTP administratively down down
VVI0 10.1.1.1 YES unset up up
R1#ping 192.168.20.13
Type escape sequence to abort.
Sending 5, 100-byte ICMP Echos to 192.168.20.13, timeout is 2 seconds:
!!!!
Success rate is 80 percent (4/5), round-trip min/avg/max = 1/1/1 ms
R1#copy tftp://192.168.20.13/SW.txt fla
R1#copy tftp://192.168.20.13/SW.txt un
R1#copy tftp://192.168.20.13/SW.txt unix:
Destination filename [SW.txt]?
Accessing tftp://192.168.20.13/SW.txt...
Loading SW.txt from 192.168.20.13 (via Ethernet0/1): !
[OK - 2517 bytes]
2517 bytes copied in 0.018 secs (139833 bytes/sec)
R1#
```

The terminal window also shows a file explorer interface with a file named 'SW.txt' selected. The file explorer shows a tree view with 'root', 'Desktop', 'File System', 'Trash', 'thincle...', and 'network'. The 'network' folder is expanded, showing 'BrowseNet...'. The file explorer also shows '1 item, Free space: 2.6 TB'.

14 Dockers

14.1 EVE integrated docker stations

EVE-NG Professional and Learning Centre edition have integrated Docker stations that allows your server to use its resources more efficiently. Dockers offer the advantage of not having to duplicate processes already running on the host system. With a Docker, you run only the processes you need for the hosted application. In comparison, virtual machines have to run a complete guest operating system, including many of the same processes that are already running on the server host.

⚠ IMPORTANT NOTE: EVE Docker stations for html console access are using network **172.17.0.0/16**. Please avoid use this network on the EVE management or other clouds or interfaces.

14.1.1 Docker Machines

eve-gui-server (default)

- Fully featured Linux workstation with integrated Thinclient. For more information on the Thinclient operation please refer to section **13**.
- napalm
- ansible
- python
- iperf3
- RDP console
- DHCP or Static IP address
- WWW Server (web page home directory www is located on desktop)
- TFTP Server (for access to TFTP server, root/eve or nobody/eve, home directory TFTP is located on desktop)
- FTP server (for access to FTP server, root/eve, home directory for ftp is root)
- Java Integration for ASDM access to Cisco ASA/IPS. For access to ASDM where Java is required, please follow this reference link:

<https://192.168.100.5/admin/public/asdm.jnlp>

Where 192.168.100.5 is the ASA IP for ASDM connection

NOTE: Older ASA require to configure extra SSL encryption to communicate with Java on the docker station. ASA 9.1.5 CLI:

```
ssl encryption aes256-sha1
```

Example: Access to ASA/ ASDM from Docker server-gui station

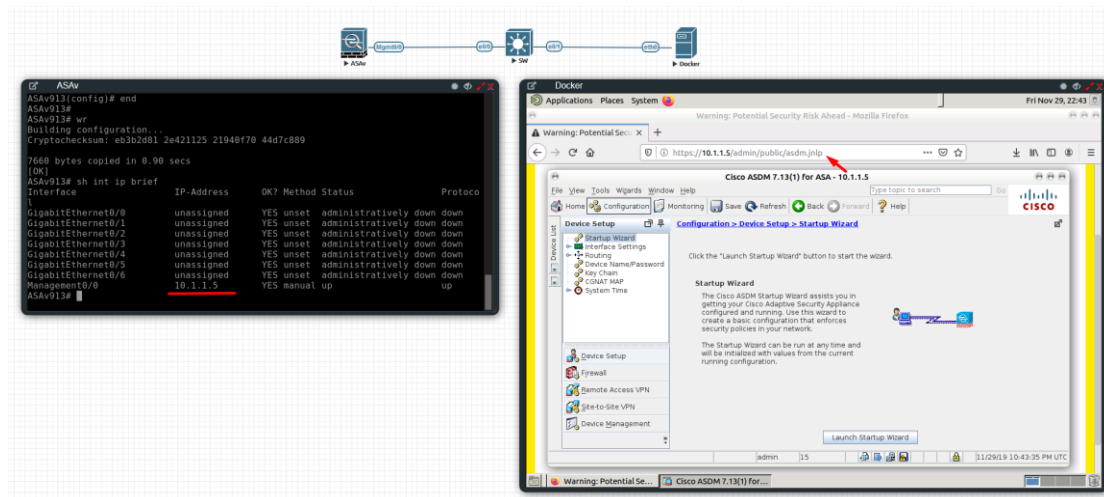

eve-firefox (default)

- A Docker for hosting a Mozilla Firefox browser. Useful for accessing another nodes management interface using http or https. The browser already has Java integrated so that you can utilize GUIs that require it, like ASDM for Cisco's ASA.
- RDP console
- DHCP or Static IP address

eve-wireshark (default)

- Fully featured Wireshark workstation with integrated Thinclient. For more information on the thinclient operation please refer to section 13.
- RDP console

eve-chrome (extra install, section 14.5)

- A Docker for hosting a Google Chrome browser. Useful for accessing another nodes management interface using http or https. The browser already has Java integrated so that you can utilize GUIs that require it, like ASDM for Cisco's ASA.
- DHCP or Static IP address

eve-ostinato (extra install, section 14.5)

- A Docker for hosting a Ostinato 0.9 GUI. Fully featured Ostinato 0.9 packet generator and network traffic generator machine
- DHCP or Static IP address
- Fully featured Ostinato GUI

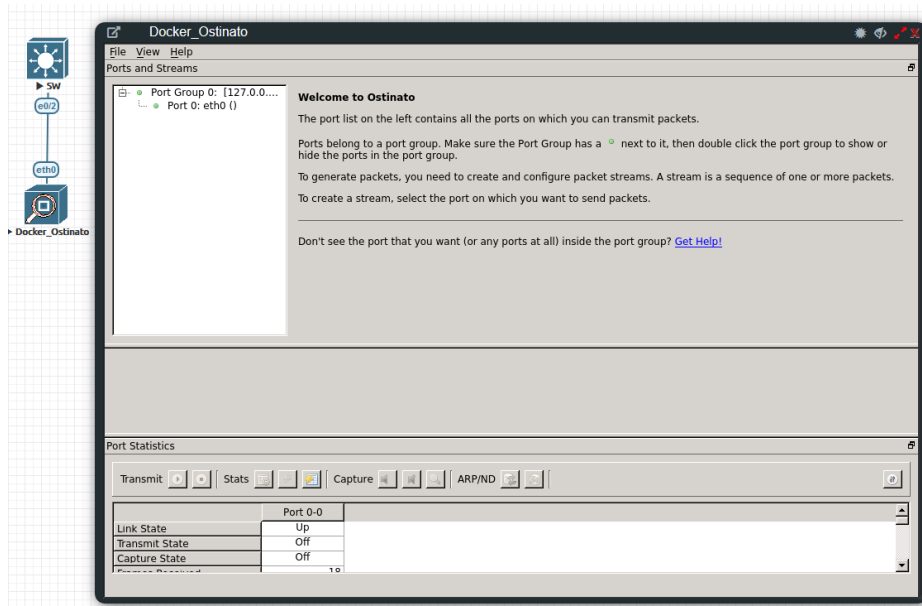

14.1.2 Docker DHCP IP address setup

EVE integrated Docker stations have two options for setting an IP address.

DHCP IP address option.

Step 1: Add the node to the topology and make sure the DHCP option is **enabled** under the edit node window. Refer to section 14.2 for the correct console type.

Step 2: Ensure the docker's DHCP request can reach a DHCP server either in your lab or externally through a Cloud Network like Cloud0.

Additional Settings

Console rdp	RDP Username	RDP Password
Docker Settings		
Ethernets 1	Enable DHCP on Eth0 <input checked="" type="checkbox"/>	Enable IPV6 <input type="checkbox"/>

14.1.3 Docker Static IP and MAC address setup

Step 1: Add the node to the topology and make sure the DHCP option is **disabled** under the edit node window Reference section 14.2 for the correct console type.

Step 2: On the left sidebar menu open Startup-config and use the example syntax below to set the ip for your Docker node. Make sure you are using the exact syntax for your static IP setup:

```
# Set ip address and Default route
ip addr add 10.100.100.103/24 dev eth0 || true
ip route add default via 10.100.100.1 || true

# Set DNS server
cat > /etc/resolv.conf << EOF
nameserver 8.8.8.8
EOF
```

Step 2.1 (Optional): On the left sidebar menu open Startup-config and use the example syntax below to set the custom MAC for your Docker node. Make sure you are using the exact syntax for your static MAC setup:

```
# Set ip address and Default route
ip link set dev eth0 address XX:XX:XX:XX:XX:XX || true
ip addr add 10.100.100.103/24 dev eth0 || true
ip route add default via 10.100.100.1 || true

# Set DNS server
cat > /etc/resolv.conf << EOF
nameserver 8.8.8.8
EOF
```

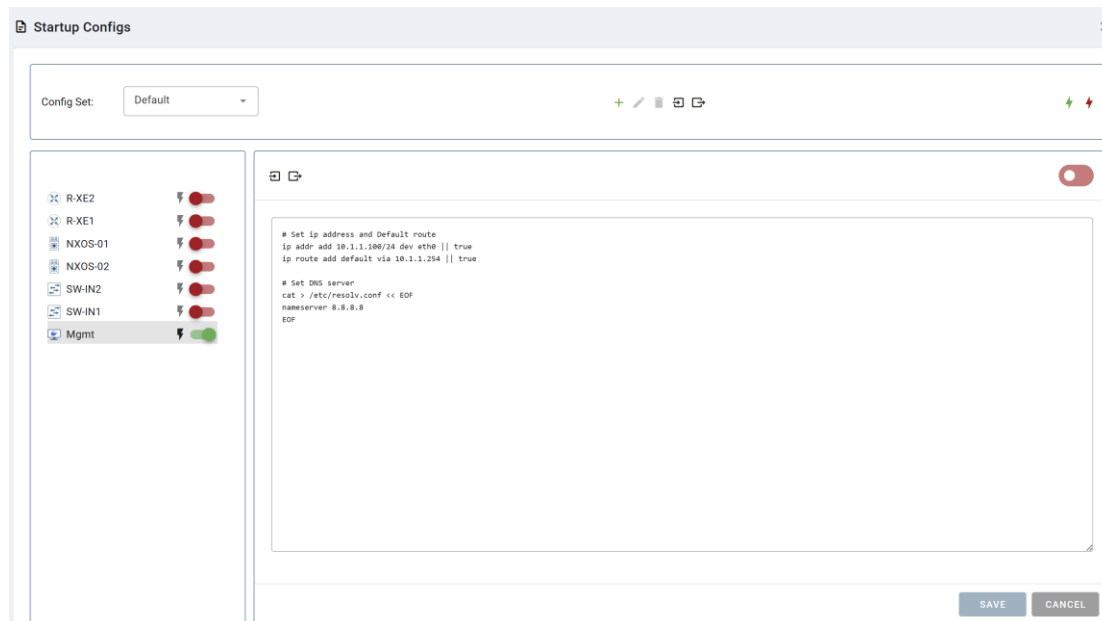

Step 3: Press the Save button below and switch the node to boot from the startup-config.

14.1.4 Docker multi-interfaces setup

Step 1: Add the node to the topology and make sure the DHCP option is **disabled** under the edit node window Reference section [14.2](#) for the correct console type.

Step 2: On the left sidebar menu open Startup-config and use the example syntax below to set the ip for your Docker node. Make sure you are using the exact syntax for your static IP setup. It is recommended to add static routes under interfaces to reach specific networks if required.

```
# Set ip address eth0
ip addr add 192.168.1.200/24 dev eth0 || true
ip route add default via 192.168.1.1 || true

# Set ip address eth1
ip addr add 172.16.1.201/24 dev eth1 || true
# Set static route for eth1
ip route add 10.100.100.0/24 via 172.16.1.1 dev eth1 || true

# Set ip address eth2
ip addr add 10.1.1.10/24 dev eth2 || true
# Set static route for eth2
ip route add 10.10.10.0/24 via 10.1.1.1 dev eth2 || true

# Set DNS server
cat > /etc/resolv.conf << EOF
nameserver 8.8.8.8
EOF
```

14.1.5 Docker server-gui custom WEB page

Step 1: Add the node to the topology and make sure the DHCP option is **disabled** under the edit node window Reference section [14.2](#) for the correct console type.

Step 2: On the left sidebar menu open Startup-config and use the example syntax below to set the ip and html page for your Docker node. Make sure you are using the exact syntax for your static IP setup and custom HTML values:

```
# Set ip address and Default route
ip addr add 10.100.12.100/24 dev eth0 || true
ip route add default via 10.100.12.10 || true

# Set DNS server
cat > /etc/resolv.conf << EOF
nameserver 8.8.8.8
EOF

# Create a Default web page
# Use 'EOF' do avoid variable from expanding

# Delete default index page
rm /var/www/html/index.html || true

# Create a Default web page
# Use 'EOF' do avoid variable from expanding
```

```

cat > /var/www/html/index.php << 'EOF'
<center>
<?php
echo gethostname();
?>
<hr>

<hr>

<?php
//whether ip is from share internet
if (!empty($_SERVER['HTTP_CLIENT_IP']))
{
    $ip_address = $_SERVER['HTTP_CLIENT_IP'];
}
//whether ip is from proxy
elseif (!empty($_SERVER['HTTP_X_FORWARDED_FOR']))
{
    $ip_address = $_SERVER['HTTP_X_FORWARDED_FOR'];
}
//whether ip is from remote address
else
{
    $ip_address = $_SERVER['REMOTE_ADDR'];
}
echo 'Client Address:'. $ip_address;
?>
</center>
EOF

```

Step 3: Press the Save button below and switch the node to boot from the startup-config.

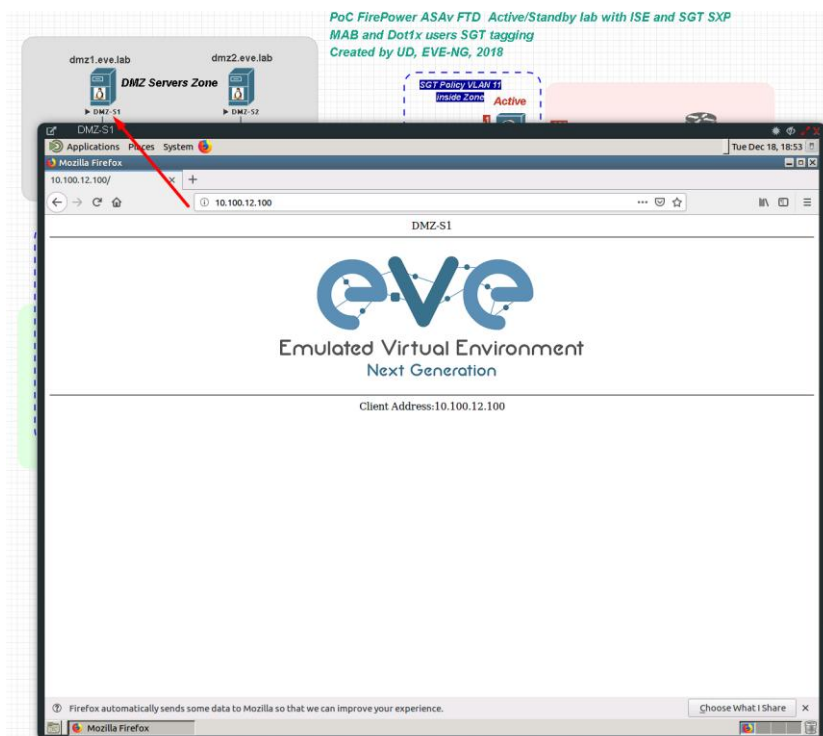

14.1.6 Docker server-gui SSL WEB page

Following previous chapter, you can enable on the server-gui node SSL/HTTPS certificate.

Step 1: Open Applications/System Tools/MATE Terminal

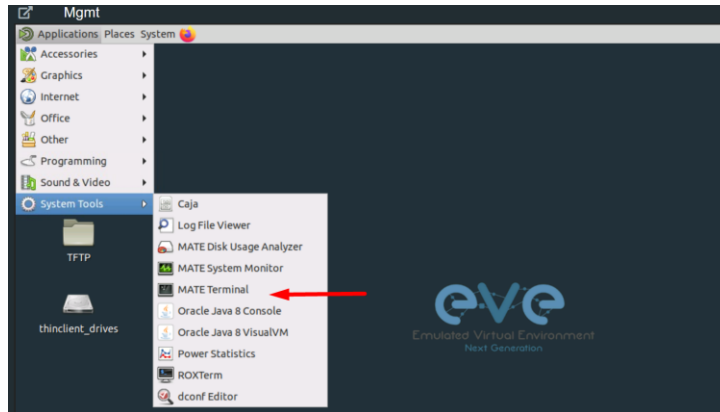

Step 2: Create SSL certificate, single line command, and fill up requested details.

```
openssl req -x509 -nodes -days 365 -newkey rsa:2048 -keyout
/etc/ssl/private/apache-selfsigned.key -out /etc/ssl/certs/apache-
selfsigned.crt
```

Step 3: Enable SSL certificate for web page.

```
/usr/sbin/a2enmod ssl
/usr/sbin/a2ensite default-ssl
```

Step 4: Restart apache2 service

```
sv stop apache2
sv start apache2
```

14.1.7 Docker server-gui SSH root access activation

Step 1. Use Mgmt_Server MATE Terminal, type:

```
vi /etc/ssh/sshd_config
```

Step 2. Navigate and find PermitRootLogin and uncomment. (delete #). Locate cursor under # sign and press "x". Then press ESC and type: ".wq", Enter

```
#LoginGraceTime 2m
PermitRootLogin yes
#StrictModes yes
#MaxAuthTries 6
#MaxSessions 10
```

Step 3. Restart SSH service

```
/etc/init.d/ssh restart
```

14.2 Docker Consoles

To set consoles for EVE Docker stations, right click on node and click Edit. Set the required console type

Edit Node

Docker Station	Console type
eve-gui-server (napalm, ansible)	RDP/Telnet
eve-chrome (optional)	RDP
eve-wireshark	RDP
eve-firefox	RDP
eve-ostinato (optional)	RDP

14.3 Docker cli root access

All EVE docker stations have the following configured CLI root account.

Username: root

Password: eve

! NOTE: The root login for SSH can be commented in sshd file. Use vi to edit and remove comment “#” for PermitRootLogin

```
vi /etc/ssh/sshd_config
PermitRootLogin yes
```

Regular user (root user) SSH access to EVE Docker:

Username: nobody

Password: eve

14.4 Dockers re-install/update

To install or fix docker stations in the EVE Pro issue the following commands from the CLI of EVE.

When dockers are properly installed, your EVE CLI command `dc images` output must show:

```
root@eve-ng:~# dc images
REPOSITORY          TAG          IMAGE ID      skt      CREATED      50 GB      SIZE
eve-desktop         latest      ca1333621bd7      12 hours ago
eve-gui-server      latest      9db19c879a17      controller 2 days ago  USB 2.0    3.84GB
eve-firefox         latest      0266d108a1bb      7 weeks ago
eve-wireshark       latest      82a009773e89      kadapter   7 weeks ago  VM Manager 1.56GB
root@eve-ng:~#
```

If you still see some docker line with <none>

```
root@eve-ng:~# dc images
REPOSITORY          TAG          IMAGE ID      CREATED      SIZE
<none>              <none>      cc286e6ac274  16 seconds ago  1.87GB
eve-gui-server      latest      f3aa6e0e9a56  3 minutes ago  3.04GB
eve-wireshark       latest      638ed7cf5b80  12 minutes ago  887MB
eve-firefox         latest      259293d73b07  13 minutes ago  1.49GB
eve-desktop         latest      78e9c2e618a5  15 minutes ago  2.79GB
```

please use reinstall dockers command:

```
apt install --reinstall eve-ng-dockers
```

Reference for Dockers reinstall and upgrade: <http://www.eve-ng.net/documentation/eve-ng-upgrade>

14.5 Extra docker packages

NOTE: Not included in the default EVE Pro installation. This can take some time depending on your Internet connection and disk speed.

Chromium Linux http, to install issue CLI command:

```
apt update
apt install eve-ng-chrome
```

Ostinato docker, to install issue CLI command:

```
apt update
apt install eve-ng-ostinato
```

Docker-in-docker (DinD) docker. This docker is dedicated for complex docker stacks. Refer section: **14.6.2**. To install issue CLI command:

```
apt update
apt install eve-ng-dind
```

To verify Installed dockers, issue CLI command

```
dc images
root@eve-ng:~# dc images
REPOSITORY          TAG          IMAGE ID          CREATED          SIZE
eve-dind             latest      6e067b53b145     3 days ago      747MB
eve-gui-server       latest      0c764bb836f9     2 months ago    3.69GB
eve-wireshark        latest      413aae02d43d     4 months ago    1.62GB
eve-firefox          latest      8882ac260c1f     4 months ago    2.15GB
eve-ostinato         latest      63497fd2da4d     4 months ago    1.79GB
eve-desktop          latest      b041a187ded9     4 months ago    3GB
dockergui-rdp        latest      be03f3b46439     4 months ago    1.29GB
root@eve-ng:~#
```

14.6 Third parties dockers

Starting EVE-NG Pro version 2.0.6-52, the third party dockers can be installed on the EVE. However, some limitation still exists. You are free to evaluate by yourself if a specific one is working.

Two main categories of dockers require each a specific method for EVE integration:

- ❖ Simple Docker
- ❖ Docker's Stack

14.6.1 Simple docker installation

Simple docker is the classic docker running in a standalone mode. You could find large choice of docker images on <https://hub.docker.com> or create the Docker by yourself.

Complete guide about dockers can be found on <https://docs.docker.com/>

Note: Internet access is a must. For simple docker, you only have to use:

```
dc pull <dockername>
```

Note: "dc" is EVE-NG alias for docker -H tcp://127.0.0.1:4243 which simplify docker operations in the EVE.

Once your new docker is pulled, you are able to use it in EVE-NG topologies. EVE-NG will start it using correct parameters automatically.

Example: SSH to your EVE. Install adosztal AAA docker:

```
root@eve-v6-master:~# dc pull adosztal/aaa
```

```
root@eve-v6-master:~# dc images
REPOSITORY      TAG      IMAGE ID      CREATED      SIZE
registry        2        9363667f8aec  4 weeks ago  25.4MB
eve-ostinato    latest   5e74596c24b0  5 weeks ago  4.22GB
eve-gui-server  latest   d819486ab729  5 weeks ago  7.07GB
eve-desktop     latest   aaab99abf9b9  5 weeks ago  6.88GB
eve-firefox     latest   01c3151ae759  5 weeks ago  4.69GB
eve-wireshark   latest   030d66992f3d  7 weeks ago  4.24GB
adosztal/aaa    latest   6e12e4096083  3 years ago  314MB
root@eve-v6-master:~#
```

New docker use: Open a new lab, add docker and select adosztal/aaa with console in tenet mode.

14.6.2 Docker stack installation

Docker's Stack is a complex structure of multi intercommunicating dockers. For example, a Web service docker is using another Database Docker service.

To avoid involve EVE host internal process and network, the new add-on docker is provided: "eve-dind". This add-on is a dedicated docker container allowing to build complex stack. The classic method is based on docker-compose.

The example below illustrates how to build complex docker LibreNMS, Network Management System.

Note: Internet access is a must. SSH to your EVE as root.

Sample:

Step 1: On eve cli, type:

```
apt update
apt install eve-ng-dind
```

Note: install eve-ng-dind add-on docker and is required only once.

Step 2: Create a new lab

Step 3: Add on the lab:

- a. NAT network
- b. Docker eve-dind (set console to 'telnet' and enable dhcp)

Step 4: Connect docker to NAT network

Step 5: Start Docker

Step 6: Open Docker Console

Step 7: Type in console:

```
git clone https://github.com/librenms/docker.git librenms-src
cp -r librenms-src/examples/compose librenms
rm -fr librenms-src
cd librenms
docker-compose up -d
```

Commit your created docker with new name.

Step 8: Open a cli access to your [EVE server](#)

Step 9: Type within the EVE cli:

Find your current running container ID using eve-dind image

```
dc ps -a
```

```
root@eve-ng:~# dc ps -a
CONTAINER ID   IMAGE                                COMMAND                  CREATED          STATUS
PORTS         NAMES
b96743436dd8  eve-dind:latest                    "dockerd-entrypoint.â€¦" About a minute ago Up About a minute
7d83609410aa  eve-gui-server:latest              "/sbin/my_init"        10 hours ago    Up 10 hours
13ee6dc804ae  eve-gui-server:latest              "/sbin/my_init"        8 days ago      Exited (0) 16 hours ago
```

Step 10: **IMPORTANT:** On the Lab UI stop docker. Do not wipe, but stop.

Step 11: Commit your created docker with custom name.

```
dc commit <containerid> eve-librenms
```

Step 12: On LAB UI: Stop all nodes, Close Lab, Delete Lab

Note, when you add newly created docker in lab, use vendor advised settings, x4 CPU and 8GB Ram for librenms docker. Console: Telnet. Graphic Interface https.

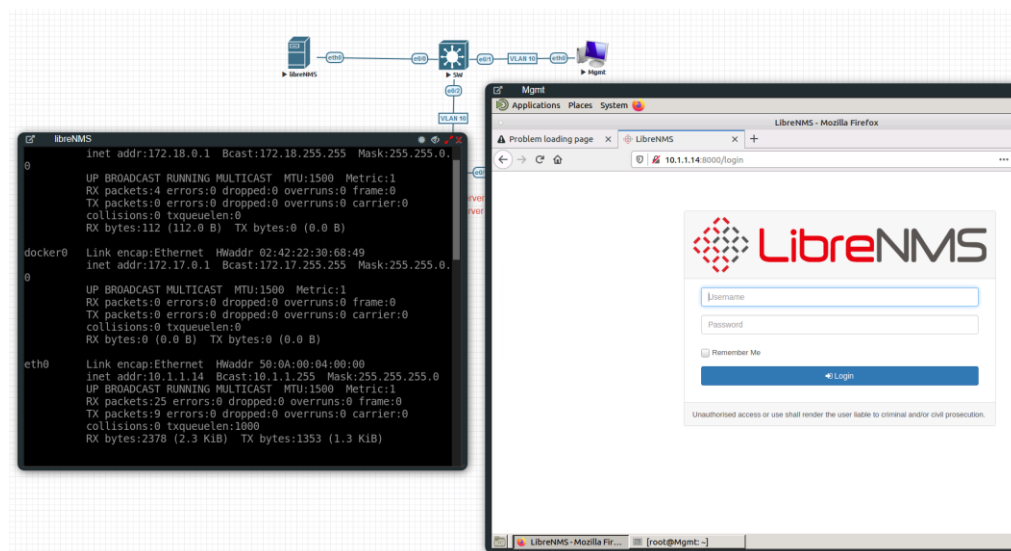

14.7 Vendor Dockers' installation (XRD, vEOS, SR Linux)

Quick build guides — Docker images for EVE-NG (Advanced)

Short procedures to build or import Docker images for **Cisco XRd**, **Arista cEOS**, and **Nokia SR Linux** on an EVE-NG server. Run the commands on the EVE-NG host (or where Docker is used by EVE-NG). Adjust version numbers if you use different releases.

14.7.1 Cisco XRd (control plane container)

Template in EVE-NG: XRD (Cisco XRD Control plane docker)

1. **Obtain** the XRd control plane container image via the **official Cisco channel** (Cisco download portal or your Cisco representative). Look for the **xrd-control-plane-container** package for your architecture (e.g. x86).
2. **Copy** the archive to the EVE-NG server (e.g. `/root/` or `/opt/unetlab/tmp/`).
3. **Extract and load** (adjust the `.tgz` filename to your version, e.g. `x86.25.4.1` → your build):

```
tar -zxvf xrd-control-plane-container-x86.25.4.1.tgz
docker load -i xrd-control-plane-container-x64.dockerv1.tgz
```

4. **Tag** the image so EVE-NG can use it with the XRd template (image name must match what the template expects, e.g. `xrd-control-plane:25.4.1`):

```
docker tag ios-xr/xrd-control-plane:25.4.1 xrd-control-
plane:25.4.1
```

5. In EVE-NG, add a node with template **XRd** and choose image **xrd-control-plane:25.4.1** (or the version you tagged).

Note: The XRd template uses `prep_xrd.sh` and `init_xrd.sh`; ensure those scripts are present under `/opt/unetlab/config_scripts/` on the EVE-NG server.

14.7.2 Arista cEOS (Lab)

Template in EVE-NG: cEOS (Arista cEOS)

1. **Create an account** on the Arista website if you do not have one. The **cEOS Lab** images are **freely downloadable** from Arista (e.g. from the Arista support / software download portal). Download the image for your architecture (e.g. `cEOS64-lab-4.35.1F.tar.xz`).
2. **Copy** the `.tar.xz` file to the EVE-NG server.
3. **Import** the archive as a Docker image and **tag** it (use the exact tag format `ceos-lab:X.Y.Zf` so it appears in the template's image list):

```
docker import cEOS64-lab-4.35.1F.tar.xz ceos-lab:4.35.1f
```

4. In EVE-NG, add a node with template **cEOS** and choose image **ceos-lab:4.35.1f** (or the version you imported).

Note: The cEOS template uses `config_ceos.py` and expects the image to run with the default `dock_cmd/dock_args` from the template (systemd, CEOS env vars). No extra prep/init scripts are required for a basic setup.

14.7.3 Nokia SR Linux

Template in EVE-NG: SRLinux IRXD2L, SRLinux IRXD3, SRLinux IRXD3L (and variants)

1. **Pull** the official Nokia SR Linux image from GitHub Container Registry:

```
docker pull ghcr.io/nokia/srlinux
```

2. **Tag** the image for each EVE-NG template you want to use. Template names and image names typically match:

```
docker tag ghcr.io/nokia/srlinux srlinux-ixr-d2l
docker tag ghcr.io/nokia/srlinux srlinux-ixr-d3
docker tag ghcr.io/nokia/srlinux srlinux-ixr-d3l
```

3. In EVE-NG, add a node and choose one of the **SR Linux** templates (e.g. **SRLinux IRXD2L**), then select the matching image (e.g. **srlinux-ixr-d2l**). Same image can be used for all three templates; the template defines interfaces and startup behaviour.

Note: SR Linux templates use `config_srlinux.py`; the **SRLinux IRXD2L** template uses `init_srlinux-ixr-d2l.sh`. Ensure those scripts exist under `/opt/unetlab/config_scripts/`. For **SRLinux IRXD3 / SRLinux IRXD3L**, the corresponding init scripts (`init_srlinux-ixr-d3.sh`, `init_srlinux-ixr-d3l.sh`) must be present if the template references them.

14.8 Customize docker image with your own changes.

Step 1. Connect your existing docker node to the internet

Sometimes you may have your own packages to be installed on the docker and kept for future labs. For this connect your docker to the Internet. It can be achieved connecting docker to Management Cloud0 or NAT cloud. **Example below**, Sever-gui docker is connected to Cloud NAT.

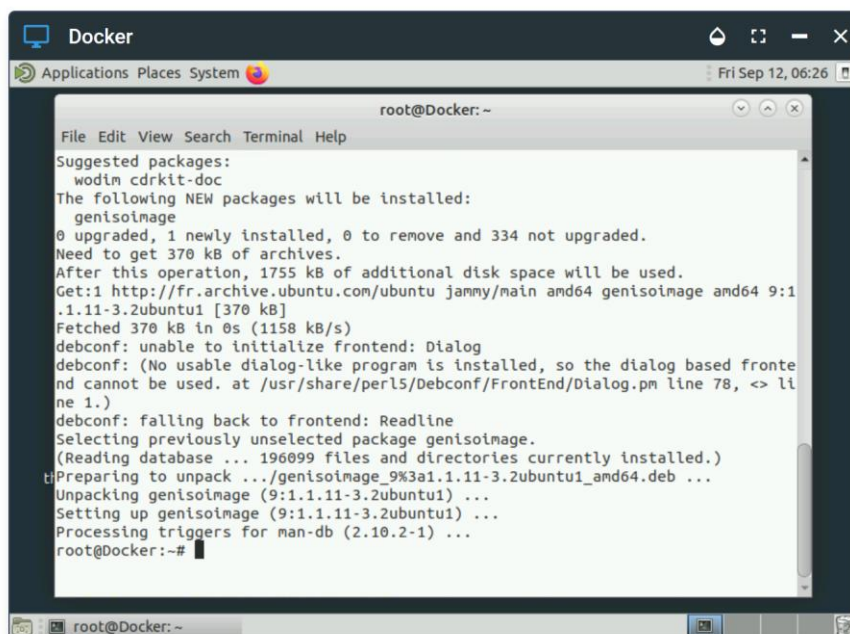

Step 2. Make your installs, packages. Example:

In the screen above I did install `genisoimage` package

```
apt install genisoimage
```

Step 3. Obtain your RUNNING docker container ID:

From EVE CLI issue command:

```
dc ps
```

```
root@eve-ng:~# dc ps
CONTAINER ID        IMAGE               COMMAND             CREATED             STATUS              PORTS
NAMES
0d4b3f8c314c      eve-gui-server:latest  "/sbin/my_init"    33 hours ago       Up 2 minutes
b37bf9cb-0c6f-4bcb-b838-10d877ecce78-10-5  P...
root@eve-ng:~# ^C
root@eve-ng:~#
In the screen above I did install eve-gui-server package
```

Step 4. Commit your prepared docker image with new name. example below I called it eve-geniso

dc container commit <containerid> <newimagename>

```
dc container commit 0d4b3f8c314c eve-geniso
```

Step 5 check if new Docker image is created

```
dc images
```

```
root@eve-ng:~# dc images
REPOSITORY          TAG                IMAGE ID           CREATED           SIZE
eve-geniso          latest            e6dd56c3b26c     4 seconds ago   3.19GB
eve-kali            latest            d1fda568e8a0     3 weeks ago     4.77GB
eve-nso            latest            f2a7a3d6a423     8 weeks ago     3.95GB
eve-ostinato       latest            e89cad6b1813     2 months ago    1.34GB
eve-gui-server     latest            a13cb401c8dd     3 months ago    3.11GB
eve-firefox        latest            8900664e9f3b     4 months ago    1.49GB
eve-chrome          latest            51fd92216b99     4 months ago    1.61GB
eve-wireshark      latest            0c49fe2dc6bb     7 months ago    888MB
eve-desktop        latest            c285d1ec833c     7 months ago    2.39GB
dockergui-rdp      latest            a65b62fa69b6     9 months ago    553MB
phusion/baseimage  0.9.22           877509368a8d     2 years ago     225MB
root@eve-ng:~#
```

Step 6. Optional, If you want to keep this image and later load in other EVE installs, then you must create exportable .tar image.

```
dc image save -o /root/mysuperimage.tar <image name>
```

Step 7 Optional, upload your .tar file in new EVE root, and install it in Dockers location.

```
dc image load -i /root/mysuperimage.tar
```

14.9 Custom docker name tags

For different docker containers you may need to set different rights for your custom docker development. EVE-NG Supports 3 levels of dockers' privileges. To achieve it, rename your deployed docker image.

Standard Docker Name Tag:

```
dc tag <yourdockername>:latest <yourdockername>:latest
```

Privileged Docker Tag:

```
dc tag <yourdockername>:latest <yourdockername>:privileged
```

or

```
dc tag <yourdockername>:latest <yourdockername>-privileged:latest
```

DinD Docker Name Tag:

```
dc tag <yourdockername>:latest <yourdockername-dind:latest
```

Example to create gui-server docker in privileged mode:

```
dc tag eve-gui-server:latest eve-gui-server-privileged:latest
```

14.10 Delete docker image from EVE

Step 1. From EVE CLI issue command to check docker ID to be removed.

```
dc images
```

```
root@eve-ng:~# dc images
REPOSITORY          TAG          IMAGE ID          CREATED          SIZE
eve-geniso          latest      e6dd56c3b26c    4 seconds ago   3.19GB
eve-kali            latest      d1fda568e8a0    3 weeks ago     4.77GB
eve-nso             latest      f2a7a3d6a423    8 weeks ago     3.95GB
eve-ostinato        latest      e89cad6b1813    2 months ago    1.34GB
eve-gui-server      latest      a13cb401c8dd    3 months ago    3.11GB
eve-firefox         latest      8900664e9f3b    4 months ago    1.49GB
```

Step 2. Use command: `dc rmi -f <id of docker image>`.

```
dc rmi -f e6dd56c3b26c
```

Step 3. Check with `dc images` if docker is removed.

Step 4. Finish removal with `apt remove --purge eve-ng-chrome`, where eve-ng-chrome is your docker repository name.

15 EVE Cluster System

The EVE-NG cluster refers to a group of EVE-NG nodes working together as a single entity to provide users with better scalability and availability.

The EVE-NG cluster model is designed to work as a one + many systems, the EVE-NG management server is acting as "Master" node, EVE-NG installations as "Satellite" can be members of this cluster.

One "Master" EVE-NG can have several satellites joined into its cluster but each satellite can only be joined to one Cluster/Master.

Any existing EVE-NG Pro installation is already a EVE-NG "Master", cluster members will need to be installed as "satellite" and can then easily be joined.

15.1 EVE Cluster Licensing

EVE-NG Cluster system only the Master node is required to have a license. It is classic EVE Professional or LC/Corporate license.

Satellite nodes has special light EVE-NG Agent installation described below in Chapters: 15.5, 15.6 and 15.8. The Satellite nodes need not special EVE-NG License

One "Master" EVE-NG can have several satellites joined into its cluster but each satellite can only be joined to one Cluster/Master.

15.2 EVE Cluster design models

15.2.1 Bare metal servers cluster

Design 1 EVE-NG Cluster Bare HW servers, recommended

EVE Cluster 208 vCPU, 896GB RAM, 16TB SSD. Cluster members can be different HW configuration. The 1GB LAN connection or better is required

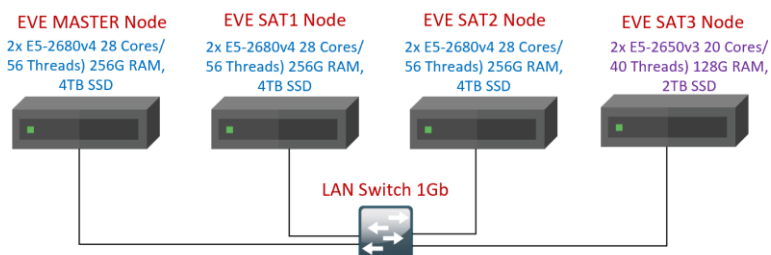

15.2.2 ESXi Virtual Machines cluster

Design 2 EVE-NG Cluster VM Ware ESXi Virtual Machines

EVE Virtual ESXi Cluster 112 vCPU, 384GB RAM, 8TB SSD. Cluster members can be different VM configuration and located on same or different ESXi servers

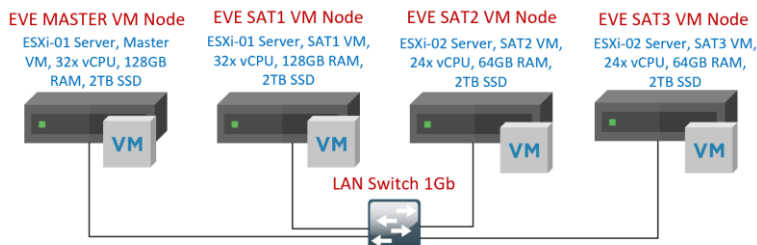

15.2.3 Hybrid cluster

Design 3 Hybrid EVE-NG Cluster Bare metal and VM Ware ESXi Virtual Machines

EVE Hybrid Bare HW and ESXi Cluster 120 vCPU, 384GB RAM, 6TB SSD. Cluster members can be different VM configuration and located on same or different ESXi servers

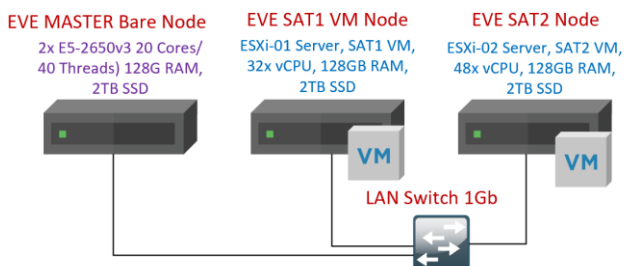

15.2.4 VM Ware workstation light cluster

Design 4 Light EVE-NG Cluster Desktop PCs and Wifi Laptop with VM Ware workstation and Virtual Machines

Light EVE Cluster with Desktop PCs and Laptop Wifi.

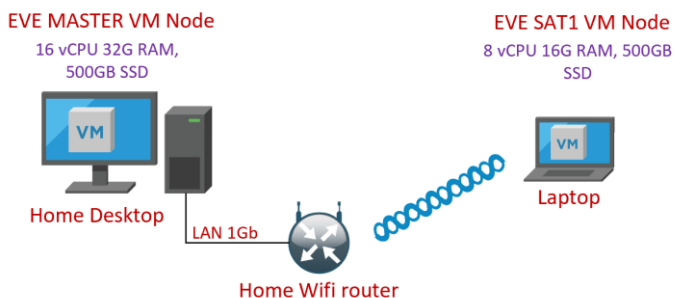

15.2.5 Google Cloud cluster

NOTE: Your EVE Master must have Public IP address to join GCP satellite

Design 5 EVE-NG Cluster Desktop PCs VM Ware workstation VM and Google Cloud VMs

High speed internet is required

EVE MASTER VM Node

16 vCPU 32G RAM,
500GB SSD



Home Desktop

EVE SAT1 VM Node on GCP

16 vCPU 32G RAM,
500GB SSD



LAN 1Gb
Home Wifi router



15.3 EVE Cluster pre-requisites

15.3.1 Firewall rules between Master and Satellite nodes

Node	Protocol	Port	Direction	Source	Destination
MASTER	TCP	22	ingress and egress	MASTER node IP	SATELLITE nodes IPs
MASTER	UDP	60569	ingress and egress	MASTER node IP	SATELLITE nodes IPs
SATELLITE	TCP	22	ingress and egress	SATELLITE node IP	MASTER Node IP
SATELLITE	UDP	60569	ingress and egress	SATELLITE node IP	MASTER Node IP

15.3.2 EVE Cluster interface MTU settings

IMPORTANT: The management interface MTU for all EVE-NG Cluster members MUST have the same value. The default ethernet MTU value is 1500.

15.3.3 EVE Cluster internal management network

An EVE Cluster for internal management is using network **172.29.130.0/24**. Please avoid use it in your network.

15.3.4 EVE Cluster Member's hardware requirements

Any suitable Hardware or virtual device. Please refer Chapter 2

15.3.5 NTP Synchronization requirements

It is mandatory that during install your cluster Satellite member have same time NTP synchronization as the Master server.

15.4 EVE Cluster MASTER Node Installation

- ⚠ **Mandatory Prerequisites: Internet must be reachable and DNS must resolve from your EVE Server. EVE ISO installation requires internet access and DNS to get updates and install the latest EVE-PRO version from the EVE-NG repository, to check it, do a named ping, for example ping www.google.com**
- ⚠ **It is mandatory that during install your cluster Satellite member have same time NTP synchronization as the Master server.**

Any existing EVE-NG Pro installation is already a EVE-NG "Master", cluster members will need to be installed as "Satellite" and then can be easily joined. Please refer Chapter 3

15.5 ESXi EVE Satellite VM installation

Download EVE-NG Professional Full ISO distribution image:
<https://www.eve-ng.net/index.php/download/>

15.5.1 EVE-NG Satellite ESXi VM Setup and Settings

Step 1: Upload Full EVE ISO image to the ESXi store.

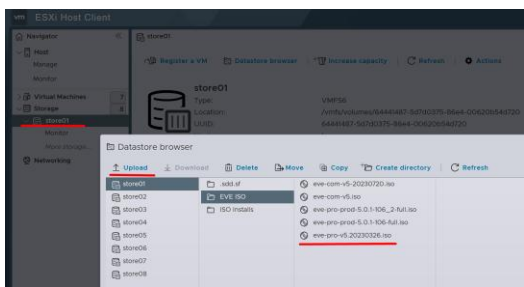

The screenshot shows the ESXi Datastore browser interface. The 'Datastore browser' pane is active, displaying a list of files in the 'store01' datastore. The file 'eve-pro-6.20230226.iso' is highlighted in red, indicating it has been successfully uploaded. Other files in the list include 'eve-pro-5.1-106_2-All.iso' and 'eve-pro-5.1-106-All.iso'.

Step 2: Create NEW VM

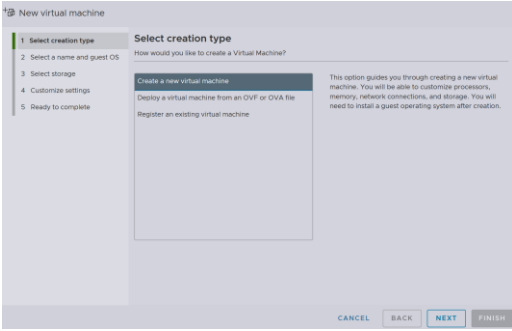

The screenshot shows the 'New virtual machine' wizard. The 'Select creation type' step is active, with the 'Create a new virtual machine' option selected. The 'Deploy a virtual machine from an OVF or OVA file' and 'Register an existing virtual machine' options are also visible but not selected. The 'NEXT' button is highlighted.

Step 3: Enter the name for your EVE-PRO-SAT VM and select Guest Operating system Linux and version: **Ubuntu 64-bit**

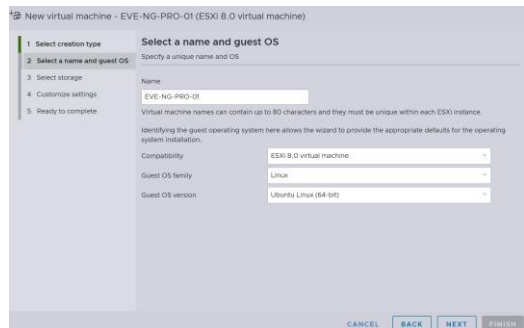

Step 4: Select Location where your EVE VM will be stored in HDD.

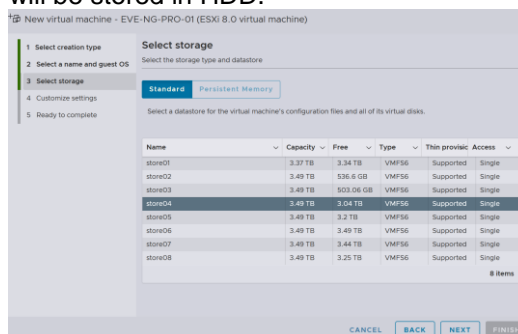

Step 5: **⚠ IMPORTANT** OPTION for ESXi 6.7.x or later.

Set Processors “Number of processors” and Set “Cores per Socket”. If your server has dual CPU, then Cores per socket will be divided by 2. Example below, shows dual CPU Server VM setup with 48 CPU with 24 cores per socket (2).

Set **Expose hardware assisted virtualization to the guest OS to ON (checked)** and set **Expose IOMMU to the guest OS to ON (checked)**

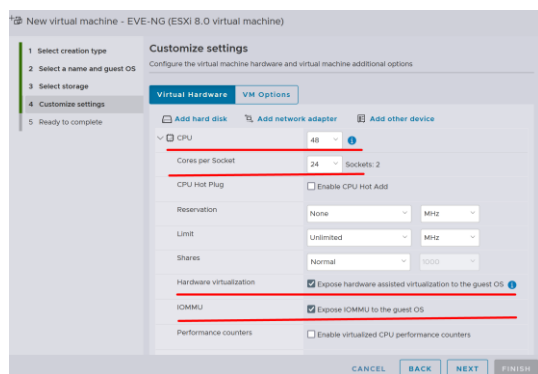

Step 6: Assign desirable RAM for your EVE

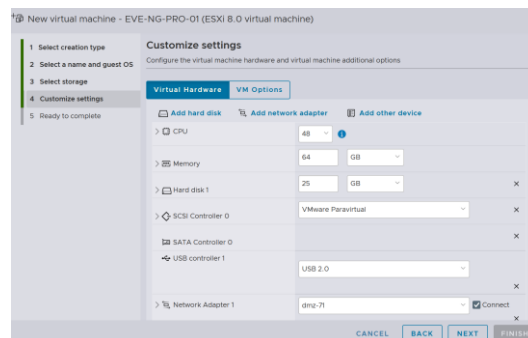

Step 7: Set the size of HDD for your new EVE VM. It is recommended to set “Thick Provisioned eagerly provisioned”. Server

Step 8: Set your Management network. Adapter type VMXNET3

EVE HDD is recommended to set at least 500Gb

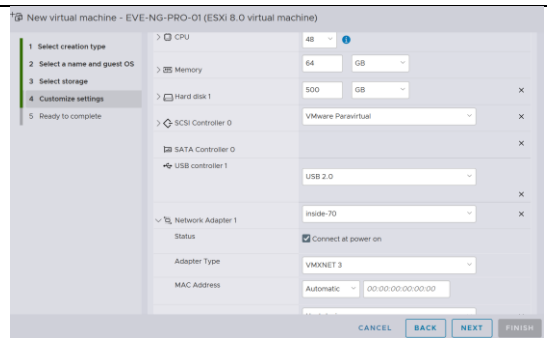
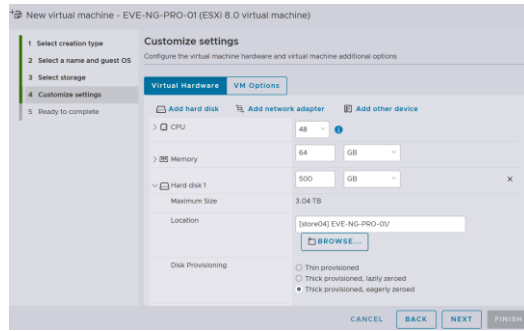

Step 9: Set DVD drive to “Datastore ISO File” and browse your uploaded Full-EVE-PRO.iso (ISO name can vary). Make sure that Status is checked ON, “Connect at power on”

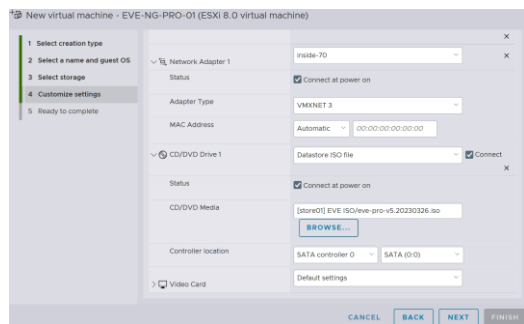

Step 10: Set DVD drive to “Datastore ISO File” and browse your uploaded Full-EVE-PRO.iso (EVE ISO name can vary). Make sure that Status is checked ON, “Connect at power on” Hit the “Finish”

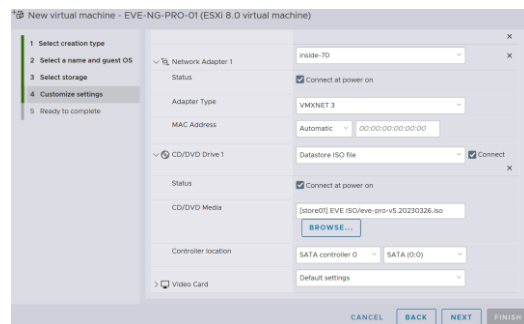

Step 11: IMPORTANT If you are using ESX 8.0 or later, select the Edit your VM and switch to “VM Options”. Firmware *EFI Boot*.

Follow to “Boot Options” and **de-select (uncheck) “Whether or not to enable UEFI secure boot for this VM”**

Step 12: Start VM and follow by 15.6.1.1

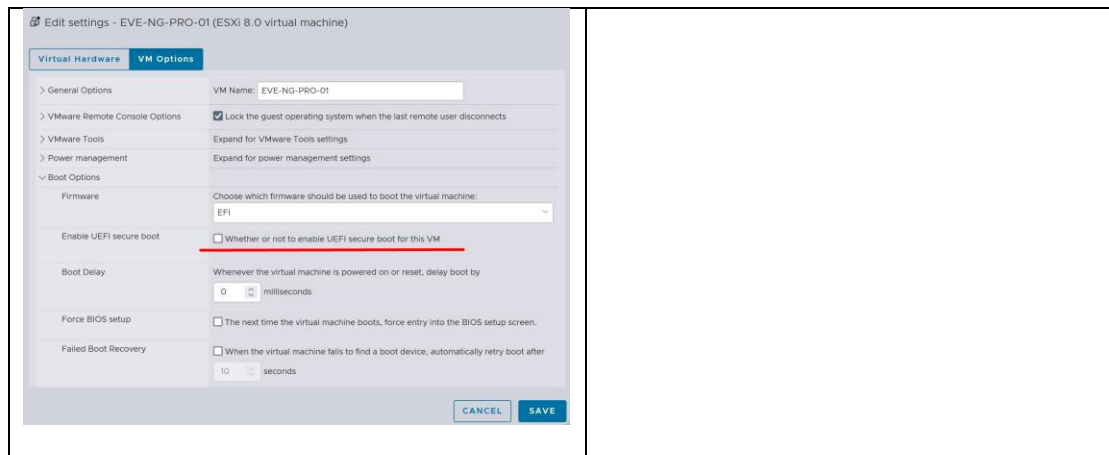

15.6 Proxmox VE

15.6.1 Proxmox VE EVE VM installation using ISO image

Download EVE-NG Professional Full ISO distribution image:

<https://www.eve-ng.net/index.php/download/>

15.6.1.1 EVE-NG VM Setup and Settings

<p>Step 1: Upload EVE ISO image to the Proxmox VE store.</p>	<p>Step 2: Create NEW VM, and set the name for your VM. Following by Next.</p>
---	---

<p>Step 3: OS tab. Select storage and ISO image. Following by Next.</p>	<p>Step 4: System tab. Check the Graphic Card (Default) and Machine (i440fx) is selected. Select BIOS: OVMF (UEFI) for installation as well. Check option Add EFI Disk and select your preferred HDD storage for it. Uncheck option Pre-</p>
--	---

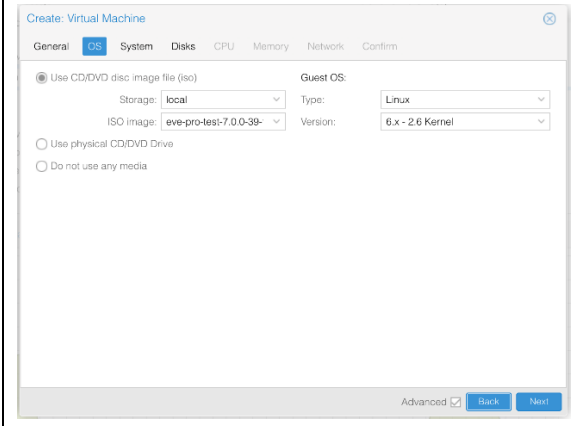

**Enrolled keys. Qemu Agent: Checked.
Add TPM: Unchecked. Following by Next.**

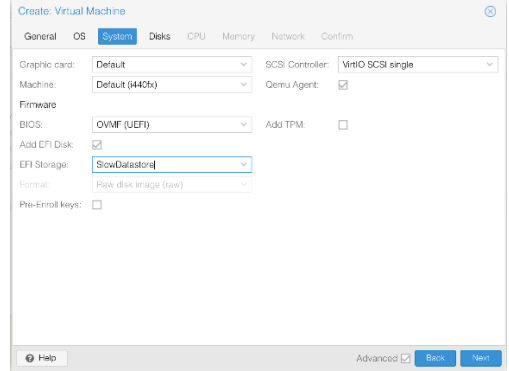

Step 5: Disks tab. Select Bus/Device: VirtIO Block. Select the storage where your EVE VM HDD will be located. Select the size of your EVE VM. Recommended is to select 200GB or more. Following by Next.

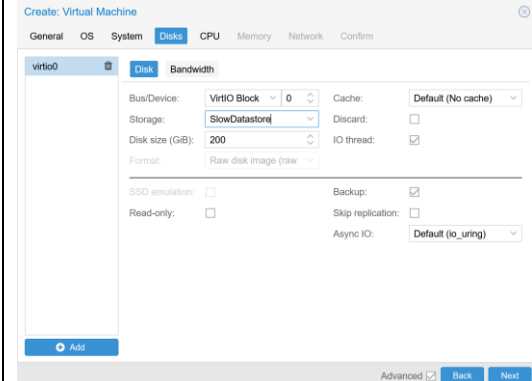

Step 6: CPU tab. Select the Sockets your Proxmox VE server have and select the cores per socket. In the example below is 1x socket with 32 cores per socket. **IMPORTANT: Your Proxmox VE CPU must support nested virtualization. Select Type: **Host**. Host will read all flags from your HW CPU and will use it for VM. Following by Next.**

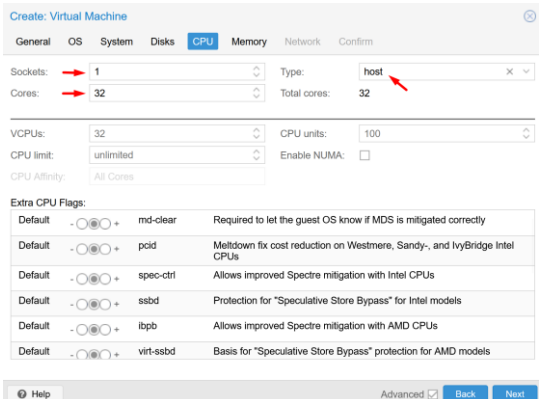

Default	Flags	Description
Default	md-clear	Required to let the guest OS know if MDS is mitigated correctly
Default	pcid	Meltdown fix cost reduction on Westmere, Sandy-, and IvyBridge Intel CPUs
Default	spec-ctrl	Allows improved Spectre mitigation with Intel CPUs
Default	ssbd	Protection for "Speculative Store Bypass" for Intel models
Default	ibpb	Allows improved Spectre mitigation with AMD CPUs
Default	virt-ssbd	Basis for "Speculative Store Bypass" protection for AMD models

Step 7: Memory tab. Set the size of Memory in MB. Following by Next.

Step 8: Network tab. Set your Management interface network. Following by Next.

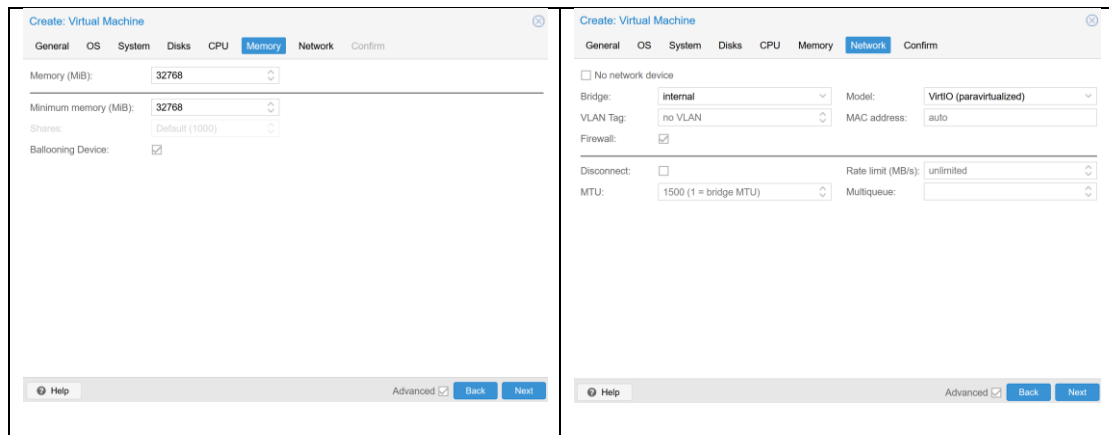

Step 9: Confirm tab. Check your VM settings. Following by Finish

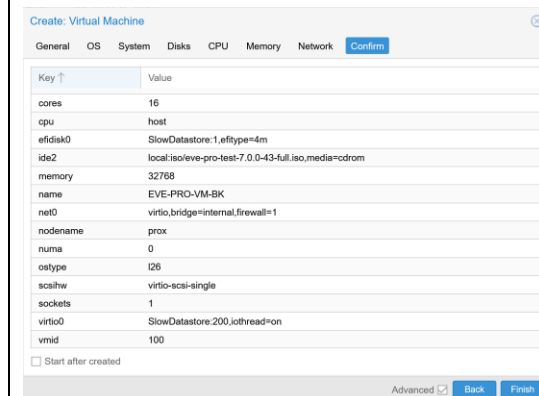

Step 10: Start VM and follow by 3.4

15.6.1.2 EVE-NG Satellite VM Installation steps

Satellite EVE VM Installation from ISO has 3 Phases

Phase 1 (Ubuntu installation)

Step 1: Power ON EVE VM. Chose Install EVE-NG Satellite and confirm with Enter.



Step 2: Select English language. Confirm with Enter.

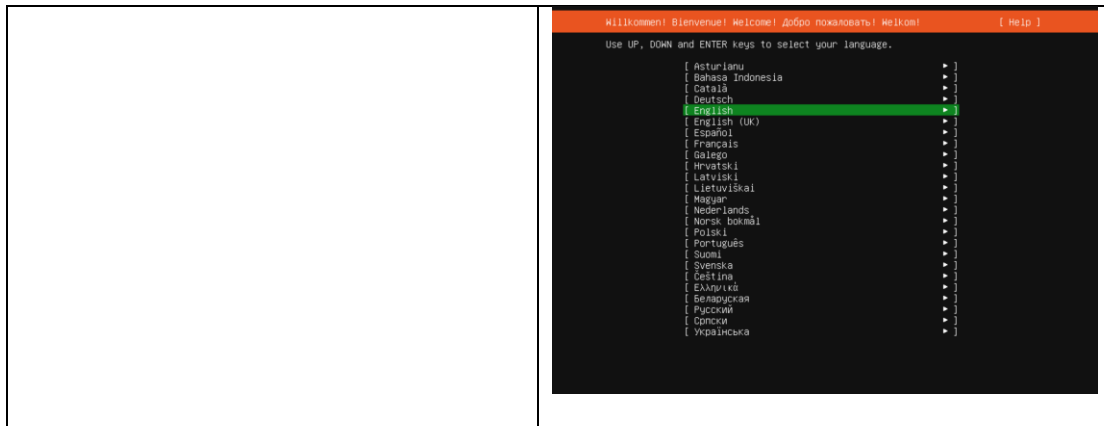

Step 3: Make sure if English US keyboard is selected and confirm with Enter.

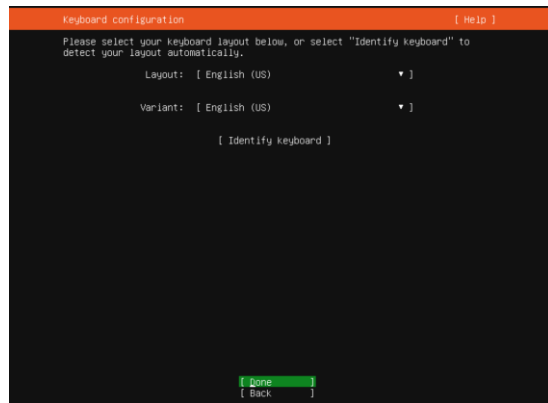

EVE VM Installation Phase 2 (EVE-NG installation)

Step 5: Please wait, the EVE-NG installation **Phase 2** will start automatically.

Do NOT login in this stage!

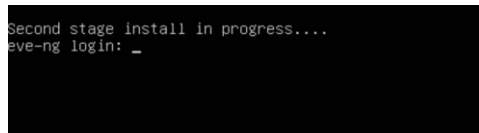

Step 6. After installation EVE VM will **auto reboot** and EVE login screen will appear, login in CLI with **root/eve** and follow installation Phase 3

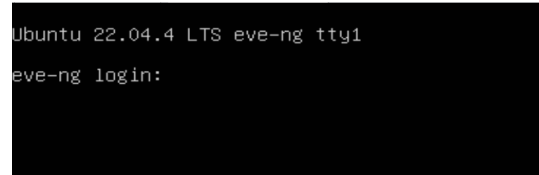

EVE VM Installation Phase 3 (Management IP setup and updates)

Step 7: Setup EVEs Management IP address. A Static IP address setup is preferred.

Step 8: **Internet and DNS reachability is a MUST**

<p>Follow steps in section: 3.8.1 for static IP, 3.8.2 for DHCP IP</p>	<p>After your EVE is rebooted, Login to EVE CLI and type:</p> <pre>apt update apt upgrade</pre> <p>If required, follow steps in section: 5.1, 5.2</p>
--	--

NOTE: To verify your EVE Satellite server installation type “dpkg -l eve-agent” it should display latest EVE Agent/Satellite version:

```
root@eve-sat01:~# dpkg -l eve-agent
Desired=Unknown/Install/Remove/Purge/Hold
|          Status=Not/Inst/Conf-files/Unpacked/halF-conf/Half-inst/trig-
aWait/Trig-pend
|/ Err?=(none)/Reinst-required (Status,Err: uppercase=bad)
||/ Name                Version             Architecture        Description
+++-----
=====
ii  eve-agent              7.0.0-XX           amd64               Agent
for EVE-NG Sat Cluster member
root@eve-sat01:~#
```

⚠ IMPORTANT NOTE: If your Network interfaces order has been changed, please follow instruction to section **17.7**

15.7 Bare hardware (BM) server EVE Satellite installation

15.7.1 BM Satellite server installation EVE PRO Full ISO

Download EVE PRO Full ISO distribution image:

<https://www.eve-ng.net/index.php/download/>

⚠ Bare Metal Server Bare metal BIOS, System and Security settings

Navigate to System BIOS Settings > Boot Settings:

Boot Mode > UEFI

Navigate to System BIOS Settings > Processor Settings:

Set Virtualization Technology to Enabled
Set X2APIC Mode to Enabled

Navigate to System BIOS Settings > Integrated Devices:

Set SR-IOV Global Enable to Enabled
Set I/OAT DMA Engine to Enabled

Navigate to System BIOS Settings > System Security:

TPM Security: OFF
Secure Boot: Disabled

Phase 1 (Ubuntu installation)

Step 1: Create a bootable DVD disk or USB flash drive (*Rufus tool is strongly recommended*) with a Full EVE ISO image. Boot your server from ISO. Chose Bare metal Option, following by following by Install BM EVE-NG Satellite and confirm with Enter.

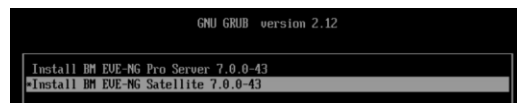

Step 2: Select English language. Confirm with Enter.

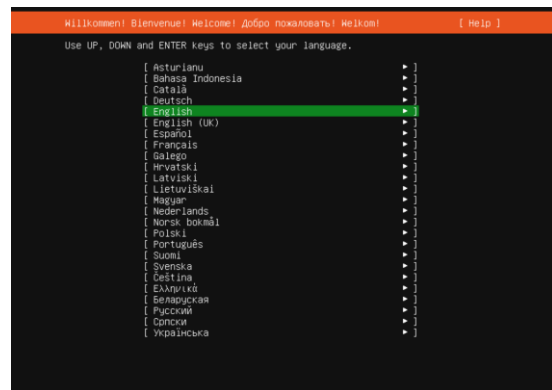

Step 3: Make sure if English US keyboard is selected and confirm with Enter.

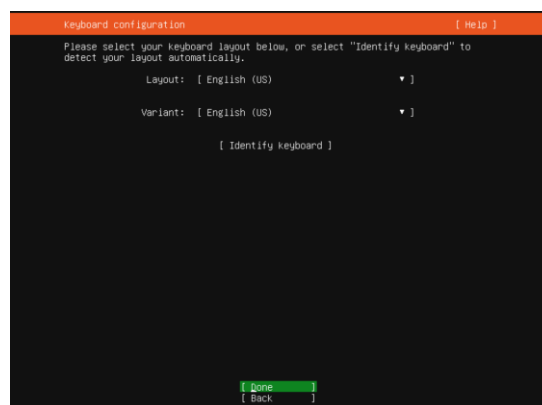

Step 12: Select "Continue" and confirm with Enter.

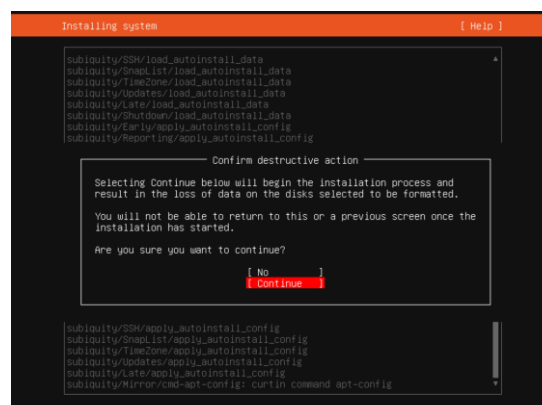

EVE BM Installation Phase 2 (EVE-NG installation)

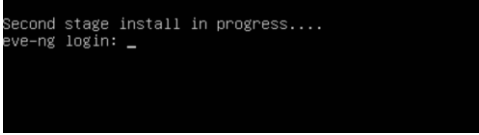
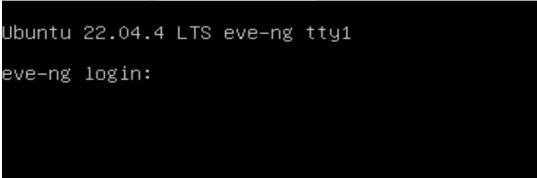
<p>Step 5: Please wait, the EVE-NG installation Phase 2 will start automatically.</p> <p>Do NOT login in this stage!</p> 	<p>Step 6. After installation EVE VM will auto reboot and EVE login screen will appear, login in CLI with root/eve and follow installation Phase 3</p> 
---	---

EVE BM Installation Phase 3 (Management IP setup and updates)

<p>Step 7: Setup EVEs Management IP address. A Static IP address setup is preferred.</p> <p>Follow steps in section:</p> <p>3.8.1 for static IP, 3.8.2 for DHCP IP</p>	<p>Step 8: Internet and DNS reachability is a MUST</p> <p>After your EVE is rebooted,</p> <p>Login to EVE CLI and type:</p>  <p>If required, follow steps in section: 5.1, 5.2</p>
<p>Step 9: (Optional) Air-Gapped Bare metal EVE Server setup from ISO can skip auto docker installation due slow iLO, iDRAC etc. virtual media connection to the server. For manual dockers installation, upload EVE-NG installation ISO to your EVE satellite server location: /tmp/. From CLI locate to the location and start dockers installation:</p> <pre>cd /tmp/ root@eve-sat:/tmp# ls eve-pro-prod-bm-7.0.1-9-full.iso root@eve-sat:install-iso-dockers</pre>	

Verification: Verify your EVE-Satellite server installation, type “dpkg -l eve-agent” command, it must display latest EVE Satellite version

```
root@eve-sat01:~# dpkg -l eve-agent
Desired=Unknown/Install/Remove/Purge/Hold
| Status=Not/Inst/Conf-files/Unpacked/halF-inst/trig-aWait/Trig-pend
|/ Err?=(none)/Reinst-required (Status,Err: uppercase=bad)
||/ Name                Version             Architecture        Description
+++-----
ii  eve-agent             7.0.0-XX           amd64              Agent for EVE-NG Sat Cluster member
root@eve-sat01:~#
```

15.7.2 BM Satellite installation Ubuntu legacy ISO

⚠ **IMPORTANT:** Internet must be reachable from your Server. This ISO installation requires internet access to get updates and install the latest EVE-PRO version from the EVE-NG repository. DNS must resolve names!

⚠ **Bare Metal Server Bare metal BIOS, System and Security settings**

Navigate to System BIOS Settings > Boot Settings:

Boot Mode > UEFI

Navigate to System BIOS Settings > Processor Settings:

Set Virtualization Technology to Enabled
Set X2APIC Mode to Enabled

Navigate to System BIOS Settings > Integrated Devices:

Set SR-IOV Global Enable to Enabled
Set I/OAT DMA Engine to Enabled

Navigate to System BIOS Settings > System Security:

TPM Security: OFF
Secure Boot: Disabled

Download Ubuntu Legacy Server installation image/ISO

<https://releases.ubuntu.com/noble/>

Phase 1 (Ubuntu installation)

Follow the Phase 1 BM Ubuntu installation Chapter 3.5.2

EVE Installation Phase 2 (EVE Satellite installation)

Step 28: SSH to your EVE IP using Putty or other SSH client. Log in as root user execute:

```
apt update
apt upgrade
```

Step 29: Run EVE Pro online installation script. (it is single line command below)

```
wget https://www.eve-ng.net/noble/install-eve-agent.sh
chmod +x install-eve-agent.sh
./install-eve-agent.sh
```

At the end of eve server installation, reboot eve

EVE Satellite Installation Phase 3 (Management IP setup and updates)

Step 30: After reboot login into your Agent server as root and follow Management IP setup instructions described in section 3.8.1 for Static IP

Verification: Verify your EVE-Satellite server installation, type “dpkg -l eve-agent” command, it must display latest EVE Satellite version

```
root@eve-sat01:~# dpkg -l eve-agent
Desired=Unknown/Install/Remove/Purge/Hold
| Status=Not/Inst/Conf-files/Unpacked/halF-conf/Half-inst/trig-aWait/Trig-pend
|/ Err?=(none)/Reinst-required (Status,Err: uppercase=bad)
||/ Name                Version             Architecture        Description
+++=====
=====
ii  eve-agent              7.0.0-XX           amd64               Agent for EVE-NG Sat
Cluster member
root@eve-sat01:~#
```

⚠ IMPORTANT NOTE: If your Network interfaces order has been changed, please follow instruction to section 17.7

15.8 Google Cloud EVE Satellite installation

15.8.1 Google account

Pre-Requisites: Your EVE Master server must have Public IP address or static NAT to public IP to join GCP satellite.

Step 1: Connect to Google Cloud Platform (GCP)

<https://console.cloud.google.com/getting-started>

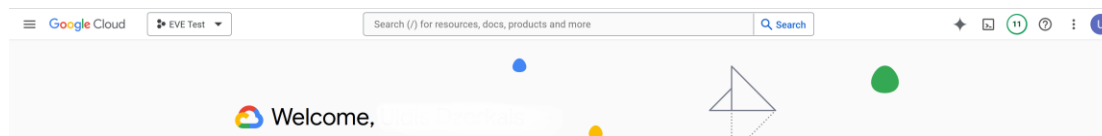

Step 2: Sign into GCP. Create a new GCP account if you do not already have one.

Step 3: Open your Google Project which assigned to your Google account

15.8.2 Preparing Ubuntu boot disk template

Step 1: On the left side navigate to Compute Engine and press “Activate Cloud Shell”

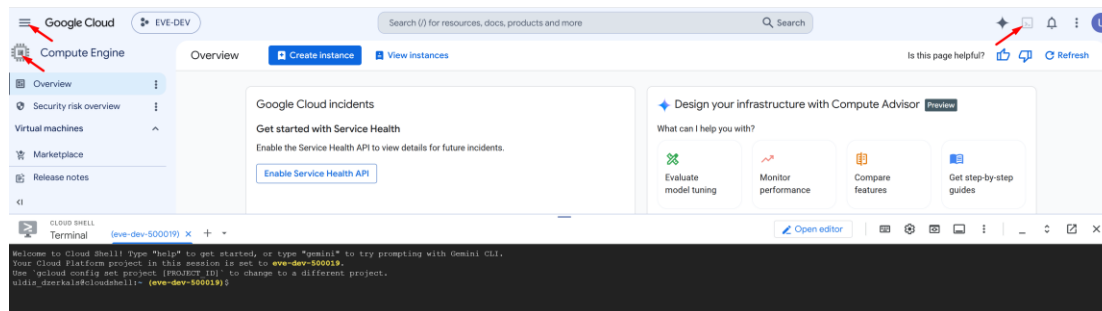

Step 2: Create a nested Ubuntu 24.04 image. Copy and paste the below command into the shell. Use copy/paste. ctrl +c/ctrl +v. **It is single line command.** Confirm with “enter”:

```
gcloud compute images create nested-ubuntu-noble --source-image-family=ubuntu-2404-lts-amd64 --source-image-project=ubuntu-os-cloud --licenses https://www.googleapis.com/compute/v1/projects/vm-options/global/licenses/enable-vmx
```

```
Welcome to Cloud Shell! Type "help" to get started, or type "gemin" to try prompting with Gemini CLI.
Your Cloud Platform project in this session is set to eve-dev-500019.
Use "gcloud config set project [PROJECT ID]" to change to a different project.
uid@dockerals@cloudshell: (eve-dev-500019) gcloud compute images create nested-ubuntu-noble --source-image-family=ubuntu-2404-lts-amd64 --source-image-project=ubuntu-os-cloud --licenses https://www.googleapis.com/compute/v1/projects/vm-options/global/licenses/enable-vmx
```

If it will ask enable API, answer **Y**. You will get the following output when your image is ready:

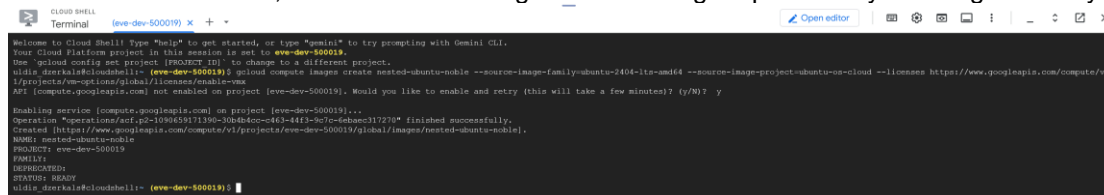

```
Cloud Shell Terminal (eve-dev-500019) x + x
Welcome to Cloud Shell! Type "help" to get started, or type "gemin" to try prompting with Gemini CLI.
Your Cloud Platform project in this session is set to eve-dev-500019.
Use "gcloud config set project [PROJECT ID]" to change to a different project.
uid@dockerals@cloudshell: (eve-dev-500019) gcloud compute images create nested-ubuntu-noble --source-image-family=ubuntu-2404-lts-amd64 --source-image-project=ubuntu-os-cloud --licenses https://www.googleapis.com/compute/v1/projects/vm-options/global/licenses/enable-vmx
API [compute.googleapis.com] not enabled on project [eve-dev-500019]. Would you like to enable and retry (this will take a few minutes)? (y/N)? y
Enabling service [compute.googleapis.com] on project [eve-dev-500019]...
Operation [Operations[act.pr-109665911366-136884cc-463-44f3-9c7c-6ebac-31727]*] finished successfully.
Created [https://www.googleapis.com/compute/v1/projects/eve-dev-500019/global/images/nested-ubuntu-noble].
NAME: nested-ubuntu-noble
PROJECT: eve-dev-500019
FAMILY:
ISPREPARED:
STATUS: READY
uid@dockerals@cloudshell: (eve-dev-500019)
```

15.8.3 Network MTU 1500 settings and firewall rules for GCP

If your GCP VM is expected to be as a part of EVE-NG Cluster system please complete the MTU network settings and firewall rules setup before creating the instance.

NOTE: GCP VM by default has MTU 1460 set for the interfaces by default. You may require to set VM machine custom MTU (1500) which is commonly known default setting for ethernet. The MTU settings on the GCP interface must be adjusted if you want it to use as the part of EVE-NG cluster system.

Open the google cloud shell and press: Press “Activate Cloud Shell”

Copy the following commands in SHELL Cloud console:

```
##### Create 1500 MTU subnet #####

gcloud compute networks create mtu1500 --subnet-mode=auto --mtu=1500
--bgp-routing-mode=regional

##### Create 1500 MTU firewall rules #####

gcloud compute firewall-rules create wireguard-in --direction=INGRESS
--priority=1000 --network=mtu1500 --action=ALLOW --rules=udp:60569 --
source-ranges=0.0.0.0/0

gcloud compute firewall-rules create wireguard-out --direction=EGRESS
--priority=1000 --network=mtu1500 --action=ALLOW --rules=udp:60569 --
destination-ranges=0.0.0.0/0

gcloud compute firewall-rules create ssh-in --direction=INGRESS --
priority=1000 --network=mtu1500 --action=ALLOW --rules=tcp:22 --
source-ranges=0.0.0.0/0

gcloud compute firewall-rules create ssh-out --direction=EGRESS --
priority=1000 --network=mtu1500 --action=ALLOW --rules=tcp:22 --
destination-ranges=0.0.0.0/0
```

Firewall rules summary:

<input type="checkbox"/>	Name	Type	Targets	Filters	Protocols/ports	Action	Priority	Network ↑	Logs
<input type="checkbox"/>	ssh-out	Egress	Apply to all	IP	tcp:22	Allow	1000	mtu1500	Off
<input type="checkbox"/>	wireguard-out	Egress	Apply to all	IP	udp:60569	Allow	1000	mtu1500	Off
<input type="checkbox"/>	ssh-in	Ingress	Apply to all	IP	tcp:22	Allow	1000	mtu1500	Off
<input type="checkbox"/>	wireguard-in	Ingress	Apply to all	IP	udp:60569	Allow	1000	mtu1500	Off

15.8.4 Optional: GCP MTU 1500 Firewall rules for native console use

Open the google cloud shell and press: Press “Activate Cloud Shell”

Copy the following commands in SHELL Cloud console:

```
##### Create MTU 1500 firewall rules for native console use #####

gcloud compute firewall-rules create allow-all-in --direction=INGRESS
--priority=1000 --network=mtu1500 --action=ALLOW --rules=tcp:0-65535
--source-ranges=0.0.0.0/0

gcloud compute firewall-rules create allow-all-out --direction=EGRESS
--priority=1000 --network=mtu1500 --action=ALLOW --rules=tcp:0-65535
--destination-ranges=0.0.0.0/0
```

Summary FW rules.

<input type="checkbox"/>	Name	Type	Targets	Filters	Protocols/ports	Action	Priority	Network ↑	Logs
<input type="checkbox"/>	allow-all-out	Egress	Apply to all	IP	tcp:0-65535	Allow	1000	mtu1500	Off
<input type="checkbox"/>	allow-all-in	Ingress	Apply to all	IP	tcp:0-65535	Allow	1000	mtu1500	Off

15.8.5 Creating VM

Step 1: Navigate: Navigation Menu/Compute Engine/VM Instances and press “CREATE INSTANCE”

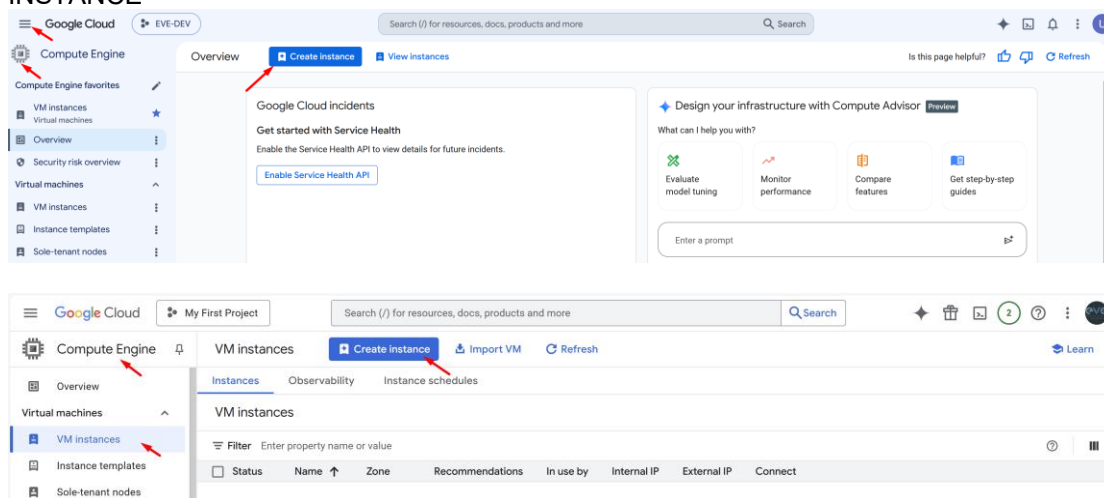

Step 2: Assign the name for your VM

Step 3: Set your own region and zone

Step 4: Edit your **Machine Configuration**. General-Purpose. Choose the series of CPU platform, Preferred are **Intel CPU Cascade Lake. Series N2 CPU**

← Create an instance ✦ Create VM from...

- Machine configuration
n2-standard-8, europe-west2-a
- OS and storage
Debian GNU/Linux 12 (bookworm)
- Data protection
Snapshot schedules
- Networking
1 network interface
- Observability
Install Ops Agent
- Security
- Advanced

Machine configuration

Name *
eve-v6

Region *
europe-west2 (London) Zone *
europe-west2-a

Region is permanent Zone is permanent

General purpose
 Compute-optimised
 Memory-optimised
 Storage optimised
 GPUs

Machine types for common workloads, optimised for cost and flexibility

Series	Description	vCPUs	Memory	CPU Platform
<input type="radio"/> C4	Consistently high performance	2 - 192	4 - 1,488 GB	Intel Emerald
<input type="radio"/> C4A	Arm-based consistently high performance	1 - 72	2 - 576 GB	Google Axion
<input type="radio"/> C4D	Preview Consistently high performance	2 - 384	3 - 3,024 GB	AMD Turin
<input type="radio"/> N4	Flexible and cost-optimised	2 - 80	4 - 640 GB	Intel Emerald
<input type="radio"/> C3	Consistently high performance	4 - 192	8 - 1,536 GB	Intel Sapphire
<input type="radio"/> C3D	Consistently high performance	4 - 360	8 - 2,880 GB	AMD Genoa
<input type="radio"/> E2	Low-cost day-to-day computing	0.25 - 32	1 - 128 GB	Intel Broadwell
<input checked="" type="radio"/> N2	Balanced price and performance	2 - 128	2 - 864 GB	Intel Cascade

Step 5: Choose Machine Type your desirable CPU and RAM settings.

Machine type

Choose a machine type with preset amounts of vCPUs and memory that suit most workloads. Or, you can create a custom machine for your workload's particular needs. [Learn more](#)

n2-standard-8 (8 vCPU, 4 core, 32 GB memory)

	vCPU	Memory
	8 (4 cores)	32 GB

Step 6: Edit your OS and Storage configuration. Press Change

- Machine configuration
n2-standard-8, europe-west2-a
- OS and storage
Debian GNU/Linux 12 (bookworm)
- Data protection
Snapshot schedules

Operating system and storage

Name	eve-v6
Type	New balanced persistent disk
Size	10 GB
Snapshot schedule	default-schedule-1
Licence type	Free
Image	Debian GNU/Linux 12 (bookworm)

Step 7. **IMPORTANT** Select Custom images, select OS nested-ubuntu-noble **you created previously**. Choose Boot Disk type: HDD disk type and size. HDD size can vary depends of your needs.

Boot disk

Select an image or snapshot to create a boot disk, or attach an existing disk. Can't find what you're looking for? Explore hundreds of VM solutions in [Marketplace](#)

Public images **Custom images** Snapshots Archive snapshots Existing disks

Source project for images *
eve-dev-500019 Change

Show deprecated images

Image *
nested-ubuntu-noble x86_64

Boot disk type *
SSD persistent disk

[Compare disk types](#)

Size (GB) *
100
Provision between 10 and 65536 GB

[Show advanced configuration](#)

Select Cancel

Step 8: Edit your Data Protection, select No backups.

- OS and storage
nested-ubuntu-jammy
- Data protection**
No backups
- Networking
1 firewall rule, 1 network interface
- Observability

Back up your data

You can automate recurring backups through a backup plan or snapshot schedule. [Learn more](#)

Backup plan
Back up the full VM. These immutable backups are secured by backup vault against accidental or malicious deletion. Managed by Backup and DR Service, a separate service from Compute Engine with independent certifications and accreditation. [Learn more](#)

Snapshot schedules
Back up disks only. This provides foundational protection at a lower cost. [Learn more](#)

No backups Neither VM nor disks will be backed up. If data is deleted or corrupted for any reason, you won't be able to recover it.

Step 9: Edit your Networking Allow https traffic.

- Machine configuration
n2-standard-8, europe-west2-a
- OS and storage
nested-ubuntu-jammy
- Data protection
No backups
- Networking**
1 firewall rule, 1 network interface
- Observability
Install Ops Agent

Networking

Firewall

Add tags and firewall rules to allow specific network traffic from the Internet

Allow HTTP traffic

Allow HTTPS traffic

Allow load balancer health checks

Network tags ?

Hostname ?
Set a custom hostname for this instance or leave it default. Choice is permanent

Step 10: Edit Security and Disable Secure Boot and vTPM

- OS and storage
nested-ubuntu-jammy
- Data protection
No backups
- Networking
1 firewall rule, 1 network interface
- Observability
Install Ops Agent
- Security**

Confidential VM service

Confidential Computing is disabled on this VM instance

[Enable](#)

Shielded VM

Turn on all settings for the most secure configuration.

Turn on Secure Boot

Turn on vTPM

Turn on integrity monitoring

VM access
Manage how users connect to the VM

Step 10: (Optional), Skip this step if your EVE VM will not a part of EVE-NG Cluster.
Before to select MTU1500 network please follow steps how to create it [3.6.7](#)
Select Networking/Network Interfaces.
Edit network interface and select created network: **MTU1500**

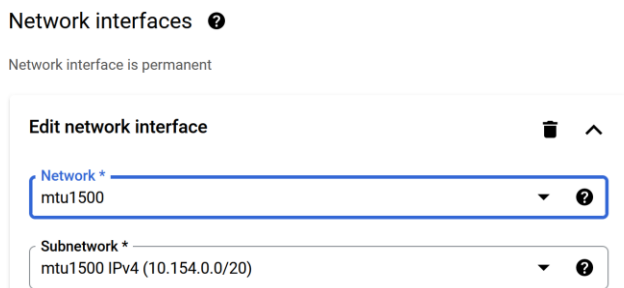

Step 11: [Create VM](#).

15.8.6 EVE-NG Satellite installation

Step 1: Click VM Instances to get access SSH to your VM, Connect to the VM with the first option “Open in browser window”

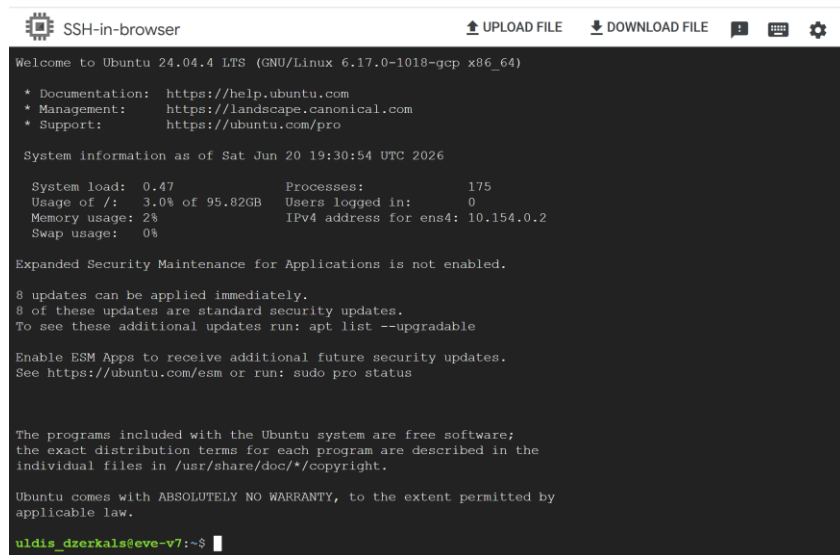

Step 2: Launch installation with:

Type the below command to become root:

```
sudo -i
```

Start EVE-PRO Satellite installation

```
wget https://www.eve-ng.net/noble/install-eve-agent.sh
chmod +x install-eve-agent.sh
./install-eve-agent.sh
```

Step 3: Update and upgrade your new EVE-Pro

```
apt update
```

```
apt upgrade
```

Confirm with Y

Step 4. Reboot EVE. Allow some time for reboot and then press "Reconnect"

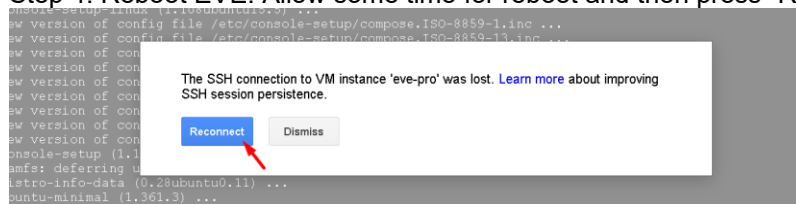

Step 5: **IMPORTANT:** Setup IP

Once the IP wizard screen appears, press **ctrl +c** and type the below command to become **root:**

```
sudo -i
```

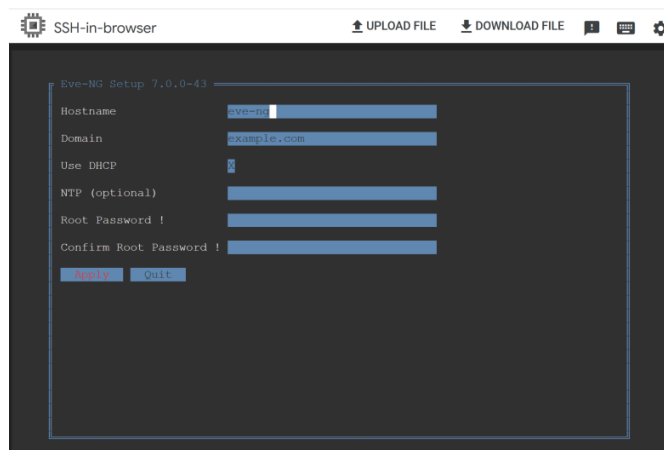

Now follow the IP setup wizard.

IMPORTANT: set IP as **DHCP!**

Step 6: Reboot

15.8.7 GCP Firewall rules for Cluster

If your EVE-NG Master server is behind the firewall, make sure it has allowed access to the GCP VM with following firewall rules

Node	Protocol	Port	Direction	Source	Destination
------	----------	------	-----------	--------	-------------

MASTER	TCP	22	ingress and egress	MASTER node IP	SATELLITE node IPs
MASTER	UDP	60569	ingress and egress	MASTER node IP	SATELLITE node IPs

15.9 Cluster Management

15.9.1 Join Satellite nodes to the Master

Step 1: Make sure that you have reachability between Master and Satellite nodes and firewall rules are configured in your network if FW is set between them. Firewall rules Section [15.3.1](#)

Step 2: Navigate: System/Cluster Management

The screenshot shows the EVE-NG web interface. In the top navigation bar, the 'System' menu is open, with 'Cluster settings' highlighted by a red arrow. Below this, the 'Cluster Settings' page is displayed, showing a table with one entry for the 'master' node. A red arrow points to the '+ ADD MEMBER' button in the top right corner of the table.

ID	Name	CPU	CPU Usage(%)	Memory	RAM Usage(%)	Swap	Swap Usage(%)	Disk	Disk Usage(%)	Actions
0	master	8	33%	31.3 MB	5%	8.0 MB	5%	193.3 GB	15%	+ ADD MEMBER

Step 3: Press Add Member and fill your Satellite details:

- Member's Name: use any suitable name for your satellite node
- IP address: Your satellite IP. In GCP version it will be public IP
- Member's Root Password: Your Satellite node password
- Press Add Member

The screenshot shows the 'Add New Member' form on the left and the 'Add Member Log' on the right. The form has fields for Member Name (sat001), IP Address (192.168.70.58), and Member's Root Password. The log shows the process of adding a new satellite node, including generating keys, copying files, and testing the connection.

Add New Member

Member Name:

IP Address: . . .

Member's Root Password:

ADD **CANCEL**

Add Member Log

```
Starting adding Sat sat001...
Generate Private Key for new Sat... OK
Get Public Key for new Sat... OK
Get EVE Public Key... OK
Generate SSH Key pair... OK
Cleaning host key for the new sat... OK
Copy rsa key the new sat... OK
Testing ssh connection to the new sat... OK
Check if wireguard config already exists... OK
Adding wireguard to sat... OK
Activate wireguard config locally... OK
Generate new client SSL certificateOK
Copying SSL cert to sat... OK
Restart remote agent... OK
Checking running remote agent... OK
```

CLOSE

Step 4: After certain of time Satellite will join to the Master

ID	Name	CPU	CPU Usage(%)	Memory	RAM Usage(%)	Swap	Swap Usage(%)	Disk	Disk Usage(%)	Actions
0	master	8	95	31.3 MB	95	8.0 MB	100	193.3 GB	100	
1	sat001	8	95	15.6 MB	95	4.0 MB	100	193.3 GB	100	[Stop] [Refresh]

15.9.2 Remove Satellite nodes from the Master

Step 1: Navigate: System/Cluster Management

Step 2: Press Delete Member

ID	Name	CPU	CPU Usage(%)	Memory	RAM Usage(%)	Swap	Swap Usage(%)	Disk	Disk Usage(%)	Actions
0	master	8	95	31.3 MB	95	8.0 MB	100	193.3 GB	100	
1	sat001	8	95	15.6 MB	95	4.0 MB	100	193.3 GB	100	[Delete Member] [Stop] [Refresh]

15.9.3 Re-join Satellite nodes from the Master

Step 1: Navigate: System/Cluster Management

Step 2: Press Delete Member

ID	Name	CPU	CPU Usage(%)	Memory	RAM Usage(%)	Swap	Swap Usage(%)	Disk	Disk Usage(%)	Actions
0	master	8	95	31.3 MB	95	8.0 MB	100	193.3 GB	100	
1	sat001	8	95	15.6 MB	95	4.0 MB	100	193.3 GB	100	[Delete Member] [Stop] [Refresh]

Step 3: IMPORTANT! Go to Satellite node CLI and reset IP address. It is necessary to refresh SSH key for re-join Satellite to the Master.

CLI:

Login as root to the Satellite node and type:

```
rm -fr /etc/wireguard/*
rm -f /opt/unetlab/go/eve-agent.yaml
ip link set wg0 down
ip link del wg0
rm -f /root/.ssh/authorized_keys
```

Step 4: Join Satellite accordingly Section 15.9.1

15.9.4 Change Satellite IP address

Step1: Remove satellite from cluster system accordingly chapter [15.9.2](#)

Step 2: Login as root to the Satellite node and type:

```
rm -f /opt/ovf/.configured
su -
```

EVE Satellite will initiate IP setup wizard. Follow Section [3.8.1](#)

15.10 Cluster assignment hierarchy

15.10.1 Single Satellite server assignment

The Cluster Hierarchy depends which of the option is assigned:

Option 1 - User assignment to cluster

Option 2 - Lab assignment

Option 3 - Individual node assignment

	Cluster assignment Options	Description	Conditions
Option 1	EVE WEB GUI Management/User Management/Edit User/Satellite	Admin, Editor or User is forced to use only Cluster Satellite assigned by Admin. User cannot edit Lab or set individual nodes for other cluster Satellites. This Option can be assigned or edited only by Admin	If User account is set to use specific Satellite server, Users can NOT apply Options 2 and 3. This option applies to Admin user as well until Admin user will set his account to use "any"
Option 2	Lab is set to use Specific Cluster Satellite. Select Lab you want Edit/Select Satellite	If Option 1 is set to "any", then Admin or Editor is allowed to set Lab settings globally to use Lab on specific Cluster Satellite	Admin or Editor user accounts Satellite assignment (option 1) must be set to "any"
Option 3	Set lab nodes individually run-on specific Cluster server	Admin or Editor can assign single Lab nodes run on specific Cluster Satellite servers	Options 1 and 2 must be set to "any"

Lab User is not allowed to use any of options above

15.10.1.1 User assignment to the dedicated Satellite (Option 1)

Step 1: Navigate to Management/User Management

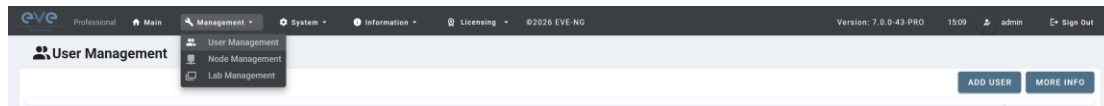

Step 2: Create or Edit existing user

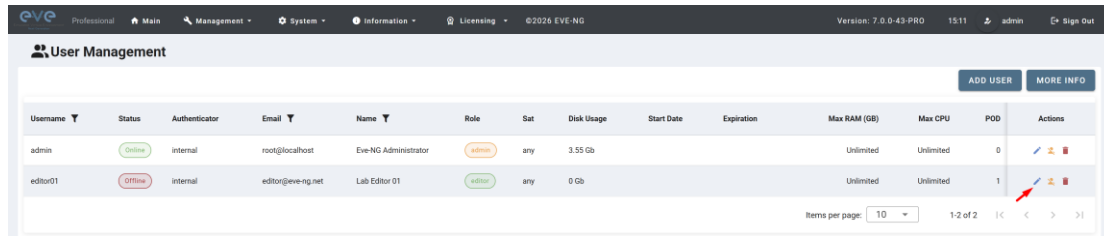

Step 3: Choose the Satellite or Satellites to be assigned for this user.

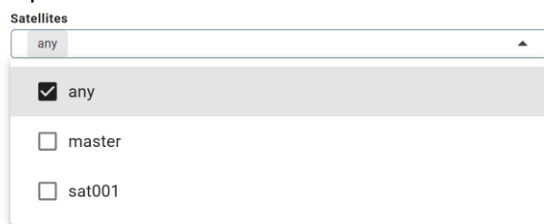

Step 4. User will be locked and will use only selected Satellite node. Editor and User roles cannot change or choose other satellite members. Use select Satellite from list which is dedicated for user.

15.10.1.2 Lab assignment to dedicated cluster Satellite (Option 2)

Step 1: Navigate to Lab tree, Select Lab you want assign for dedicated Satellite

Step 2: Click "Edit"

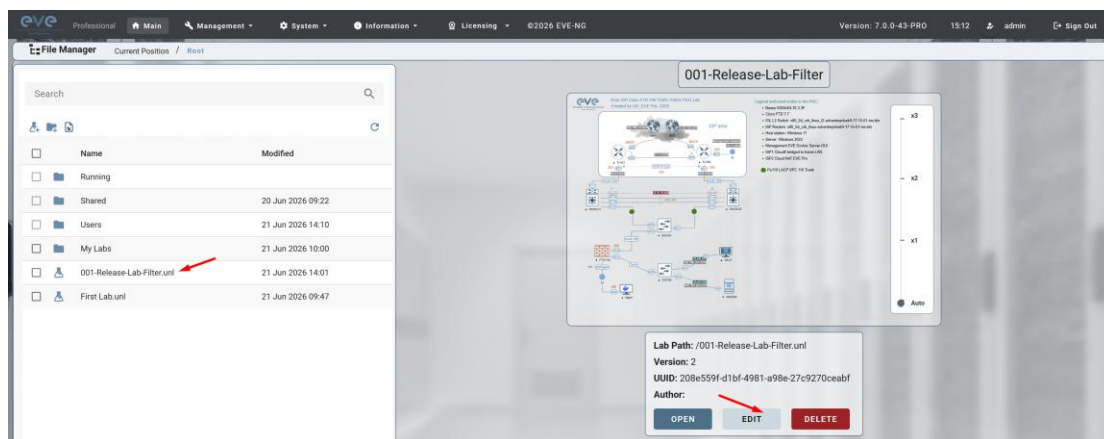

Step 3: Select Satellite for Lab

Lab properties

Path: /001-Release-Lab.unl

Name: 001-Release-Lab

Version: 1

Author: UD

Satellite: any

Shared with: any

Config Scrip: master

Lab Count: 1

Default link: sat001

Display Grid:

Lab Description:

Lab tasks:

SAVE CANCEL

Note: Accordingly, Cluster hierarchy matrix above, this Option will be in force if Option 1 is left to default “any”

15.10.1.3 Creating EVE labs in Cluster (Option 3)

Step 1: Create new or edit your existing lab

Step 2: On lab Node right click/edit

Step 3: Select preferred Satellite node and click save

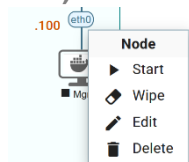

Satellite: any

Delay (s): 0

Y Position: 792

Option to assign cluster nodes for single lab devices.

Lab Side bar/Nodes, column SATELLITE, Select your cluster satellites for devices in the lab.

Configured Nodes Filter by Status: All

Lab Assigned Resources (Running/ Total) vCPU: 10/ 16 RAM: 47/ 59 GB HDD: 10.44 GB

ID	NAME	SATELLITE	TEMPLATE	BOOT IMAGE	CPU	CPU USAGE
1	R-XE2	master	io1	x86_64_crb_linux-adventureprisek9-ms.bin	n/a	0.0%
2	R-XE1	master	io1	x86_64_crb_linux-adventureprisek9-ms.bin	n/a	0.0%
3	NXOS-01	master	nxosv9k	nxosv9k-9300v64-10.3.3F	2	49.1%
4	NXOS-02	master	nxosv9k	nxosv9k-9300v64-10.3.3F	2	17.0%
5	SW-INT	master	io1	x86_64_crb_linux_j2-adventureprisek9-ms.bin	n/a	0.0%
6	ASAv01	master	asav	asav-9-20-2-21	1	15.0%
7	ASAv02	master	asav	asav-9-20-2-21	1	16.0%
8	Mgmt	any	docker	eve-gui-server:latest	2	0.0%
9	Win11	SAT01B	w1n	w1n-11-x64-23H2v2A	4	0.0%
10	WS2022	SAT01B	winsrvr	winsrvr-S2022-x64-21H2AL	4	0.5%

Note: Accordingly, Cluster hierarchy matrix above, this Option will be in force if Options 1 and 2 settings are left default “any”

15.10.2 Multi Satellite servers’ assignment

This option is dedicated for advanced EVE user assignment for multi-Satellite servers. User can choose and assign and run their labs to run on dedicated servers only.

15.10.2.1 Multi Satellites user Profiles

User Profile and Lab nodes Satellite use hierarchy

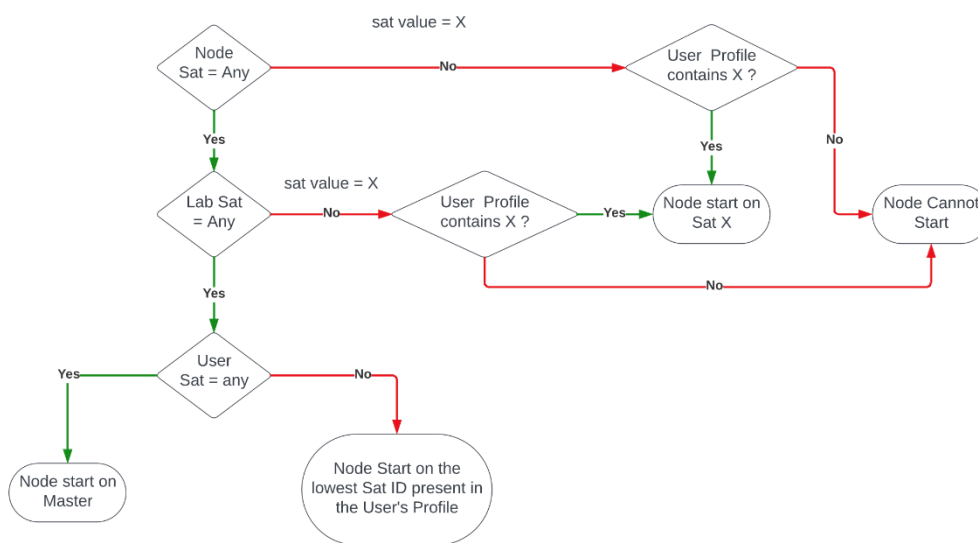

15.10.2.2 User assignment to the dedicated Satellites

Step 1: Navigate to Management/User Management

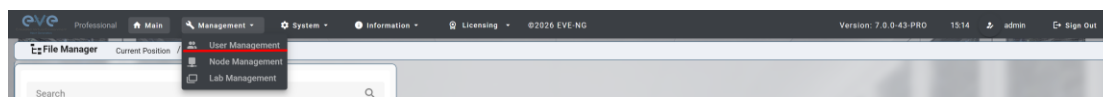

Step 2: Create or Edit existing user

Username	Status	Authenticator	Email	Name	Role	Sat	Disk Usage	Start Date	Expiration	Max RAM (GB)	Max CPU	POD	Actions
admin	Online	internal	root@localhost	Eve-NG Administrator	admin	any	3.55 Gb			Unlimited	Unlimited	0	[edit] [delete] [info]
editor01	Offline	internal	editor@eve-ng.net	Lab Editor 01	editor	any	0 Gb			Unlimited	Unlimited	1	[edit] [delete] [info]

Step 3: The User Cluster Server value “any” is set by default. Choose the Satellite or Satellites to be assigned for this user.

Edit User

User Name: test2
 Password: [masked]
 Confirm Password: [masked]
 Authentication: internal
 Email: uldis.dzerkals@gmail.com
 Name: Lab Editor 2

Role: Lab Editor
 StickyConsole: any
 Satellites: sat001, sat002
 any
 master
 sat001
 sat002

[SAVE] [CANCEL]

Satellites assignment per user (Editor or User) require Administrator account

Set the Cluster Satellites for the Lab Editor. This applies for Lab Editor roles. Lab Editor will stick to selected Satellites. Lab Editor will be forced and allowed to use only selected Satellite server or choose between the Satellite servers if it is assigned more than one server. If the Lab has set to use any satellite server, then Lab Editor will be assigned to use lowest satellite ID.

Example: Lab Editor has assigned to use SAT1 (ID1) and SAT2 (ID2). The Lab has set to use “any” satellite. This Editor lab will be automatically assigned to use first available Satellite with lowest ID1, SAT1.

Editor has rights to change Satellite per node for *own created Labs*.

Editor cannot change satellite assignments for Shared Lab. The Shared Lab is recommended to set “any” Cluster Satellite,

If the Lab is created on the Satellite servers which are NOT in the Lab Editor allowed Satellites list, this lab will not start.

Example: Lab is created to use Master server only, but Lab Editor is allowed to use only SAT1 Server. Lab Editor will not be allowed to start this Lab.

If the Lab contains nodes which are assigned to run on the Satellite server which is NOT in Lab Editor allowed Satellites list, this node will not start.

Example: Lab several nodes are assigned to use Master server only, but Lab Editor is allowed to use only SAT1 Server. Lab Editor will not be allowed to start these nodes.

Set the Cluster Satellites for the Lab User. This applies for Lab User roles. Lab User will stick to selected Satellites. Lab User will be forced and allowed to use only selected Satellite server or servers.

Example: Lab User has assigned to use SAT1 (ID1) and SAT2 (ID2). The Lab has set to use “any” satellite. This Lab User lab will be automatically assigned to use first available Satellite with lowest ID1, SAT1.

If the Lab is created on the Satellite servers which are NOT in the Lab User allowed Satellites list, this lab will not start.

Example: Lab is created to use Master server only, but Lab User is allowed to use only SAT1 Server. Lab User will not be allowed to start this Lab.

If the Lab contains nodes which are assigned to run on the Satellite server which is NOT in Lab User allowed Satellites list, this node will not start.

Example: Lab several nodes are assigned to use Master server only, but Lab User is allowed to use only SAT1 Server. Lab User will not be allowed to start these nodes.

Option to assign cluster nodes for single lab devices.

Lab Side bar/Nodes, column SATELLITE, Select your cluster satellites for devices in the lab.

Configured Nodes Filter by Status: All

Lab Assigned Resources (Running/ Total) vCPU: 10/ 16 RAM: 47/ 59 GB HDD: 10.44 GB

ID	NAME	SATELLITE	TEMPLATE	BOOT IMAGE	CPU	CPU USAGE
1	R-XE2	master	io1	x86_64_crb_linux-adventureprisek9-ms.bin	n/a	0.0%
2	R-XE1	master	io1	x86_64_crb_linux-adventureprisek9-ms.bin	n/a	0.0%
3	NXOS-01	master	nxosv9k	nxosv9k-9300v64-10.3.3F	2	49.8%
4	NXOS-02	master	nxosv9k	nxosv9k-9300v64-10.3.3F	2	77.0%
5	SW-INT	master	io1	x86_64_crb_linux_i2-adventureprisek9-ms.bin	n/a	0.0%
6	ASAv01	master	asav	asav-9-20-2-21	1	16.0%
7	ASAv02	master	asav	asav-9-20-2-21	1	16.0%
8	Mgmt	any	docker	eve-gui-server:latest	2	0.0%
9	Win11	SAT01B	w1n	win-11-x64-23H2v2A	4	0.0%
10	WS2022	SAT01B	wInserver	wInserver-S2022-x64-21H2AL	4	0.5%

15.10.3 Master images synchronization with Satellites

Once you have assigned certain lab device to use cluster Satellite node and start it, the automatic rsync process is initiated from Master node copy necessary image to the Satellite cluster member. During rsync process between Master and Satellite lab device will display “Clock” sign beside device. After image rsync process is completed, Lab device will turn sign to “Play”, running state.



Large size lab devices/images, rsync process can take some time. It depends of the network speed between the cluster members.

Once the image is copied into Satellite node, lab device will start immediately. RSYNC process initiates only once if particular device image does not exist on Satellite node.

15.11 Cluster system monitoring

15.11.1 Cluster Monitoring page

Navigate: System/Cluster Management

Information columns displaying live information about cluster members utilization

Satellite nodes have option to reboot or shutdown.

If the cluster is healthy and fully functional, the Status column will display “GREEN” name label beside the cluster members.

Cluster Settings

ID	Name	CPU	CPU Usage(%)	Memory	RAM Usage(%)	Swap	Swap Usage(%)	Disk	Disk Usage(%)	Actions
0	master	8	100%	31.3 MB	9%	8.0 MB	9%	193.3 GB	10%	
1	sat001	8	1%	15.6 MB	5%	4.0 MB	9%	193.3 GB	10%	⏻ 🔌 🔄

Items per page: 10 1-2 of 2

If the Satellite node is down or not reachable, the Status column will display “RED” name label.

Cluster Settings

ID	Name	CPU	CPU Usage(%)	Memory	RAM Usage(%)	Swap	Swap Usage(%)	Disk	Disk Usage(%)	Actions
0	master	8	2%	31.3 MB	9%	8.0 MB	9%	193.3 GB	10%	
1	sat001	8	2%	15.6 MB	5%	4.0 MB	9%	193.3 GB	10%	⏻ 🔌 🔄

Items per page: 10 1-2 of 2

If the Satellite node is reachable but malfunctioning, Agent service is stopped or crashed, Status will be displayed as ‘YELLOW’ name label. (stop/reboot possible)

Cluster Settings

ID	Name	CPU	CPU Usage(%)	Memory	RAM Usage(%)	Swap	Swap Usage(%)	Disk	Disk Usage(%)	Actions
0	master	8	2%	31.3 MB	9%	8.0 MB	9%	193.3 GB	10%	
1	sat001	8	2%	15.6 MB	5%	4.0 MB	9%	193.3 GB	10%	⏻ 🔌 🔄

Items per page: 10 1-2 of 2

15.11.2 Satellite disaster recovery

Use case: If a satellite node crashed, was powered off while lab devices were running on it or the connection to the satellite was lost, the Master node will still have these nodes in a running state even if this is no longer the case.

To remediate this situation, you have to purge the local state information about the satellite before recovering the satellite, booting it back up or recovering the connection.

Step 1: To verify status of lab nodes:

Navigate Management/Nodes management. If you observing that crashed Satellite nodes are still alive and visible follow Step 2

Node management here you can manage EVE-NG running nodes

Running node(s)

Labname	Lab ID	Username	Sat	Node Name	CPU usage (%)	RAM usage (%)	Disk usage (GB)	Template	Action
/A_Trunka	1	uldis	master	PC5-2	0	0.03	0.0035	docker	
/A_Trunka	1	uldis	master	PC5-1	0	0.02	0.0035	docker	
/A_Trunka	1	uldis	master	PC10-2	0	0.02	0.0035	docker	
/A_Trunka	1	uldis	master	PC10-1	0	0.02	0.0035	docker	
/A_Trunka	1	uldis	sat2	SW2	0.72	0.63	0.0101	viosl2	
/A_Trunka	1	uldis	master	PC5-1	0	0.02	0.0031	docker	
/A_Trunka	1	uldis	sat2	SW4	0.63	0.58	0.0101	viosl2	
/A_Trunka	1	uldis	master	PC10-1	0	0.03	0.0035	docker	
/A_Trunka	1	uldis	master	PC5-2	0	0.02	0.0031	docker	
/A_Trunka	1	uldis	master	SW3	0.4	0.24	0.0101	viosl2	
/A_Trunka	1	uldis	master	SW1	0.38	0.23	0.0101	viosl2	
/A_Trunka	1	uldis	sat2	PC10-2	0	0.13	0	docker	

Step 2. Navigate: System/Cluster Management
Use **Purge** Button to clean crashed Satellite devices from the Master.

Cluster Settings

+ ADD MEMBER

ID	Name	CPU	CPU Usage(%)	Memory	RAM Usage(%)	Swap	Swap Usage(%)	Disk	Disk Usage(%)	Actions
0	master	8	2%	31.3 MB	1%	8.0 MB	9%	193.3 GB	1%	
1	sat001	8	1%	15.6 MB	3%	4.0 MB	9%	193.3 GB	1%	

Items per page: 10 1-2 of 2

Confirm Purge

Are you sure you want to purge member "sat001" ?
This action will remove console entries for this member from the database.

PURGE CANCEL

15.11.3 EVE Cluster Status

Navigate: System/Cluster Management

Cluster Settings

+ ADD MEMBER

ID	Name	CPU	CPU Usage(%)	Memory	RAM Usage(%)	Swap	Swap Usage(%)	Disk	Disk Usage(%)	Actions
0	master	8	1%	31.3 MB	2%	8.0 MB	9%	193.3 GB	1%	
1	sat001	8	1%	15.6 MB	3%	4.0 MB	9%	193.3 GB	10%	

Items per page: 10 1-2 of 2

15.11.4 Cluster monitoring cli commands

On EVE Master:
Cluster System CLI Commands:

Check Cluster status:

```
root@eve-ng:~# unl_wrapper -a showcluster
Jan 31 23:56:52 Jan 31 23:56:52 Online Check state: Valid
Cluster Status:
#####
0 master Online ( Local )
1 sat1 Online
2 sat2 Online
#####
```

```
root@eve-ng:~#
```

SSH to the Satellite node from the Master status:

```
ssh 172.29.130.<satId>
```

```
#####Example SSH to SAT1#####
```

```
root@eve-ng:~# ssh 172.29.130.1
```

```
Welcome to Ubuntu 22.04.5 LTS (GNU/Linux 4.20.17-eve-ng-uksm-wg+x86_64)
```

- * Documentation: <https://help.ubuntu.com>
- * Management: <https://landscape.canonical.com>
- * Support: <https://ubuntu.com/advantage>

- * Canonical Livepatch is available for installation.
 - Reduce system reboots and improve kernel security. Activate at: <https://ubuntu.com/livepatch>

```
Last login: Sun Jan 31 22:24:06 2021 from 10.6.6.14
```

```
root
```

```
root@eve-sat1:~#
```

Check Cluster Satellite version:

```
root@eve-sat03:~# dpkg -l eve-agent
```

```
Desired=Unknown/Install/Remove/Purge/Hold
```

```
|          Status=Not/Inst/Conf-files/Unpacked/halF-conf/Half-inst/trig-aWait/Trig-pend
```

```
|/ Err?=(none)/Reinst-required (Status,Err: uppercase=bad)
```

```
||/ Name                               Version                               Architecture
```

```
Description
```

```
+++-----
```

```
=====  
ii eve-agent                            7.0.0-XX                             amd64                Agent
```

```
for EVE-NG Sat Cluster member
```

```
root@eve-sat03:~#
```

15.12 Cluster system upgrade

Pre-requisites: The Master node must reach internet and resolve DNS.

On the EVE Master CLI run commands:

```
apt update  
apt upgrade
```

The cluster Satellites will upgrade automatically with EVE master. There no need any extra upgrade run for Satellite nodes.

To update manually Satellite nodes from Master EVE:

```
root@eve-ng:~# unl_wrapper -a updatesat
```

```
Feb 01 00:03:24 Feb 01 00:03:24 Online Check state: Valid
```

```
Feb 01 00:03:24 update sat 1
```

```
ii eve-agent                            7.0.0-XX                             amd64                Agent for EVE-NG Sat  
Cluster member
```

```
Feb 01 00:03:24 update sat 2
```

```
ii  eve-agent          7.0.0-XX      amd64          Agent for EVE-NG Sat
Cluster member
root@eve-ng:~#
```

16 EVE Troubleshooting

16.1 CLI diagnostic information display commands

16.1.1 Display full EVE Pro diagnostic

```
eve-info
```

16.1.2 Display the currently installed EVE Pro version:

```
dpkg -l eve-ng-pro
```

```
root@eve-ng:~# dpkg -l eve-ng-pro
Desired=Unknown/Install/Remove/Purge/Hold
| Status=Not/Inst/Conf-files/Unpacked/halF-conf/Half-inst/trig-aWait/Trig-pend
|/ Err?=(none)/Reinst-required (Status,Err: uppercase=bad)
||/ Name           Version          Architecture Description
++-----+-----+-----+-----+
ii  eve-ng-pro       7.0.0-43        amd64        A new generation software for networking labs.
root@eve-ng:~#
```

16.1.3 Display if EVEs Intel VT-x/EPT option on/off:

```
kvm-ok
```

```
root@eve-ng:~# kvm-ok
INFO: /dev/kvm exists
KVM acceleration can be used
root@eve-ng:~#
```

16.1.4 Display EVEs CPU INFO:

```
lscpu
```

```
root@eve-ng:~# lscpu
Architecture:          x86_64
CPU op-mode(s):        32-bit, 64-bit
Byte Order:             Little Endian
CPU(s):                 24
On-line CPU(s) list:   0-23
Thread(s) per core:    1
Core(s) per socket:    1
Socket(s):              24
NUMA node(s):          4
Vendor ID:              GenuineIntel
CPU family:             6
Model:                  44
Model name:             Intel(R) Xeon(R) CPU           X5680  @ 3.33GHz
Stepping:               2
CPU MHz:                3324.053
BogoMIPS:               6650.00
Virtualization:         VT-x
Hypervisor vendor:     VMware
```

16.1.5 Display EVEs CPU manufacturer:

```
lsmod | grep ^kvm_
```

```
root@eve-ng:~# lsmod | grep ^kvm_
kvm_intel                212992    74
root@eve-ng:~#
```

15.1.4 Display

16.1.6 Display EVEs HDD utilization.

If the eve-ng-vg-root reaches 98% or 100% then you will need to expand the HDD in order to continue using EVE. The Solution to expand your HDD is described in section 16.1

```
df -h
```

```
root@eve-ng:~# df -h
Filesystem                Size      Used Avail Use% Mounted on
udev                     40G         0   40G   0% /dev
tmpfs                     7.9G       52M   7.9G   1% /run
/dev/mapper/eve-ng-vg-root 681G       370G   283G   57% /
tmpfs                     40G         0   40G   0% /dev/shm
tmpfs                     5.0M         0   5.0M   0% /run/lock
tmpfs                     40G         0   40G   0% /sys/fs/cgroup
/dev/sda1                  472M       83M   365M  19% /boot
root@eve-ng:~#
```

16.1.7 Display EVEs Bridge interface status

```
brctl show
```

```
root@eve-ng:~# brctl show
bridge name      bridge id                STP enabled  interfaces
docker0          8000.0242c0db8435        no           eth0
nat0             8000.000000000000        no           eth1
pnet0            8000.000c29d0aa94        no           vuml1_0_1_0
pnet1            8000.000c29d0aabc        no           eth2
pnet2            8000.000c29d0aa9e        no           eth3
pnet3            8000.000c29d0aaa8        no           eth4
pnet4            8000.000c29d0aab2        no
pnet5            8000.000000000000        no
pnet6            8000.000000000000        no
pnet7            8000.000000000000        no
pnet8            8000.000000000000        no
pnet9            8000.000000000000        no
```

16.1.8 Display EVEs system services status

```
systemctl list-unit-files --state=enabled
```

```
root@eve-ng:~# systemctl list-unit-files --state=enabled
UNIT FILE          STATE
accounts-daemon.service  enabled
autovt@.service        enabled
capdog.service         enabled
cpulimit.service       enabled
cron.service           enabled
docker.service         enabled
getty@.service         enabled
lvm2-monitor.service   enabled
mysql.service          enabled
networking.service     enabled
open-vm-tools.service   enabled
openvswitch-switch.service  enabled
ovfstartup.service     enabled
resolvconf.service     enabled
rsyslog.service        enabled
ssh.service            enabled
sshd.service           enabled
syslog.service         enabled
systemd-timesyncd.service  enabled
unattended-upgrades.service  enabled
ureadahead.service     enabled
dm-event.socket        enabled
docker.socket          enabled
lvm2-lvmetad.socket    enabled
lvm2-lvmpolld.socket   enabled
uuuid.socket           enabled
remote-fs.target       enabled
apt-daily-upgrade.timer  enabled
apt-daily.timer         enabled
```

16.2 Correct EVE server network interfaces order

NOTE: Sometimes after installation the Ubuntu or ESXi (known reported issue), your system can change network interfaces (NICs) order.

EVE-NG, starting from version PE 5.0.1-77 has implemented NIC order script to fix your network interfaces order.

1. Log into your EVE as SSH, or native VNC server console as root user.
2. Navigate to `cd /opt/ovf/`
3. Run the script:

```
root@eve-ng-master:~# cd /opt/ovf/
root@eve-ng-master:/opt/ovf# ./nicorder-wizard
```

4. Follow the instructions on the screen to re-order your interfaces.

```
Reorder Nics
*****
UP/DOWN   Select interface
LEFT/RIGHT Move interface
ESC       Discard change
ENTER     Accept new order

> enx000c2967dbcb eth0 -> eth0
  enx000c2967dbd5 eth1 -> eth1
  enx000c2967dbdf eth2 -> eth2
  enx000c2967dbe9 eth3 -> eth3
```

5. After correction the initial boot order will be saved on your EVE server
6. Reboot your EVE server, the new order settings will be in force now.

NOTE: if you will run order script again, it will show you last saved order.

16.3 Expand EVEs System HDD

⚠ IMPORTANT NOTE: DO NOT expand your current/existing HDD on your EVE VM!

16.3.1 HDD space alert

Important: by default, EVE will trigger alerts if there are 3GB or less HDD space available. Additional nodes will not start until more space is added or freed up. A link is provided in the notification blinking on how to properly add an additional HDD.

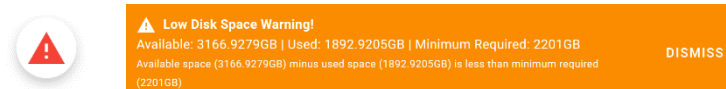

To edit HDD space threshold for the alert is customizable. please follow section: [7.4.1](#)

Disk Critical Size

Minimal free space (GB)

16.3.2 Expand HDD on VMware Workstation

Expanding your EVEs system HDD is achieved by adding an additional HDD to your EVE VM.

Step 1: Stop all your labs and shutdown EVE.

Use EVE CLI command: **shutdown -h now**

Step 2: Go to edit VM settings and add a new Hard drive. Then click Next.

Step 3: Leave the recommended SCSI HDD option and then click Next

Step 4: Make sure you have selected the option “Create a new Virtual disk.”

Step 5: Set your desirable HDD Size; example 200GB.

Step 6: Make sure you have set the option “Store Virtual disk as a single file” and then click Next

Step 7: Optional: Specify the location of where your new HDD will be stored, then click Finish.

Step 8: Boot your EVE VM, HDD size will be expanded automatically. To verify, use the command to verify HDD utilization referenced in section 16.1.6

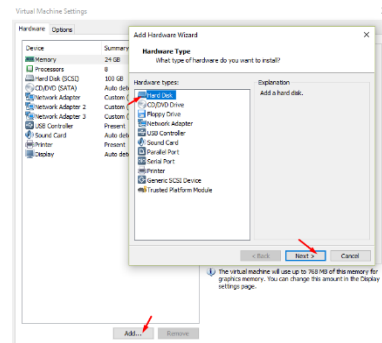

16.3.3 Expand your HDD on ESXi

Expanding your EVEs system HDD is achieved by adding an additional HDD to your EVE VM.

Step 1: Stop all your labs and shutdown EVE.

Use EVE CLI command: **shutdown -h now**

Step 2: Go to edit VM settings and add a new Hard drive. Then click Next

Step 3: Make sure you have selected the option “Create a new Virtual disk.” Then click Next

Step 4: Set your desirable HDD Size; example 200GB.

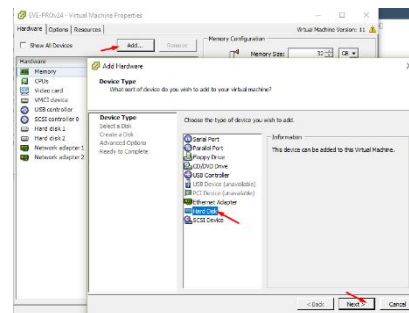

Step 5: It is recommended to set the **Thick Provision Lazy Zeroed** HDD option.

Step 6: Specify the location of where your new HDD will be stored and then click Next

Step 7: Leave the recommended SCSI HDD option as is and click Finish.

Step 8: Boot your EVE VM, the HDD size will be expanded automatically. To verify, use the command to verify HDD utilization referenced in section 16.1.6

16.3.4 Expand your HDD on a Bare Metal EVE Server

It is a complicated process to expand a HDD for a bare metal EVE server.

<https://www.eve-ng.net/wp-content/uploads/2023/03/EVE-Doc-3023-LVM-HDD-systems.pdf>

Please open a ticket in our Live chat support for advice.

<https://webchat.eve-ng.net/login/>

Use a google account to join in the Live Chat or create new chat account.

16.4 Reset Management IP

Type the following commands into the CLI followed by enter:

```
rm -f /opt/ovf/.configured
```

```
su -
```

<http://www.eve-ng.net/documentation/installation/bare-installIP> address setup wizard. Please follow the steps in section [3.8.1](#) for Static IP or [3.8.2](#) for DHCP IP setup.

16.5 EVE PRO SQL Database recovery

Starting EVE PRO version 3.0.1-21 and later, you can recover SQL user database in case of disaster:

```
unl_wrapper -a restoredb
```

16.6 EVE PRO Migration from host to host

The best option to migrate all data from one EVE-NG host to another is to use EVE-NG Backup solution. Please refer section [19](#)

16.7 EVE Log files

EVE log Files can be obtained from the System Logs page under the System dropdown menu

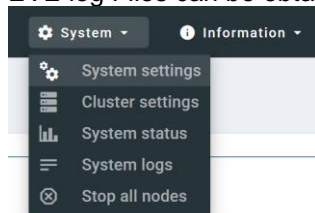

Use the menu to collect log file data you are interested in.

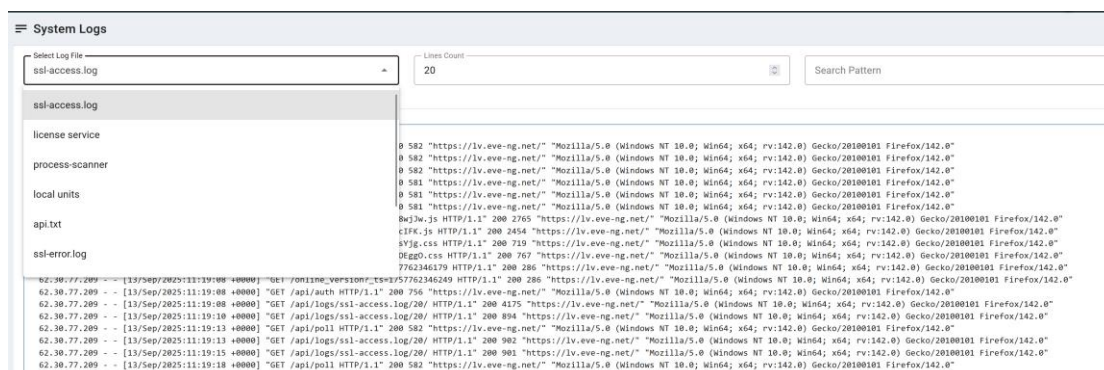

16.8 EVE cli diagnostic info

Use EVE cli to obtain your EVE information:

eve-info

This will collect all information and state about your EVE. Report file is stored: Report file:
/tmp/eve-info-eve-ng-20260621-144157.txt

17 EVE Extras

17.1 EVE Pro Login page customization

To customize EVE-NG Pro Login page you have to create custom information display file in location:

/opt/unetlab/html/custom.html

Content of this file is free of your choice how and what to add.

Example of custom.html file for Login page output with custom Logo and information:

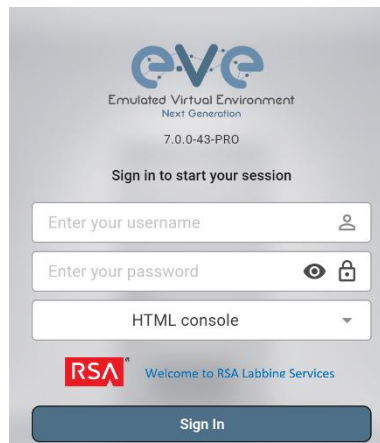

```
cat /opt/unetlab/html/custom.html
<figure class="table">
  <table>
    <tbody>
      <tr>
        <td>
          <figure class="image">
            
</figure>
</td>
<td>
<span style="color:hsl(210, 75%, 60%);margin-
left:10px;">Welcome to RSA Labbing Services</span>
</td>
</tr>
</tbody>
</table>
</figure>
```

17.2 EVE Pro Radius server setup for user authentication

⚠ Mandatory Prerequisites: Updated EVE-PRO version 2.0.6-30 or later.

Please follow section: [7.4.1](#)

RADIUS Settings

Primary Server

192 . 168 . 70 . 201 Port 1812 Secret ●●●●●●

Secondary Server

0 . 0 . 0 . 0 Port 1812 Secret ●●●●●●

17.2.1 EVE User setup for Radius authentication

Step 1: Open the User management submenu. Management>User management and click Add user

Step 2: The Add New User management window will pop up. Fill in the main information about your EVE user. Make sure that you're the username of the account created in EVE matches with the Radius server database.

Step 3: Select Authentication "radius". Any existing password will be removed, because the authenticator will check with the Radius server for credentials.

User Name*
test2

Password
●●●●●●

Confirm Password
●●●●●●

Authentication
radius

Step 4: If you have purchased licenses for different EVE user roles, you can choose the preferred user role. For licensing and user roles please refer to section [4](#)

Step 5: Set the access date and time From - to. If the fields are left empty (untouched), your user will have no time restrictions for accessing the EVE Server. Account validity with time settings is available for Editor and User roles only.

! Admin accounts have no time limit for account validity, and Account Validity time cannot be set. To remove Account validity, delete Date From and To, and put value “-1”

To remove Account validity, delete Date From and To, and put value “-1”

Step 6: The POD number is a value assigned to user accounts automatically. POD numbers are like user profiles inside of EVE and are a unique value for every user Think of PODs like a virtual rack of equipment for each user. Admins can assign a preferred number between 1-32786. Please keep POD numbers unique between users!

Step 7: Press Save SAVE CANCEL

Step 8. The username created inside EVE must match the username on the Radius server

Example: EVE user authenticated with Cisco ISE Radius server.

The screenshot shows the 'User management' interface in EVE-NG. At the top, there's a navigation bar with 'Professional', 'Main', 'Management', 'System', 'Information', 'User management', and '©2018 Eve-NG'. Below the navigation bar, the 'User management' section has a subtitle 'here you can manage EVE-NG users'. A table titled 'Database of users' contains the following data:

Username	Authenticator	Email	Name
admin	Internal	root@evec@host	Eve-NG Administrator
udise	radius	udise@evec.tlv	Udise Radius

An arrow labeled 'EVE Pro Radius user' points to the 'udise' row. Below the table, an 'Authentication Details' panel is open for the 'udise' user. It shows the following information:

- Source Timestamp: 2018-11-21 18:59:48.211
- Received Timestamp: 2018-11-21 18:59:48.214
- Policy Server: ISE2-1
- Event: 5200 Authentication succeeded
- Username: udise (highlighted with a red underline and an arrow labeled 'ISE 2.1 EVE Authenticated user')
- User Type: User
- Authentication Identity Store: Internal Users
- Authentication Method: PAP_ASCII
- Authentication Protocol: PAP_ASCII
- Network Device: EVE90-228
- Device Type: All Device Types
- Location: All Locations
- NAS IPv4 Address: 192.168.90.228
- Authorization Profile: PermAccess
- Response Time: 206

17.3 Active Directory user authentication

⚠ Mandatory Prerequisites: Updated EVE-PRO version 2.0.6-30 or later.

To join Active Directory to the EVE, please follow section: [7.4.1](#)

Active Directory Settings

Server

192 . 168 . 70 . 200 Port 389 TLS

Base DN

dc=eve,dc=lab

Active Directory Group

EVE Users

17.3.1 EVE User setup for AD (LDAP) authentication

Step 1: Open the User management submenu. Management>User management and click Add user

Step 2: The Add New User management window will pop up. Fill in the main information about your EVE user. Make sure that you're the username of the account created in EVE matches with the Radius server database.

Note: The username in of the Active directory user account must match with AD username. Username must have domain at the end of username. Example: **evelabuser@eve.lab**

Step 3: Select the Active Directory from Authentication menu. Any existing password will be removed, because the authenticator will check with the Active Directory server for credentials.

Step 4: If you have purchased licenses for different EVE user roles, you can choose the preferred user role. For licensing and user roles please refer to section 4

Step 5: Set the access date and time From - to. If the fields are left empty (untouched), your user will have no time restrictions for accessing the EVE Server. Account validity with time settings is available for Editor and User roles only.

! Admin accounts have no time limit for account validity, and Account Validity time cannot be set.

To remove Account validity, delete Date: From and To, and put value “-1”

Step 6: The POD number is a value assigned to user accounts automatically. POD numbers are like user profiles inside of EVE and are a unique value for every user Think of PODs like a virtual rack of equipment for each user. Admins can assign a preferred number between 1-32786. Please keep POD numbers unique between users!

Step 7: Press Save

Step 8. The username created inside EVE must match the username on the Radius server

17.4 Lab Chat

Lab Chat

Refer section: [7.9.14](#)

```
LAB CHATROOM
[10:42:52] uldis joined
[10:43:19] admin joined
[10:43:24] admin: hello uldis
[10:43:34] uldis: hello admin
```

17.5 Custom MAC address for node management

NOTE: Custom first MAC is supported for Qemu nodes only.

Qemu nodes has option to change first interface MAC address.

Additional Options

UUID

91386df0-f3d5-4212-95b9-ac20659bd456

First Eth MAC Address

20:22:00:0a:00:01

17.6 Windows node settings for Wifi dongle

Using a Wifi USB dongle, you can connect a WiFi-adaptor to windows host inside EVE.

Step 1. Connect your USB Wifi dongle to your EVE server.

Step 2. Issue the following command on the EVE CLI to obtain BUS and host numbers which your USB WiFi is connected to:

```
lsusb
```

```
root@eve-ng:~# lsusb
Bus 002 Device 002: ID 0cf3:9271 Atheros Communications, Inc. AR9271 802.11n
Bus 002 Device 001: ID 1d6b:0002 Linux Foundation 2.0 root hub
Bus 006 Device 001: ID 1d6b:0001 Linux Foundation 1.1 root hub
Bus 005 Device 001: ID 1d6b:0001 Linux Foundation 1.1 root hub
Bus 001 Device 003: ID 0424:2514 Standard Microsystems Corp. USB 2.0 Hub
Bus 001 Device 001: ID 1d6b:0002 Linux Foundation 2.0 root hub
Bus 004 Device 001: ID 1d6b:0001 Linux Foundation 1.1 root hub
Bus 003 Device 002: ID 04e6:5116 SCM Microsystems, Inc. SCR331-LC1 / SCR3310 Sma
rtCard Reader
Bus 003 Device 001: ID 1d6b:0001 Linux Foundation 1.1 root hub
root@eve-ng:~#
```

Step 3. Add the windows node onto the topology and edit the Qemu line:

Change the type value:

type=q35

Add a comma and then the following line:

if=virtio -usb -device usb-host,hostbus=2,hostaddr=2

Where hostbus is your Bus value and hostaddr is your Device ID as seen in the figure above.

Full Windows host qemu line will look like this:

```
-machine type=q35,accel=kvm -cpu
host,+pcid,+kvm_pv_unhalt,+kvm_pv_eoi,hv_spinlocks=0x1fff,hv_vapic,hv
_time,hv_reset,hv_vpindex,hv_runtime,hv_relaxed,hv_synic,hv_stimer -
vga std -usbdevice tablet -boot order=cd -drive
file=/opt/qemu/share/qemu/virtio-win-
drivers.img,index=1,if=floppy,readonly,if=virtio -usb -device usb-
host,hostbus=2,hostaddr=2
```

Additional Settings

QEMU Settings		
QEMU Version	QEMU Arch	QEMU Nic
4.1.0 (tpl)	x86_64 (tpl)	vmxnet3 (tpl)
QEMU custom options		
-machine type=pc,accel=kvm -cpu host -serial mon:stdio -nographic -no-user-config -nodefaults -rtc base=utc		

17.7 Master Server NIC ports order change

Some of the servers has Network interface cards with multi and various ethernet type ports. Example: Some DELL R series servers has first 2 Fibre ports (SFP) and additional 4 Ethernet ports. Requirement is to set EVE management on the 3rd port.

Supported starting from version 5.0.1-93.

Workaround:

- ❖ SSH or use serial console to your EVE CLI as root user.
- ❖ Navigate CLI to:

```
cd /opt/ovf/
```
- ❖ Run NIC order setup wizard

```
./nicorder-wizard
```
- ❖ Follow the instructions on the screen to set primary NIC for your EVE

```
Reorder Nics
*****
UP/DOWN      Select interface
LEFT/RIGHT  Move interface E VS Fixes
ESC         Discard change
ENTER       Accept new order

Name
> enx000c29617481 eth0 -> eth0
  enx000c2961748b eth1 -> eth1
```

- ❖ reboot your EVE to get new order in force

17.8 Satellite Server NIC ports order change

Some of the servers has Network interface cards with multi and various ethernet type ports. Example: Some DELL R series servers has first 2 Fibre ports (SFP) and additional 4 Ethernet ports. Requirement is to set EVE management on the 3rd port.

Workaround:

- ❖ SSH or use serial console to your EVE CLI as root user.
- ❖ Execute link set up command for all interfaces

```
ls -l /sys/class/net/ | while read i ; do ip link set $i up ; done
```

- ❖ Detect which interface is up state

```
ls -l /sys/class/net/ | while read i ; do echo $i $(ethtool $i | grep Link) ; done
```

```
root@eve-sat01:~# ls -l /sys/class/net/ | while read i ; do ip link set $i up ; done
root@eve-sat01:~# ls -l /sys/class/net/ | while read i ; do echo $i $(ethtool $i | grep Link) ; done
docker0 Link detected: no
ens160 Link detected: yes
ens192 Link detected: no
ens224 Link detected: yes
lo Link detected: yes
wgq0
```

- ❖ Edit netplan yaml file with correct interface name:

```
nano /etc/netplan/01-netcfg.yaml
```

```
GNU nano 4.8 /etc/netplan/01-netcfg.yaml
# This file describes the network interfaces available on your system
# For more information, see netplan(5).
network:
  version: 2
  renderer: networkd
  ethernets:
    ens160:
      addresses: [ "192.168.98.101/24" ]
      gateway4: 192.168.98.1
      nameservers:
        addresses: [ "8.8.8.8", "1.1.1.1" ]
```

- ❖ To save netplan settings use: CTRL +o [letter o]; Enter; CTRL +x [for exit]
- ❖ Run test the new network settings, enter

```
netplan try
```

```
root@eve-sat01:~# netplan try
Do you want to keep these settings?

Press ENTER before the timeout to accept the new configuration

Changes will revert in 112 seconds
Configuration accepted.
```

- ❖ Apply new network settings and reboot

```
netplan apply
```

```
reboot
```

18 Images for EVE

Images must be uploaded and prepared before they can be used in labs. The best way to upload images is to use the WinSCP tool for Windows environment or FileZilla for MAC OSX and Linux.

Link to download WinSCP:

<https://winscp.net/eng/download.php>

Link to download FileZilla:

<https://filezilla-project.org/>

To access EVE, use SSH protocol (port 22).

Supported images for EVE are stored in the three locations:

- IOL (IOS on Linux), **/opt/unetlab/addons/iol/bin/**
- Dynamips images, **/opt/unetlab/addons/dynamips**
- Qemu images, **/opt/unetlab/addons/qemu**

18.1 Qemu image naming table

⚠ IMPORTANT NOTE: Intel VT-X/EPT must be enabled to run Qemu nodes in EVE. For information on how to enable this option, Refer to section 3: EVE Installation.

The directory names used for QEMU images are very sensitive and must match the table below exactly in order to work.

Ensure your image folder name starts as per the table. After the "-" you can add whatever you like to label the image. We recommend using the version of your image.

Folder name examples:

[firepower6-FTD-6.2.1](#)
[acs-5.8.1.4](#)

The image hdd inside the folder must be named correctly:
Example: hda.qcow2 or virtioa.qcow2

Full path Example: `opt/unetlab/addons/qemu/acs-5.8.1.4/hda.qcow2`
The table of proper folder names is provided in our website:

<https://www.eve-ng.net/index.php/documentation/qemu-image-namings/>

Supported HDD formats and Qemu versions for the EVE images:

HDD Format	HDD name example
lsi([a-z]+).qcow	lsia.qcow
hd([a-z]+).qcow	hda.qcow
virtide([a-z]+).qcow	virtidea.qcow

virtio([a-z]+).qcow	virtioa.qcow
scsi([a-z]+).qcow	scsia.qcow
sata([a-z]+).qcow	sataa.qcow

Supported Qemu Versions
1.3.1
2.0.2
2.2.0
2.4.0
2.5.0
2.6.2
2.12.0
3.1.0
4.1.0
5.2.0
6.0.0
7.2.9
8.2.1
9.2.2

18.2 How to prepare images for EVE

How to add EVE-NG images please refer to:

<https://www.eve-ng.net/index.php/documentation/howtos/>

18.3 How to add custom image template

18.3.1 Templates folder choice

! IMPORTANT NOTE: Starting from EVE-PRO Version 2.0.6-42, EVE installation is autodetecting what kind of CPU manufacturer has your server: Intel or AMD, to choose proper templates set. You can check it manually on EVE cli: example below, showing that EVE has Intel CPU.

```
root@eve-ng:~# lsmod | grep ^kvm_
kvm_intel          212992    74
root@eve-ng:~#
```

- If you have Intel CPU, then your template files are in **"/opt/unetlab/html/templates/intel/"**
- If you have AMD CPU, then your template files are in **"/opt/unetlab/html/templates/amd/"**

18.3.2 Prepare template file

! NOTE: For templates development use templates folder which is matching your EVE server CPU.

Example below will be based for Intel CPU EVE custom image template. Use EVE cli or WinSCP/Filezilla to create template.

Step 1: Navigate to EVE location: /opt/unetlab/html/templates/intel/

Step 2: Choose your most suitable template from which you want to make copy and create own image template. (example: newimage.yml)

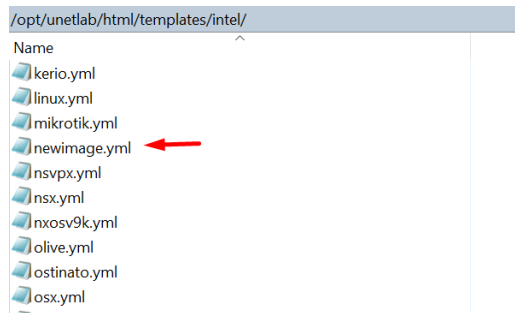

Step 3: Make a copy from source template newimage.yml. Example: Using CLI create template and name it ngips.yml.

```
cp /opt/unetlab/html/templates/intel/newimage.yml /opt/unetlab/html/templates/intel/ngips.yml
```

You can create new template using WinSCP or Filezilla as well.

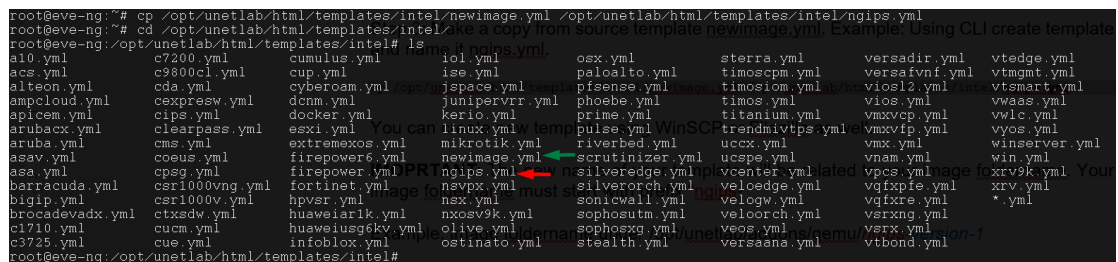

IMPORTANT: The new name of your template will be related to your image foldername. Your image foldername must start with prefix "ngips-"

Example: image foldername under /opt/unetlab/addons/qemu/ngips-6.5.0-115

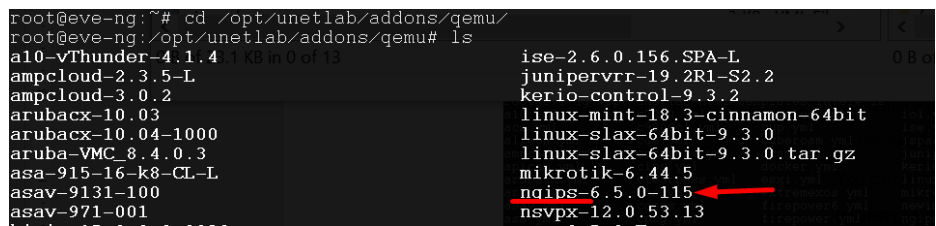

18.3.3 Prepare interface format and name lines

EVE Pro has included option to create various interface names, sequences and numbering. Please refer table below.

Formula	Template line format example	Will produce
---------	------------------------------	--------------

eth_format: <prefix>{<first value for slot: example 1>}<separator>{<first value for port>-<number of port per slot: example 8>}	eth_format: Gi{1}/{0-8}	Gi1/0 Gi1/1 Gi1/2 Gi1/3 Gi1/4 Gi1/5 Gi1/6 Gi1/7 Gi2/0 Gi2/1
eth_format: <prefix>{<first value for slot: example 0>}<separator>{<first value for port>-<number of port per slot: example 4>}	eth_format: Ge{0}/{0-4}	Ge0/0 Ge0/1 Ge0/2 Ge0/3 Ge1/0 Ge1/2 Ge1/3 Ge2/0 Ge2/1 Ge2/2
eth_format: <prefix>{<first value>}	eth_format: Gi{0}	Gi0 Gi1 Gi2 Gi3 ...
eth_format: <prefix>{<first value>}	eth_format: G0/{0}	G0/0 G0/1 G0/2 G0/3 ...
eth_name: <prefix: Interface custom name>	eth_name: - M1 - T1 - T2	M1 T1 T2
eth_name: <prefix: Interface custom name>	eth_name: - MGMT - DATA - TRAFFIC	MGMT DATA TRAFFIC

Combined first named interface following by formatted interfaces Example: We have to set first node interface name “eth0/mgmt” and next following interfaces must start from eth1 and change sequence accordingly. eth1, eth2,.....,ethx

As your node first interface will be custom named (eth0/mgmt), therefore in the template “eth_name:” must be added before “eth_format:”

```
eth_name:
- eth0/mgmt
eth_format: G{1}
```

This adding will produce Node interface names.

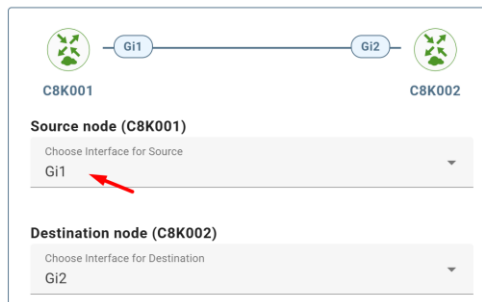

18.3.4 Edit your new template file:

For edit newly created template you can use WinSCP, FileZilla or cli. Example below shows template edit using cli and *nano* editor

```
cd /opt/unetlab/html/templates/intel/  
nano ngips.yml
```

Change content, setting for various images can vary depends of vendor requirements. The interface name lines please refer Section: [18.3.3](#)

```
# Copyright (c) 2016, Andrea Dainese  
# Copyright (c) 2018, Alain Degreffe  
# All rights reserved.  
#  
# Redistribution and use in source and binary forms, with or without  
# modification, are permitted provided that the following conditions are met:  
# * Redistributions of source code must retain the above copyright  
# notice, this list of conditions and the following disclaimer.  
# * Redistributions in binary form must reproduce the above copyright  
# notice, this list of conditions and the following disclaimer in the  
# documentation and/or other materials provided with the distribution.  
# * Neither the name of the UNetLab Ltd nor the name of EVE-NG Ltd nor the  
# names of its contributors may be used to endorse or promote products  
# derived from this software without specific prior written permission.  
#  
# THIS SOFTWARE IS PROVIDED BY THE COPYRIGHT HOLDERS AND CONTRIBUTORS "AS IS" AND  
# ANY EXPRESS OR IMPLIED WARRANTIES, INCLUDING, BUT NOT LIMITED TO, THE IMPLIED  
# WARRANTIES OF MERCHANTABILITY AND FITNESS FOR A PARTICULAR PURPOSE ARE  
# DISCLAIMED. IN NO EVENT SHALL <COPYRIGHT HOLDER> BE LIABLE FOR ANY  
# DIRECT, INDIRECT, INCIDENTAL, SPECIAL, EXEMPLARY, OR CONSEQUENTIAL DAMAGES  
# (INCLUDING, BUT NOT LIMITED TO, PROCUREMENT OF SUBSTITUTE GOODS OR SERVICES;  
# LOSS OF USE, DATA, OR PROFITS; OR BUSINESS INTERRUPTION) HOWEVER CAUSED AND  
# ON ANY THEORY OF LIABILITY, WHETHER IN CONTRACT, STRICT LIABILITY, OR TORT  
# (INCLUDING NEGLIGENCE OR OTHERWISE) ARISING IN ANY WAY OUT OF THE USE OF THIS  
# SOFTWARE, EVEN IF ADVISED OF THE POSSIBILITY OF SUCH DAMAGE.  
---  
type: qemu  
name: NGIPS ← Node name on the Topology  
description: Cisco FirePower NGIPS ← Node list name  
cpulimit: 1  
icon: IPS.png  
cpu: 4  
ram: 8192  
ethernet: 3  
eth name:  
- eth0/mgmt  
eth_format: eth{1}  
console: vnc  
shutdown: 1  
qemu_arch: x86_64  
qemu_version: 2.4.0
```

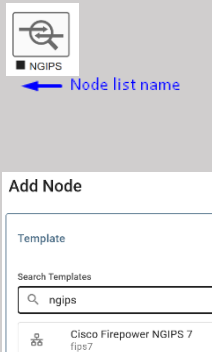

```
qemu_nic: e1000  
qemu_options: -machine type=pc,accel=kvm -serial none -nographic -no-user-config  
              -nodefaults -display none -vga std -rtc base=utc -cpu host  
...
```

Note: Qemu options in the line may vary per image requirements. Please check manufacturer advice how to run KVM image

18.3.5 Prepare new icon for your template:

Step 1 Use Filezilla or Winscp to copy your custom icon IPS.png (icon filename IPS.png used in ngips.yml)

This icon should be about 30-60 x 30-60 in the png format (switch.png is for example 65 x 33, 8-bit/color RGBA)

Step 2 Copy this new icon into /opt/unetlab/html/images/icons/

18.3.6 Template use

Step 1 Create directory /opt/unetlab/addons/qemu/ngips-6.5.0-115

```
mkdir /opt/unetlab/addons/qemu/ngips-6.5.0-115
```

Step 2 Upload image NGIPS, Refer Section: [18.2](#)

18.4 How to hide unused images in the node list

Please follow section [7.4.1](#) or [7.9.1.1](#)

19 EVE Backup Solution

EVE NG Software provides full and partial content backup Starting from:
EVE Professional 5.0.1-131 with Cluster
EVE Community 5.0.1-20
EVE Backup Solution supported transfer protocols: SFTP port 22 or FTP port 23.

EVE Backup solution requires to have an external SFTP/FTP server where the EVE-NG content will be stored. The SFTP/FTP server HDD size must be chosen appropriately.

19.1 Backup manager

19.1.1 Backup Manager Installation

- ⚠ **Mandatory Prerequisites:** The Internet must be reachable from your server. DNS names must be resolved. This Backup solution installation requires internet access to get updates and install the latest EVE-Professional or Community version from the EVE-NG repository.

SSH to your EVE as root user and execute following commands.

```
root@eve-ng:~# apt update
root@eve-ng:~# apt install eve-backup-manager
root@eve-ng:~# reboot
```

19.1.2 Setup external SFTP or FTP server

SFTP server setup is EVE user's responsibility and not covered under EVE-NG support.

In order to use the backup tool, you are required to set up an external SFTP/FTP server. This part is not supported by EVE-NG support, because every user can install and establish a server in its own way. The main pre-requisite is: The SFTP server must be reachable two ways from the EVE server and back from the SFTP server to EVE.

Examples of external SFTP server setup:

<https://www.eve-ng.net/wp-content/uploads/2024/03/EVE-Doc-2024-External-SFTP-Server.pdf>

19.1.3 Backup Manager SFTP/FTP settings

- ⚠ **IMPORTANT NOTE:** It's a must to stop all running labs (nodes) before starting a backup process. If you have satellites, then make sure they are and connected to the Master. Satellites backup will be done automatically.

SSH to your EVE as root user and execute following command.

```
root@eve-ng:~# backup-manager
```

```
-----Backup Manager Main Menu-----
(e) Edit Backup Server required to setup external SFTP/FTP server. This part is out of EVE-
(c) Create Backup NG support because every user can install and establish its own way. The main pre-requisite
(r) Restore Backup is the SFTP server must be fully reachable from EVE server and back from SFTP server to
(q) Quit as of external SFTP server setup:
Link to document

SFTP server setup is EVE user responsibility and not covered under EVE-NG support.
```

Select option (e) Edit Backup Server

```
Server Configuration-----
EVE-NG Professional Cookbook
Version 5.13
Server Protocol SFTP
Server Label store
Server Address 192.168.70.32
Remote Directory /sftpuser/
Username sftpuser
Password ***
Submit Quit
```

Server Protocol: Select your designated backup server protocol FTP or SFTP

Server Label: Name your Server Label, free to name it.

Server Address: Put your backup server IP,

Remote directory: For Linux servers, specify the target directory. The example above is /sftpuser/. This is the directory where the backup uploads will be stored. On the Windows SFTP server, this part can be left clear. All uploads will be stored in the sftp user-designated directory.

Username: Put your SFTP server username

Password: Put your SFTP user password

Submit

19.2 Create an EVE-NG Backup

SSH to your EVE as root user and execute following command.

```
root@eve-ng:~# backup-manager
```

Select option (c) Create Backup.

```
-----Backup Manager Main Menu-----
(e) Edit Backup Server Select option (e) Edit Backup Server
(c) Create Backup
(r) Restore Backup Page 288 of 290
(q) Quit
```

19.2.1 Backup option All

Every time when you run All backup process, EVE backup manager will create new backup folder [hostname]-[date]-[backup ID] with selected backup content.

Select your backup items:

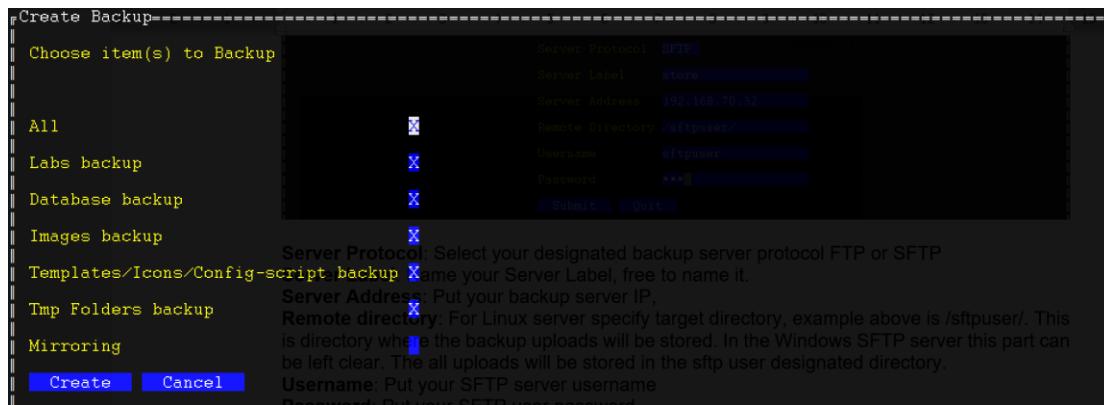

Select All: the backup manager will create directory with all contents of EVE which includes:

- Labs,
- Users Database,
- All images (Dynamips, IOL, Qemu),
- Templates of all images including Custom templates, config scripts and icons,
- TMP Folder (TMP folder contains all of your labs saved configurations and qemu nodes)

19.2.2 Backup option custom selected

Every time when you run a custom selected backup process, EVE backup manager will create new backup folder `[hostname]-[date]-[backup ID]` with selected backup content.

Select Custom items: For example, if you want to back up only labs, images and full labs with a tmp directory, your selection should look like the screenshot below.

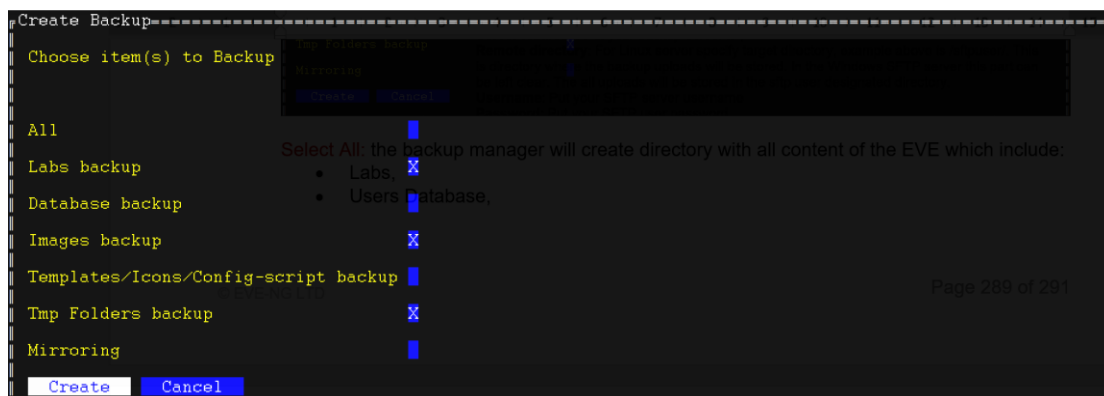

This backup folder will only contain Lab files (topologies), all images (vendor images) from the EVE in the current stage and the TMP folder (saved labs with all configurations) for all EVE users.

19.2.3 Backup option with Mirroring selected

First time when you run Mirror backup process, EVE backup manager will create new backup folder `"[hostname]-eve-ng-mirror"` with selected backup content.

Select Mirroring: The mirroring option creates a single Folder named `"[hostname]-eve-ng-mirror"`.

Using this option will only back up content of the new data added after the first backup. EVE Backup will compare data that already persists in the backup folder and will update only new items which have been changed after the backup is saved in the "[hostname]-eve-ng-mirror". It is recommended to select all items with a mirror option.

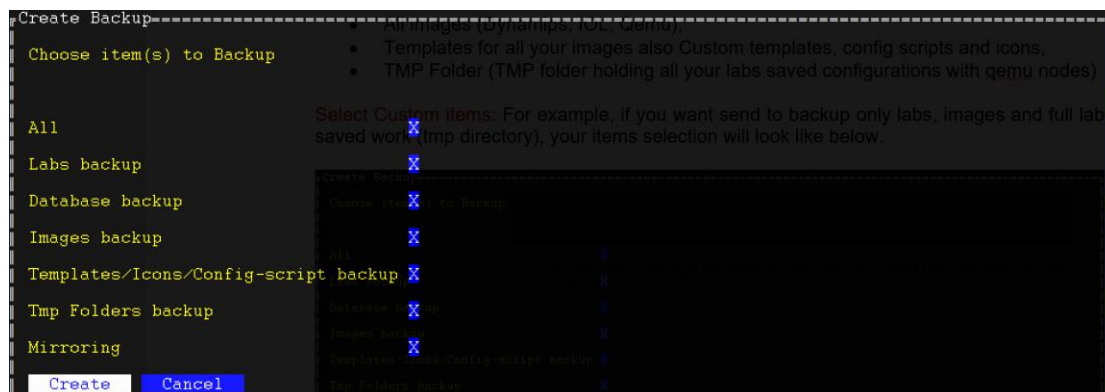

19.3 Restore data from EVE-NG Backup

SSH to your EVE as root user and execute following command.

```
root@eve-ng:~# backup-manager
```

Select option (r) Restore Backup.

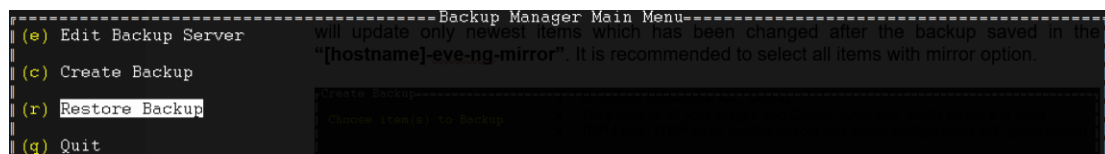

19.3.1 Select restore backup folder

IMPORTANT: Select a desired backup folder, following by Restore.

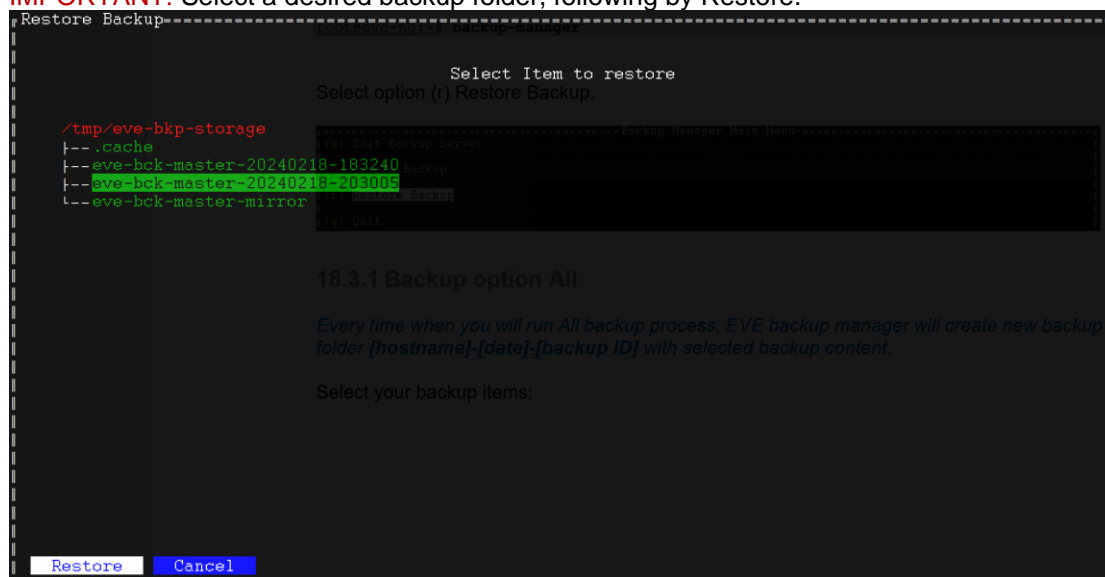

19.3.2 Select the items to restore

All: (Mirroring disabled) This option is useful to restore all data from backup to the new EVE installation. Backup manager will compare your existing data on your EVE with backup content and will restore only missing data.

Custom selected items: (Mirroring disabled) This option will restore custom selected items' data from backup to the new EVE installation. Backup manager will compare your existing data on your EVE with backup content and will restore only missing data.

Important: Restoring cluster satellite server TMP folder content for the new EVE install. Make sure that the Satellite ID matches your tmp-satellite folder number (ID)

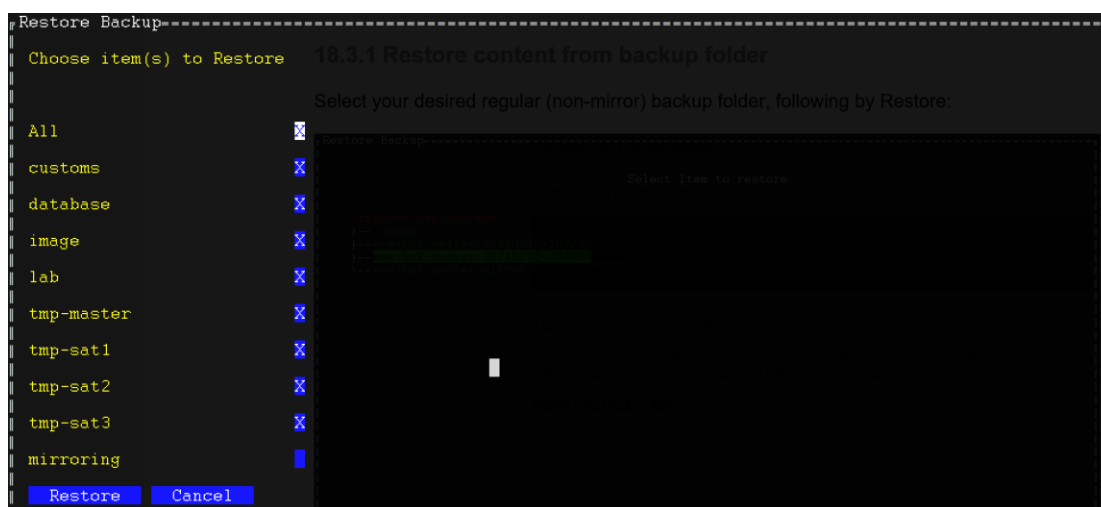

Careful! Mirroring enabled! This option will restore selected data from backup to the EVE installation. Backup manager will replace all data on your EVE with backup content and will destroy data which does not exist in backup.

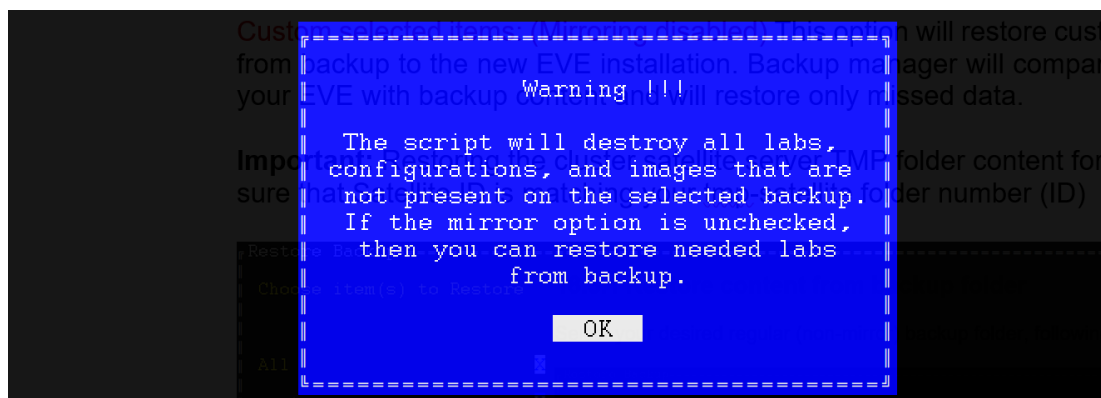

19.4 EVE-NG Backup session termination

In case you want stop/terminate started backup or restore, SSH to your EVE and use:

```
pkill eve_backup.sh
```

20 EVE Resources

For advanced users Only. You can find API documentation in your EVE PRO: **Error! Hyperlink reference not valid.** Please note, that any usage or EVE software amendment using this documentation is user responsibility and not covered by EVE-NG support.

For additional updated information please follow our web site: <https://www.eve-ng.net>

How to updates: <https://www.eve-ng.net/index.php/documentation/howtos/>

How to videos: <https://www.eve-ng.net/index.php/documentation/howtos-video/>

<https://www.eve-ng.net/index.php/documentation/knox-hutchinson-videos/>

How to create images : <https://www.eve-ng.net/index.php/documentation/howtos/>

FAQ: <https://www.eve-ng.net/index.php/faq/>

Live support chat: <https://webchat.eve-ng.net/login/> For access to live chat use your Google account or create new chat account.

EVE forum: <https://www.eve-ng.net/forum/> To access forum resources, please create a new forum account.

EVE YouTube channel:

<https://www.youtube.com/playlist?list=PLF8yvsYkPZQ0myW7aVMZ80k8FU04UUqjV>

EVE Professional downloads: <https://www.eve-ng.net/index.php/download/>

EVE Community version downloads, free: <https://www.eve-ng.net/index.php/community/>

EVE Supported images: <https://www.eve-ng.net/index.php/documentation/supported-images/>